

LONG-RANGE TAG/CARD READER KIT

DoorKing Part Number
1815-350

The DoorKing UHF tag/card reader is designed as a long range RFID reader using passive tag/card technology. Passive tag/card technology does not contain a battery in the tag/card so it will never wear out. The long range reader emits an RF signal which powers the tag/card when the tag/card enters the scanning area of the reader's antenna. The tag/card relays its Wiegand number back to the reader which reports the tag/card's number to the connected access control system. There is an interface module supplied with the reader that eliminates the need to set up the system using a computer. All necessary settings and adjustments can be made using the DIP and rotary switch on the reader's control board. It is an effortless way to open the gate for authorized vehicles. Mount an authorized tag/card on the car that the antenna is able to scan and the gate will open as the car approaches.

The system will work with 26-Bit Wiegand controllers. It uses frequency-hopping technology in the 902-928 MHz band (standard).

- Accessories sold separately:
- ISO Card UHF P/N 1508-190
 - UHF/DK Prox Dual Technology Card P/N 1508-198
 - Card Windshield Holder P/N 1815-318
 - Rear View Mirror Card Holder P/N 1815-319
 - Headlight/Windshield Tag P/N 1508-195
 - License Plate Tag P/N 1508-199

Modes of Operation

The UHF long range reader can operate in two different modes: **Timing** and **Trigger** mode which are selectable using SW2, DIP-switch 1 on the control board.

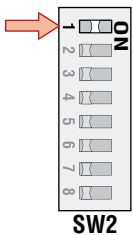

Timing Mode: If DIP-switch SW2, **switch 1** is set to the "OFF" position (left), the reader will work in **Timing** mode. It **WILL** attempt to read tag/cards that are within reading range at a rate determined by DIP-switch SW2, switches 2, 3 and 4. See other side for **Timing** mode wiring and DIP-switch settings.

Trigger Mode: If DIP-switch SW2, **switch 1** is set to the "ON" position (right), the reader will work in **Trigger** mode. It **WILL NOT** attempt to read tag/cards **UNLESS** the two trigger signal wires are shorted together (car on loop). Connect the dry contact relay wires of a vehicle loop detector to the loose red and black trigger wires on the long range antenna. See other side for "Optional" **Trigger** mode wiring and DIP-switch settings.

Installation

Position the antenna in the same plane as the mounted tag/card.

- Windshield mounted tag/card: Slant mounted antenna works best.
- Headlight Tag/License Plate Tag: Vertically mounted antenna works best.

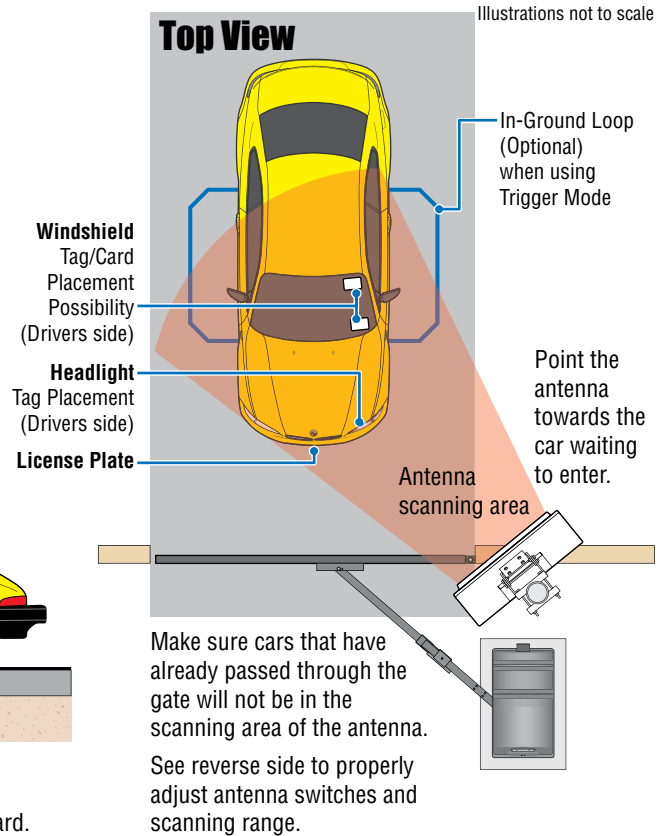
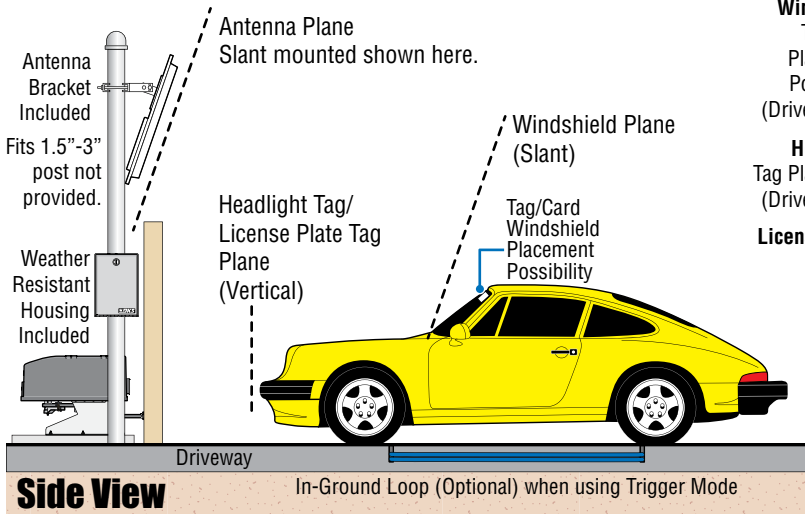

Tags/Card Placement on Cars: It should be placed on the side of the car (headlight/windshield) closest to where the antenna is located. The tags/card needs to be placed in **visual sight** of antenna or antenna can **NOT** read tags/card. **Never** place tags/card in a position that will block the drivers vision.

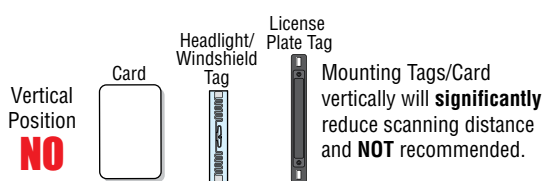
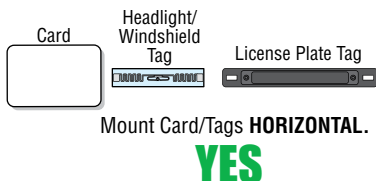

DKS
DOOR KING
120 S. Glasgow Avenue
Inglewood, California 90301 U.S.A.

Wiring

Optional Trigger Mode Wiring:

The long range reader will ONLY operate after the trigger signal wires (Blue and Black wires) have been activated by a vehicle on the in-ground loop.

All other wires from the antenna and reader circuit board are wired as shown below.

Black - **Trigger Mode ONLY**

Blue - **Trigger Mode ONLY**

SW2 DIP-Switch 1 **MUST** be ON

Normally Open (N.O.)
Dry Contact Relay
Vehicle Loop Detector

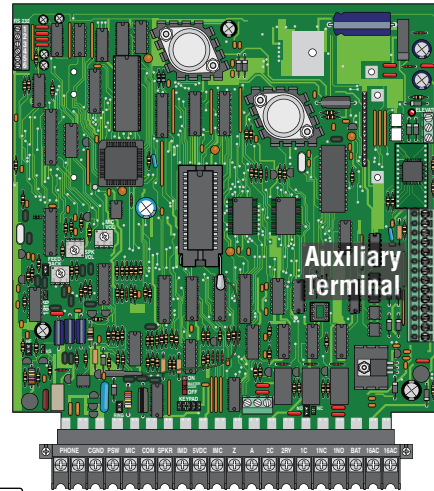
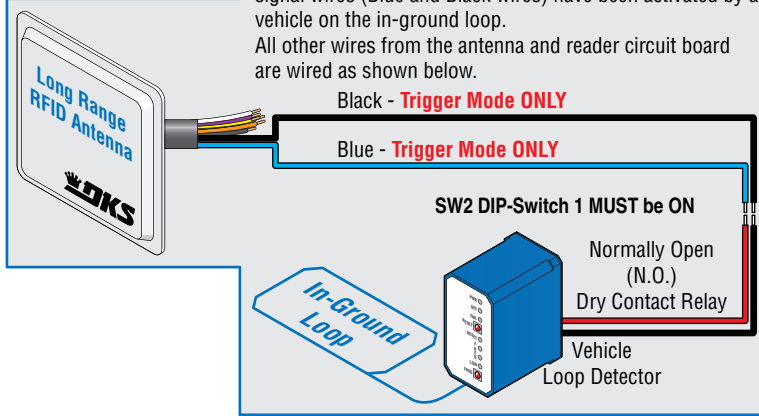

DoorKing 1830 Telephone Entry System Circuit Board

500 ft **MAX** length.
DO NOT use twisted wire.

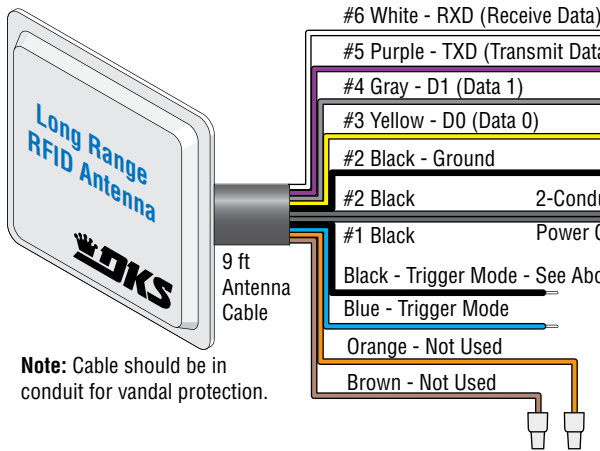

Note: Cable should be in conduit for vandal protection.

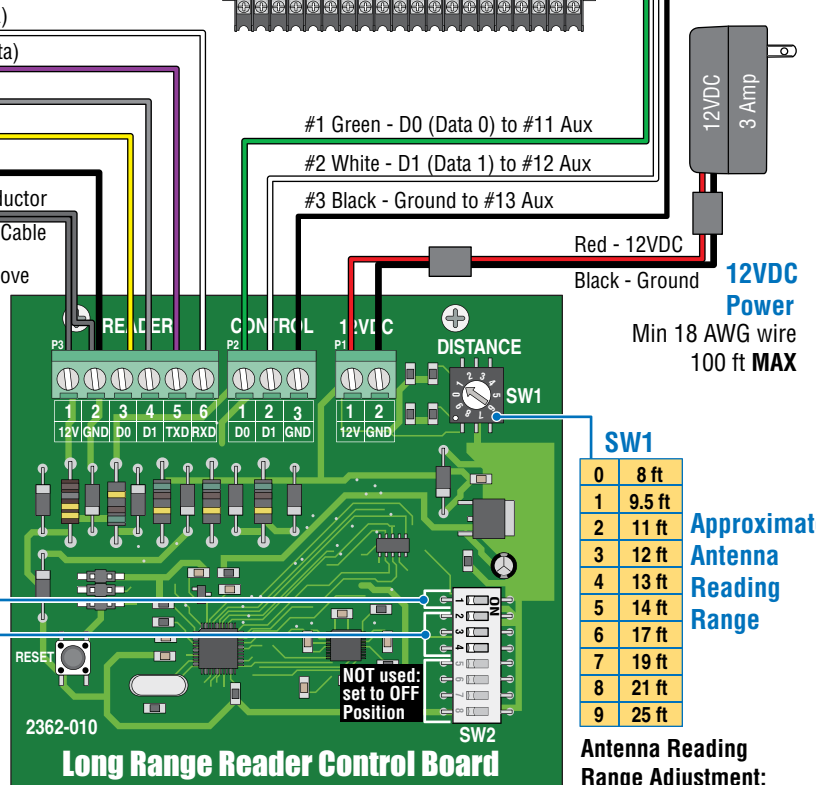

12VDC 3 Amp
Red - 12VDC
Black - Ground
12VDC Power
Min 18 AWG wire
100 ft **MAX**

SW2 DIP-Switch 1 Setting

- Switch 1 OFF - Timing Mode
- Switch 1 ON - Trigger Mode

Set for timing or trigger mode. See other side.

SW2 DIP-Switches 2-4 Settings

Switch 2	Switch 3	Switch 4	Time Interval
ON	ON	ON	0 sec (Test Mode)
OFF	ON	ON	1 sec
ON	OFF	ON	5 sec
OFF	OFF	ON	10 sec
ON	ON	OFF	15 sec
OFF	ON	OFF	20 sec
ON	OFF	OFF	25 sec
OFF	OFF	OFF	30 sec

Set the reader to eliminate redundant readings of the same tag/card at certain time intervals by using SW2 DIP-switches 2, 3 and 4 (**Note:** Switches 5-8 are NOT used). **Example:** If the switches are set to: switch 2-**ON**, switch 3-**OFF**, switch 4-**ON** the reader will read a tag/card, beep and report it to the access controller. For the next five (5) seconds, if it reads the same tag/card again, it will ignore it. It will not beep or report it to the access controller.

SW1	Approximate Antenna Reading Range
0	8 ft
1	9.5 ft
2	11 ft
3	12 ft
4	13 ft
5	14 ft
6	17 ft
7	19 ft
8	21 ft
9	25 ft

Antenna Reading Range Adjustment: Use the rotary switch (SW1). The reader will beep once after each change of range. It is also a good practice to put the system into "test mode" to benefit from the continuous beeping feature while adjusting the range.

Test Mode

SW2 DIP-switches 2, 3 and 4 **MUST** be set to the **ON** position (right). This will put the system in **test mode**. By choosing Timing/Trigger mode on DIP-switch 1, you can test in either operating mode. Test mode is used to calibrate and adjust the maximum reading range or maximum distance reader can read a tag/card. In timing test mode, reader sends out read signals at a default rate of 10Hz. After each successful tag/card read, you will hear a beep. As long as a tag/card is within range and in sight of the antenna, you will hear ten beeps per second. This feature helps when adjusting the reader's reading range, using the rotary switch SW1. In "trigger" test mode, the same is achieved in the presence of a valid trigger signal (car on loop).