

Operation Manual

(With installation instructions)

AIPHONE

Wireless video intercom

Device No. **WL-11.En**
n : Destination No

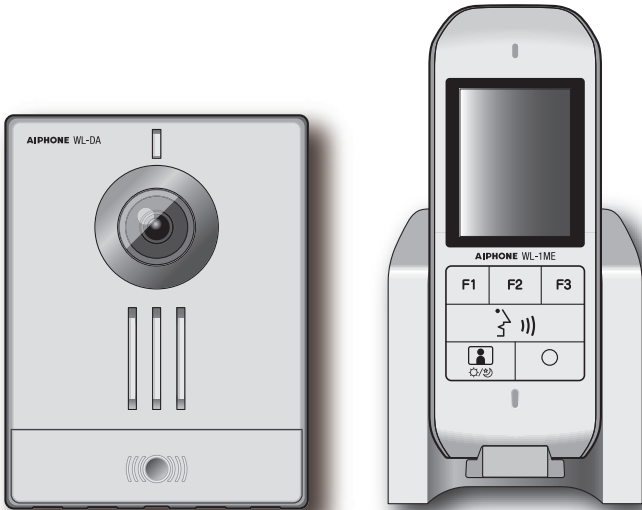

- Always charge the master station before use.
 - When the master station is not in use, always set it on the charging stand.
- 

Read this "Operation and Installation Manual " prior to usage to ensure safe and correct operation. Keep this in a safe place for future reference.

*The illustrations and images in this manual may vary from the actual items.

Use a nickel-hydrogen battery for the rechargeable battery. A nickel hydrogen battery is a valuable resource that can be recycled. Please recycle nickel-hydrogen batteries.



The warranty term of this product is two years.

Contents



Confirmation and Preparation

Features	3
Precautions	9
Package Contents	13
Part Names and Function	14
Master station.....	14
Screen.....	16
Video door station.....	18



Installation

Installing the video door station	19
Installing the charging stand	21
Charging the master station	22
Setting the Date and Time	23



Use

Receiving a call	24
Answering a door call and communicating...24	
Operations during placing a call and communication	25
Adjust video to enhance visibility (visibility correction).....	25
Switching the screen format.....	26
Recording video of the video door station	28
When the ambient noise is too loud to talk (Press-to-Talk).....	29
View outside	30
View (monitor) the entrance.....	30
Playing recordings	31
Playing recordings.....	31
Lock recordings.....	33
Deleting recordings.....	34



Configuration

Setting personal preferences	36
Setting and adjustment list.....	36
Sound settings.....	37
Master station settings.....	43
Video door station settings.....	45
Other settings.....	48



For ease-of-use

Checking the remaining battery level	50
Checking the remaining battery level of the video door station.....	50
Replacing batteries	51
Replacing the battery of the video door station.....	51
Replacing the battery pack of the master station.....	52
Cleaning	53
Charge only mode	53
Troubleshooting	54
Specifications	57
Caracteristiques Techniques	60

Features



Wireless master station with monitor
(Notation in this manual: **master station**)

- **Responding to a call from the entrance** (Page 24)

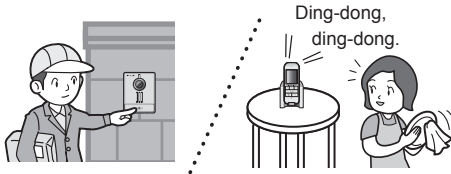

- **Checking recorded images** (Page 31)
- **Recording image of the entrance** (Page 28)

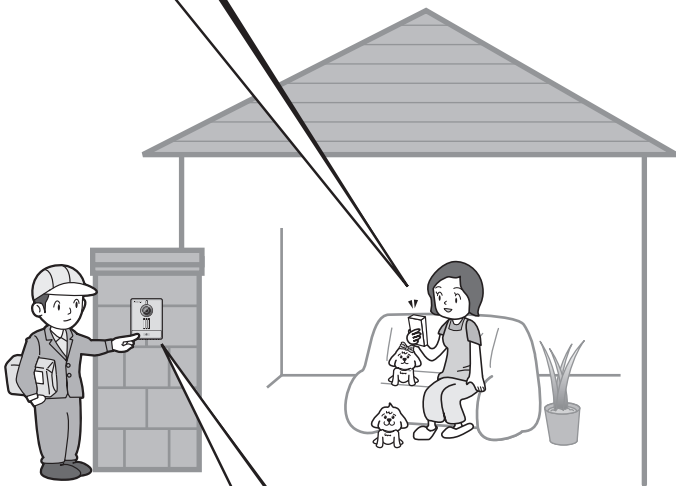

Wireless video door station with camera
(Notation in this manual: **video door station**)







- **Monitoring conditions outside** (Page 30)

Precautions

 : This symbol is intended to alert the user to cautions (including warnings and cautions).

    : This symbol is intended to alert the user to prohibited actions.   : This symbol is intended to alert the user to actions that are forced or instructed.

 : Signale des actions nécessitant une attention particulière (y compris les dangers).

    : Signale des actions interdites.   : Signale des instructions ou des actions qui doivent être obligatoirement effectuées.

Warning / Avertissement

- | | |
|---|---|
| <p> Do not dismantle or alter the unit.
May cause fire or electrical shock.</p> <p> Do not insert any objects into the unit through the openings.
Do not insert or drop any metal and flammable material into the unit.
Should this happen, disconnect the power adapter. May cause fire or electrical shock.</p> <p> Keep the unit and the charging stand away from water or any other liquid.
Should this happen, disconnect the power adapter. May cause fire or electrical shock.</p> <p> Do not touch the device during a thunderstorm.
Electric shock could result.</p> <p> If you notice smoke, a strange smell or a strange sound, or if the device is dropped or becomes damaged, disconnect immediately the power adapter.
Fire or electrical shock could result.</p> <p> Do not use with a power supply voltage above the specified voltage.
May cause fire or electrical shock.</p> <p> Do not use the device with a power adapter other than the one specified by Aliphone.
Fire or unit trouble could result.</p> <p> Do not plug or unplug unit with wet hands.
Electric shock could result.</p> <p> Periodically check for and remove dust on the power plug.
If dust is left, it could cause the power plug to heat up, resulting in fire. (Tracking)</p> <p> Insert AC plug completely and securely into AC outlet.
Otherwise, fire or electrical shock could result.</p> | <p> Do not handle the AC adapter cord as follows.
Otherwise, fire or electric shock may occur.</p> <ul style="list-style-type: none"> • Do not damage the AC adapter cord. • Do not modify the AC adapter cord. • Do not bend or twist the AC adapter cord. • Do not pull on the AC adapter cord. • Do not place heavy objects on the AC adapter cord. • Do not place the AC adapter cord near heating equipment. • If the AC adapter cord is damaged (exposed wires, broken, etc.), replace the cord. <p> Connect the power plug to an outlet that can be seen and that is easily accessible.
You must be able to easily disconnect the power plug in case of an emergency.</p> <p> Use a charger made or specified by Aliphone.
Using a charger not specified by Aliphone may cause a fire or damage the device.</p> <p> Do not charge the device when the charging terminals are wet.
May cause fire or electrical shock.</p> <p> Do not create a short circuit with the charging terminals using metal objects.
Fire or unit trouble could result.</p> <p> Do not use the device in the following environments.
Otherwise, it may cause interference or a malfunction.</p> <ul style="list-style-type: none"> • In a place where use of such device is prohibited, such as in a hospital • Near other electronic medical equipment (near an operating room, an intensive care unit, a coronary care unit, etc.) • Near automatic equipment, such as automatic doors or fire alarm systems • Not closer than 15 cm from where a cardiac pacemaker is implanted <p> The device is not designed to explosion-proof specifications. Do not install or use in an oxygen room or other such location filled with volatile gasses.
May cause fire or explosion.</p> |
| <p> Ne démontez pas et ne modifiez pas l'appareil.
Cela peut causer un incendie ou un choc électrique.</p> <p> N'insérez aucun objet à l'intérieur de l'appareil par les ouvertures.
N'insérez pas et ne laissez pas tomber des objets métalliques ou inflammables dans l'appareil.
Si un tel objet entre dans l'appareil, débranchez l'adaptateur secteur. Autrement, cela peut causer un incendie ou un choc électrique.</p> <p> N'insérez aucun liquide (eau, etc.) dans l'unité principale ou le chargeur, et ne les mouillez pas.
Si du liquide pénètre dans ces appareils, débranchez l'adaptateur secteur. Autrement, cela peut causer un incendie ou un choc électrique.</p> <p> Ne touchez pas l'appareil lors d'un orage.
Cela peut causer un choc électrique.</p> <p> Si de la fumée, une odeur inhabituelle ou un bruit inhabituel s'échappe de l'appareil, ou si l'appareil est tombé ou est endommagé, débranchez immédiatement l'adaptateur secteur.
Autrement, cela peut causer un incendie ou un choc électrique.</p> <p> N'utilisez pas l'appareil avec des tensions autres que celle spécifiée.
Cela peut causer un incendie ou un choc électrique.</p> <p> Utilisez uniquement l'adaptateur secteur spécifié par Aliphone.
Autrement, cela peut causer un incendie ou une panne.</p> <p> Ne touchez pas la fiche électrique avec des mains mouillées.
Brancher ou débrancher la fiche électrique avec des mains mouillées peut causer un choc électrique.</p> <p> Dépoussiérez régulièrement la fiche électrique.
Une fiche électrique poussiéreuse peut causer un incendie (phénomène de cheminement).</p> <p> Insérez complètement la fiche électrique dans la prise.
Une fiche électrique mal insérée peut causer un incendie ou un choc électrique.</p> | <p> Ne soumettez pas le câble d'alimentation aux traitements suivants.
Cela peut causer un incendie ou un choc électrique.</p> <ul style="list-style-type: none"> • N'endommagez pas le câble. • Ne modifiez pas le câble. • Ne pliez pas et ne tordez pas le câble de force. • Ne tirez pas sur le câble. • Ne placez pas d'objets lourds sur le câble. • Ne placez pas le câble près d'un objet générant de la chaleur, tel qu'un radiateur. • Si le câble est endommagé (les fils électriques sont visibles, le câble est coupé, etc.), demandez à le faire remplacer. <p> Branchez la fiche électrique dans une prise visible et à portée de main.
Il doit être possible de débrancher la fiche facilement en cas d'urgence.</p> <p> Utilisez uniquement des chargeurs fabriqués ou spécifiés par Aliphone.
Utiliser un chargeur non spécifié par Aliphone peut causer un incendie ou un choc électrique.</p> <p> Ne rechargez pas l'appareil lorsque les connecteurs de charge sont humides.
Cela peut causer un incendie ou un choc électrique.</p> <p> Ne créez pas de court-circuit avec les connecteurs de charges et un objet métallique.
Cela peut causer un incendie ou une panne.</p> <p> N'utilisez pas l'appareil dans les lieux ou les situations indiqués ci-dessous.
Cela peut provoquer des interférences ou un mauvais fonctionnement.</p> <ul style="list-style-type: none"> • Dans des endroits où de tels appareils sont interdits, tels que dans les hôpitaux • Près d'appareils médicaux électriques (près des salles d'opération, des unités de soins intensifs, des unités de soins coronariens, etc.) • Près d'appareils automatiques tels que les portes automatiques et les systèmes d'alerte incendie • À moins de 15 cm d'un endroit où un stimulateur cardiaque est installé <p> L'appareil n'est pas antifeu. Ne l'installez pas et ne l'utilisez pas dans une pièce contenant une grande quantité de gaz inflammable, tel que de l'oxygène.
Cela peut provoquer un incendie ou une explosion.</p> |

⚠ Caution / Attention

- ⊘ Do not put anything on or cover the unit with cloth, etc.
Fire or unit trouble could result.
- ⚠ Install the intercom unit in a position where it will not easily be brushed against by somebody's shoulder, etc.
Failure to do so could result in injury.
- ⊘ Do not install the device in a place subject to frequent vibrations or shocks or in an unstable location.
Otherwise, the device may fall or tilt and injure someone.
- ⊘ Do not bump or press firmly on the LCD.
Damage could result in injury.
- ⊘ If the LCD is punctured, do not touch the liquid crystal inside.
Skin inflammation could result.
- ⊘ If you accidentally ingest the liquid crystal, gargle and see a doctor.
If the liquid crystal gets in your eyes or on your skin, rinse with clean water thoroughly and see a doctor.
- ⊘ Do not put your ear close to the speaker when using the intercom.
Any sudden loud noise could hurt your ear.
- ⚠ Remove the batteries when not using the device for a long time.
Otherwise, the batteries may leak and damage the device.
- ⚠ Pay attention to the polarity and the indications when inserting the batteries inside the device.
Otherwise, the batteries may be damaged or leak.
- ⚠ Insulate the batteries with tape or other material when disposing of them.
Otherwise, a short circuit may occur with other metal material or batteries and cause a fire or a burst.
- ⚠ Check that nothing adheres to the device before using it.
The user may get injured if a thumb tack, a pin, a staple or other metal object adheres to the device or the speaker. It may also cause a problem such as the device not generating any sound.
- ⊘ Ne posez pas d'objets sur l'appareil et ne le recouvrez pas avec du tissu.
Cela peut causer un incendie ou une panne.
- ⚠ Installez l'unité principale à un emplacement où elle n'est pas susceptible d'être bousculée par des parties du corps, telles que les épaules.
Autrement, cela peut causer des blessures.
- ⊘ N'installez pas l'appareil dans un lieu sujet à de fréquentes vibrations ou à des chocs, ni dans un endroit qui n'est pas stable.
L'appareil pourrait tomber ou se renverser et blesser une personne.
- ⊘ N'appuyez pas avec force sur l'écran à cristaux liquides et ne le soumettez pas des chocs.
Un écran endommagé peut causer des blessures.
- ⊘ Si l'écran à cristaux liquides est endommagé, ne touchez sous aucun prétexte le liquide à l'intérieur.
Cela peut provoquer une inflammation de la peau.
* Si le liquide entre dans la bouche, rincez immédiatement la bouche et consultez un médecin.
* Si le liquide entre dans les yeux ou touche la peau, rincez abondamment la zone avec de l'eau propre, puis consultez un médecin.
- ⊘ N'approchez pas vos oreilles du haut-parleur lorsque vous utilisez l'appareil.
Vos oreilles pourraient être blessées en cas d'un bruit fort et soudain.
- ⚠ Retirez les piles si vous n'utilisez pas l'appareil pendant une longue période.
Le liquide des piles pourrait fuir et causer une panne.
- ⚠ Faites attention à la polarité (plus et moins) et respectez les indications lorsque vous insérez les piles dans l'appareil.
Autrement, les piles pourraient s'endommager et fuir.
- ⚠ Lorsque vous jetez les piles, insolvez-les avec du ruban adhésif ou un autre moyen.
Autrement, les piles pourraient créer un court-circuit au contact d'objets métalliques ou d'autres piles et causer un incendie ou un éclatement.
- ⚠ Vérifiez qu'aucun objet n'est collé à l'appareil avant de l'utiliser.
Vous pourriez vous blesser si une punaise, une aiguille, une agrafe ou un autre objet métallique est collé à l'appareil ou à l'aimant du haut-parleur. De tels objets peuvent également causer une panne, tels qu'une absence de son.

■ Handling of rechargeable batteries and other batteries to be used / ■ Manipulation des batteries rechargeables et autres piles à utiliser

⚠ Danger / Danger

Do not perform the following actions. There is a risk of burns and injuries from liquid leaks, heat generation, and explosions of rechargeable batteries and other batteries. Observe the following points when charging a rechargeable battery or using a rechargeable battery or other battery.

- ⊘ Do not use an unspecified rechargeable battery with the master station.
 - Do not use a battery with the plus (+) and minus (-) ends reversed.
 - Use the included battery pack as a rechargeable battery for the master station only. Do not use it with other devices.
 - Install the included battery pack on the master station, and then charge it with the dedicated charging stand. Do not charge it using another charging stand.
 - Do not place a battery in a fire or heat a battery.
 - Do not disassemble, modify, or add solder.
 - Do not contact the plus (+) and minus (-) ends with a needle or other metal object.
 - Do not pinch or damage the rechargeable battery cord with the battery cover.
 - Do not carry or store a battery together with a metal necklace, hairpin, or similar object.
- ⚠ The liquids of rechargeable batteries and other batteries are dangerous to the eye.
There is a risk of blindness. If liquid enters the eye, do not rub the eye. Instead rinse with water, and then receive medical treatment from a doctor immediately.
- N'effectuez pas les opérations suivantes, en raison de risques de brûlures ou de blessures dues à une fuite de liquide, à une émission de chaleur, ou à l'explosion des batteries rechargeables ou des piles. Lorsque vous rechargez une batterie rechargeable ou utilisez une batterie rechargeable ou une autre pile, respectez les points suivants.
 - ⊘ N'utilisez pas une batterie rechargeable non spécifiée avec le combiné.
 - N'inversez pas les bornes plus (+) et moins (-) de la batterie ou de la pile lors de l'utilisation.
 - Utilisez la batterie fournie en tant que batterie rechargeable pour le combiné uniquement. Ne l'utilisez pas avec d'autres appareils.
 - Installez la batterie fournie dans le combiné, puis rechargez-la avec le chargeur prévu à cet effet. Ne la rechargez pas avec un autre chargeur.
 - Ne mettez pas une batterie ou une pile dans le feu, ne la chauffez pas.
 - Ne démontez pas la batterie ou les piles, ne les modifiez pas, et n'ajoutez pas de soudure.
 - Ne faites pas entrer les bornes plus (+) et moins (-) en contact avec une aiguille ou tout autre objet métallique.
 - Ne pincez pas et n'endommagez pas le fil de la batterie rechargeable avec le couvercle du combiné.
 - Ne transportez pas et ne conservez pas une batterie ou une pile avec un collier en métal, une épingle à cheveux ou tout objet similaire.
- ⚠ Les liquides des batteries rechargeables et des piles sont dangereux pour les yeux.
Ils peuvent causer la cécité. Si le liquide entre en contact avec les yeux, ne frottez pas les yeux. Rincez plutôt à l'eau et consultez immédiatement un médecin.

⚠ Warning / Avertissement

<p> Do not peel or scratch the exterior tubing of the rechargeable battery or other battery. This can generate smoke or fire.</p> <p> Do not splash with or immerse in freshwater or ocean water. This can cause heat generation or rust of the rechargeable battery or other battery.</p> <p> Do not use batteries of different conditions together. New and old, different types (rechargeable and dry cell, alkali and manganese, etc.), different brands, different capacities, different charging states (in the case of rechargeable batteries), etc.</p> <p> Do not charge dry cell batteries.</p> <p> If you notice something unusual, such as odors, discoloration, or deformation, remove the rechargeable battery or battery from the equipment and discontinue use. Otherwise, heat generation or an explosion may occur.</p> <hr/> <p> Ne dévinez pas et n'égratignez pas la gaine extérieure de la batterie rechargeable ou des autres piles. Cela peut générer de la fumée ou des flammes.</p> <p> N'exposez pas la batterie ou les piles à des jets d'eau et ne les plongez pas dans de l'eau douce ou de l'eau de mer. Cela peut causer une émission de chaleur ou de la rouille sur la batterie rechargeable ou les piles.</p> <p> N'utilisez pas ensemble des batteries ou des piles dont les conditions sont différentes. Batteries ou piles neuves et vieilles, de différents types (rechargeable et pile sèche, alcaline et manganèse, etc.), de marques différentes, de capacités différentes, de niveaux de charge différents (dans le cas de batteries ou de piles rechargeables), etc.</p> <p> Ne rechargez pas des piles sèches.</p> <p> Si vous remarquez une anomalie, telle qu'une odeur, une décoloration ou une déformation, retirez la batterie rechargeable ou les piles de l'appareil et cessez de l'utiliser. Autrement, cela peut causer une émission de chaleur ou une explosion.</p>	<p> If a liquid of a rechargeable battery or battery adheres to skin or clothing, wash the area immediately with clean water. The liquid may cause skin disorders.</p> <p> If the remaining power is low, replace the battery.</p> <p> Strictly observe the expiry dates of batteries.</p> <p> Immediately remove batteries that can no longer be used.</p> <p> Remove batteries from equipment when it will not be used for an extended period.</p> <p> Keep away from fire when liquid leaks or offensive smells are present.</p> <hr/> <p> Si le liquide d'une batterie rechargeable ou d'une pile entre en contact avec la peau ou les vêtements, rincez immédiatement la zone concernée à l'eau claire. Le liquide peut causer des troubles de la peau.</p> <p> Remplacez la batterie ou les piles lorsqu'elles sont presque déchargées.</p> <p> Respectez strictement les dates de limite d'utilisation des batteries ou des piles.</p> <p> Retirez immédiatement la batterie ou les piles qui sont hors d'usage.</p> <p> Retirez la batterie ou les piles de l'appareil si celui-ci n'est pas utilisé pendant une longue durée.</p> <p> En cas de fuite de liquide ou d'odeur forte, gardez à l'abri des flammes.</p>
---	--

⚠ Caution / Attention

<p> Do not apply strong impacts or throw the product. This can cause liquid leaks, heat generation, or explosion of the rechargeable battery or battery.</p> <p> The charging temperature range of the rechargeable battery is 0 through 40°C. Charging outside this temperature range may cause liquid leaks, heat generation, or a reduction in performance or lifetime of the rechargeable battery.</p> <p> N'appliquez pas de choc important sur le produit, ne le jetez pas. Cela peut causer une fuite de liquide, une émission de chaleur ou une explosion de la batterie rechargeable ou des piles.</p> <p> La gamme appropriée de températures pendant le rechargement est de 0 à 40 °C. Recharger hors de cette gamme peut causer une fuite de liquide, une émission de chaleur ou une réduction des performances ou de la durée de vie de la batterie rechargeable.</p>	<p> Do not use or leave the product in a high temperature location. This can cause liquid leaks, or decreases in performance or lifetime of the rechargeable battery or battery.</p> <p> Store rechargeable batteries and other batteries out of the reach of infants and take care not to allow infants to remove them from equipment.</p> <p> Risk of explosion if battery is replaced by an incorrect type. Dispose of used batteries according to the instructions.</p> <hr/> <p> N'utilisez pas et ne laissez pas le produit dans un endroit où la température est élevée. Cela peut causer une fuite de liquide, ou diminuer les performances ou la durée de vie de la batterie rechargeable ou des piles.</p> <p> Conservez la batterie rechargeable et les piles hors de portée des jeunes enfants et veillez à ce que les jeunes enfants ne les retirent pas de l'appareil.</p> <p> Risque d'explosion si la batterie est remplacée par une batterie non conforme. Jetez les piles usagées conformément à la législation.</p>
--	--

When monitoring or talking master station and video door station, please use the product at least 20 cm (8 inch) away from your body.
Lors de la manipulation de l'interphone ou lorsque vous parlez de son combiné, maintenez le produit à au moins 20 cm de votre corps.

Considerations during use

Installation

Do not install in the following locations (master station)

- Near fire, heaters, and humidifiers (cause deformation and malfunctions)
- Near televisions, radios, personal computers, and other office devices, air conditioners, water heater remote controls (with intercom functions), and home security related equipment (cause noise)
- Within about 3 m of other wireless devices (cause electromagnetic interference)
- In direct sunlight or near air-conditioning equipment (cause malfunctions, deformations, and breakdowns when the temperature is above 40°C or below 0°C)
- Locations with large temperature changes (condensation causes malfunctions)
- Charging stand of the master station



- Do not place near an AM radio (causes static on the AM radio.)
- Do not place near televisions, speakers, and other items that generate electromagnetic waves or magnetism (Charging may not be possible.)

Insert the power plug into an outlet nearby the installation location so that it can be inserted and removed easily.

Communication of master station and door station

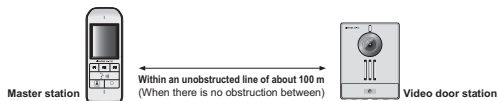

- If the distance is too far or the following obstacles are present within about 100 m, the reception weakens, which may cause static, communication disconnections, video chopiness, and refresh delays such that usage may not be possible.

- A metal door or storm shutter
- A wall that includes heat insulating material that contains aluminum foil
- A concrete or galvanized sheet iron wall
- A window with multi-layered glass
- A location separated by many walls
- When using each device at a separate floor or building

- Use within range of reception.

[Communication by a master station and door station]

- This product uses digital signals that are difficult to monitor, but because radio waves are used, there are cases in which a third-party could intercept signals intentionally.
- If you use a hearing aid, static may be heard depending on the type of hearing aid.
- If a 1.9 GHz digital cordless phone or personal handphoned system is used nearby, the product may not operate normally.

FCC

FCC Information

FCC Part 15

This equipment has been tested and found to comply with the requirements for a Class B digital device under Part 15 of the Federal Communications Commission (FCC) rules. These requirements are intended to provide reasonable protection against harmful interference in a residential installation. This equipment generates, uses and can radiate radio frequency energy and, if not installed and used in accordance with the instructions, may cause harmful interference to radio communications. However, there is no guarantee that interference will not occur in a particular installation. If this equipment does cause harmful interference to radio or television reception, which can be determined by turning the equipment off and on, the user is encouraged to try to correct the interference by one or more of the following measures:

- Reorient or relocate the receiving antenna.
- Increase the separation between the equipment and receiver.
- Connect the equipment into an outlet on a circuit different from that to which the receiver is connected.
- Consult the dealer or an experienced radio/TV technician for help.

Changes or modifications to this equipment not expressly approved by the party responsible for compliance could void the user's authority to operate the equipment.

This device complies with Part 15 of the FCC rules. Operation is subject to the following two conditions:

- (1) this device may not cause harmful interference, and
- (2) this device must accept any interference received, including interference that may cause undesired operation. Privacy of communications may not be ensured when using this telephone.

To ensure safety of users, the FCC has established criteria for the amount of radio frequency energy that can be safely absorbed by a user or bystander according to the intended usage of the product. This product has been tested and found to comply with the FCC criteria. To comply with FCC RF exposure requirements, the device must be installed and operated 20 cm (8 inches) or more between the product and all person's body.

ISED

Innovation, Science and Economic Development Canada Notices and other information

CAN ICES-3 (B)/NMB-3 (B)

This device complies with Industry Canada's licence-exempt RSSs. Operation is subject to the following two conditions:

- (1) This device may not cause interference; and
- (2) This device must accept any interference, including interference that may cause undesired operation of the device.

Le présent appareil est conforme aux CNR d'Industrie Canada applicables aux appareils radio exempts de licence. L'exploitation est autorisée aux deux conditions suivantes :

- (1) l'appareil ne doit pas produire de brouillage;
- (2) l'utilisateur de l'appareil doit accepter tout brouillage radioélectrique subi, même si le brouillage est susceptible d'en compromettre le fonctionnement.

RF Exposure Information (SAR) / Informations d'exposition RF (SAR)

For Monitor unit:

Highest Specific Absorption Rate (SAR) values 1g-SAR for body: 0.21 W/kg

This product is designed and manufactured not to exceed the emission limits for exposure to radio frequency (RF) energy set by the Federal Communications Commission of the United States.

For Camera unit:

Important safety information regarding radio frequency (RF) radiation exposure: RF exposure guidelines require that the device be used at a minimum of 20 cm from the human body.

Pour le poste intérieur:

Valeur d'absorption spécifiques les plus élevées (SAR) 1g-SAR pour le corps: 0,21 W / kg.

Ce produit est conçu et fabriqué pour ne pas dépasser les limites d'émission d'exposition à l'énergie radiofréquence (RF) définies par la Commission fédérale des communications des États-Unis.

Pour la platine de rue:

Informations importantes de sécurité concernant l'exposition aux radiofréquences (RF): Les directives sur l'exposition aux radiofréquences exigent que l'appareil se trouve à au moins 20 cm du corps humain.

Precautions

Communication of master station and door station

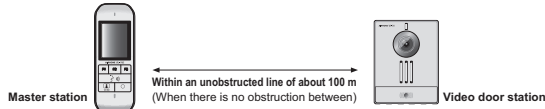

- If the distance is too far or the following obstacles are present within about 100 m, the reception weakens, which may cause static, communication disconnections, video choppiness, and refresh delays such that usage may not be possible.

- Metal door or storm shutter
- A wall that includes heat insulating material that contains aluminum foil
- A concrete or galvanized sheet iron wall
- A window with multi-layered glass
- A location separated by many walls
- When using each device at a separate floor or building

- Use within range of reception.

[Communication by a master station and door station]

- This product uses digital signals that are difficult to monitor, but because radio waves are used, there are cases in which a third-party could intercept signals intentionally.
- If you use a hearing aid, static may be heard depending on the type of hearing aid.
- If a 1.9 GHz digital cordless phone or personal handyphone system is used nearby, the product may not operate normally.

EU

RE Directive

Hereby, AIPHONE declares that the radio equipment is in compliance with Directive 2014/53/EU. The full text of the EU declaration of conformity is available at the following internet address: www.aiphone.net

Important safety information / Informations importantes de sécurité

For Monitor unit:

This product is designed a low-power radio transmitter and receiver. As recommended by international guidelines, the device is designed not to exceed the limits for exposure to radio waves.

For Camera unit:

Important safety information regarding radio frequency (RF) radiation exposure: RF exposure guidelines require that the device be used at a minimum of 20 cm from the human body.

Pour le poste intérieur:

Ce produit est conçu comme un émetteur-récepteur radio de faible puissance. Comme recommandé par les directives internationales, les appareils sont conçus pour ne pas dépasser les limites d'exposition aux ondes radio.

Pour la platine de rue:



Informations importantes de sécurité concernant l'exposition aux radiofréquences (RF): Les directives sur l'exposition aux radiofréquences exigent que l'appareil soit utilisé à au moins 20 cm du corps humain.

Precautions





■ Handling of rechargeable batteries and other batteries to be used

Hazard





Do not perform the following actions. There is a risk of burns and injuries from liquid leaks, heat generation, and explosions of rechargeable batteries and other batteries. Observe the following points when charging a rechargeable battery or using a rechargeable battery or other battery.

-  • Do not use an unspecified rechargeable battery with the master station.
-  • Do not use a battery with the plus (+) and minus (-) ends reversed.
- Use the included battery pack as a rechargeable battery for the master station only. Do not use it with other devices.
- Install the included battery pack on the master station, and then charge it with the dedicated charging stand. Do not charge it using another charging stand.
- Do not place a battery in a fire or heat a battery.
- Do not disassemble, modify, or add solder.
- Do not contact the plus (+) and minus (-) ends with a needle or other metal object.
- Do not pinch or damage the rechargeable battery cord with the battery cover.
- Do not carry or store a battery together with a metal necklace, hairpin, or similar object.
-  • The liquids of rechargeable batteries and other batteries are dangerous to the eye. There is a risk of blindness. If liquid enters the eye, do not rub the eye. Instead rinse with water, and then receive medical treatment from a doctor immediately.

Warning

-  Do not peel or scratch the exterior tubing of the rechargeable battery or other battery.
This can generate smoke or fire.
-  Do not splash with or immerse in freshwater or ocean water.
This can cause heat generation or rust of the rechargeable battery or other battery.
-  If you notice something unusual, such as odors, discoloration, or deformation, remove the rechargeable battery or battery from the equipment and discontinue use.
Otherwise, heat generation or an explosion may occur.
-  If a liquid of a rechargeable battery or battery adheres to skin or clothing, wash the area immediately with clean water.
The liquid may cause skin disorders.

Caution

-  Do not apply strong impacts or throw the product.
This can cause liquid leaks, heat generation, or explosion of the rechargeable battery or battery.
-  The charging temperature range of the rechargeable battery is 0 through 40°C. Charging outside this temperature range may cause liquid leaks, heat generation, or a reduction in performance or lifetime of the rechargeable battery.
-  Do not use or leave the product in a high temperature location.
This can cause liquid leaks, or decreases in performance or lifetime of the rechargeable battery or battery.
-  Store rechargeable batteries and other batteries out of the reach of infants and take care not to allow infants to remove them from equipment.

Precautions

Warning

- **Keep the unit more than 3m away from radios or TVs.**
- **Please keep the unit at least 20 cm away from wireless devices such as wireless routers, or cordless telephones.**
Such devices may cause the image or sound distortion.
- **Move to within 30 cm of the master station for communication.**
Standing too far away may make it difficult for the other party to hear the communication.
- **Do not use in a bathtub or shower stall.**
Unit malfunction could result.
- **If the unit malfunctions or an abnormality occurs, pull out the power plug.**
- **When installing or using the intercom, consider to the privacy as the responsibility of the customer.**
- **To prevent unexpected problems resulting from the release of customer information stored in this unit, delete the settings recorded images and audio, and all other recorded data before disposing of, transferring, or returning the unit as customer's responsibility.**
To delete the information, refer to "Initializing the settings" (page 46).
- **Do not install the master station under direct sunlight.**
If installation in such locations is necessary, shield the unit from sunlight.
The screen may become difficult to view.
- **Please mount the Video Door Station perpendicular to the ground.**
If the Video Door Station is mounted at an angle, rain water could seep into the Video Door Station and cause damage.
- **The Video Door Station is splash-proof, but do not expose it directly to sprinkling water.**
Device malfunction could result.

Notes

- **Aiphone is not responsible for damage caused by the content of this product or its specifications.**
- **Aiphone is not responsible for damage caused by failures, defects, or operation mistakes of this product.**
- **If the intercom is used in areas where there are business-use wireless devices such as a transceiver or mobile phones, it may cause malfunction.**
- **If the intercom is installed close to a light dimmer, an inverter electrical appliance, it may create interference and cause a malfunction.**
- **If the intercom is installed in an area with an extremely strong electrical field, such as in the vicinity of a broadcasting station, it may create interference and cause a malfunction.**
- **The base unit is intended for indoor use only. Never use outdoors.**
- **The unit may pick up stray broadcasts in buildings located near broadcast stations.**

- It must be noted in advance that the LCD panel, though manufactured with very high precision techniques, inevitably will have a very small portion of its picture elements always lit or not lit it at all. This is not a malfunction.
- Hands-free calling prioritizes the loud side and switches between transmission and reception automatically. The quiet side can be heard. If there are loud noises around the unit, the sound may break up and be difficult to hear.
- During communication, if you speak before the other person has finished talking, your voice may not come through clearly. Allow each person to finish speaking before responding.
- Warm-color lighting shining on the video door station may change the tint of the image on the screen.
- If light, such as illumination, enters the camera, the liquid crystal display may flicker brightly or objects may appear dark due to backlight interference. This is not a malfunction.
- If the subject has a line pattern or thin pattern, background or color may differ from the actual images. This is not a malfunction.
- If the video door station is subject to direct sunlight or other strong light, white lines may appear on the liquid crystal display and reflected patterns may appear due to the light. It makes difficult to see the face of the visitor. This is not a malfunction.
- If glare from an LED light or fluorescent light, etc. enters the camera, black stripes may appear on the liquid crystal display of the master station, the screen may flicker, and colors may differ. This is not a malfunction
- The discrimination between day and night is performed automatically by the video door station. Though the discrimination result may vary depending on the installation environment, it is not a malfunction.
- At night, due to reduced lighting on the object, the screen sees more noise and faces become more difficult to see. This is not a malfunction.
- When outside temperature lowers sharply after rainfall, etc., the inside of the camera may fog up slightly, causing a blurry images, but this is not a malfunction.
Normal operation will be restored when moisture evaporates.
- Aiphone assumes no responsibility for corruption of saved information (such as changes to or deletion of saved information).
- Freezing conditions may affect the video quality and button functionality.
- Fluorescent lights may cause periodic image distortion (color rolling). This is not a malfunction.
- Aiphone assumes no responsibility for corruption of saved information (such as changes to or deletion of saved information).
- Freezing conditions may affect the video quality and button functionality.

Precautions

- If warm air from inside the room enters the unit, the internal and external temperature difference may cause condensation on the camera. Plugging of cable holes and other gaps where warm air might enter is recommended for preventing condensation.
- If the master station is turned off, the date and time will return to the default settings.





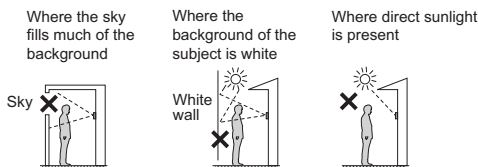

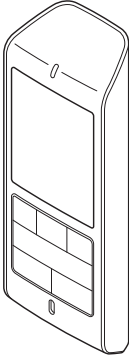
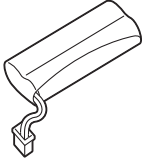
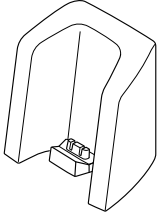
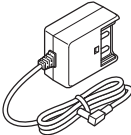

Precautions for installation

- Installing the video door station in the following locations may cause malfunctions.
 - Locations under direct sunlight except for the Video Door Station
 - Locations near heating equipment, such as heaters, boilers, etc.
 - Locations subject to liquid, iron filings, dust, oil, or chemicals.
 - Locations subject to moisture and humidity extremes, such as bathrooms, cellars, greenhouses, etc.
 - Locations where the temperature is quite low, such as inside a refrigerated area or in front of an air conditioner.
 - Locations subject to steam or oil smoke
 - Locations near heating or cooking surfaces
 - Locations close to the sea or directly exposed to sea breeze
- In 50 Hz countries, if a strong fluorescent light enters directly into the camera, it may cause the image to flicker. Either shield the camera from the light or use an inverter fluorescent light.
- If equipment is attached near office automation equipment, televisions, radios, or other similar devices, reception may be affected or noise may occur. Therefore, take care when choosing an installation location.
- Do not use an impact driver to fasten screws. Doing so may cause damage to the device.
- When removing the installed video door station, insulate the wiring, for example, by wrapping with plastic tape.
- If power lines (AC 100 V) are live when exchanging installed video door station, doorbell, or other similar device, consult with the place of purchase and request construction work.
- Due to the nature of the camera built into the video door station, external light and the surrounding environment may affect the projection quality of the TV monitor, so please avoid installing in the following locations.
- Locations where street lights or other lights enter directly into the camera at night

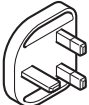

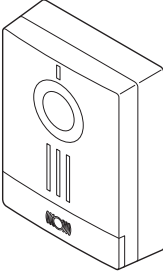
Package Contents

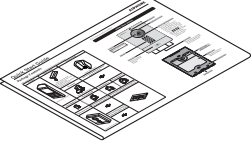
After opening the box, make sure that the following items are included.

Master station	Battery pack	Charging stand	
 Model name: WL-1ME.En	 Model name: WLW-BT.E *Do not peel off the vinyl cover of the battery pack. *Ne retirez pas le couvercle en vinyle de la batterie.	 Model name: WLW-C.E	
	AC adapter	Wall mounting wood screws for charging stand x2	
	 Model name: BLJ06W050040P2-U		
Plug adapter A	Plug adapter BF	Plug adapter C	Plug adapter O
			
<p>* Use the appropriate plug in your region to the AC adapter.</p>			
Video door station	Wall mounting wood screws for video door station x2		Quick Start Guide
 Model name: WL-DA.En			
	Wall mounting screws for video door station x2 (2)		Handling Precautions Manual
			

n: Destination No.

Part Names and Function

Master station

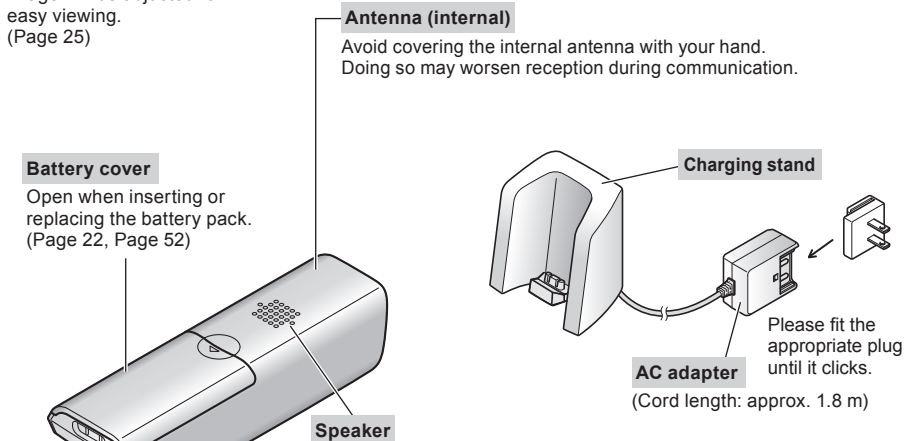
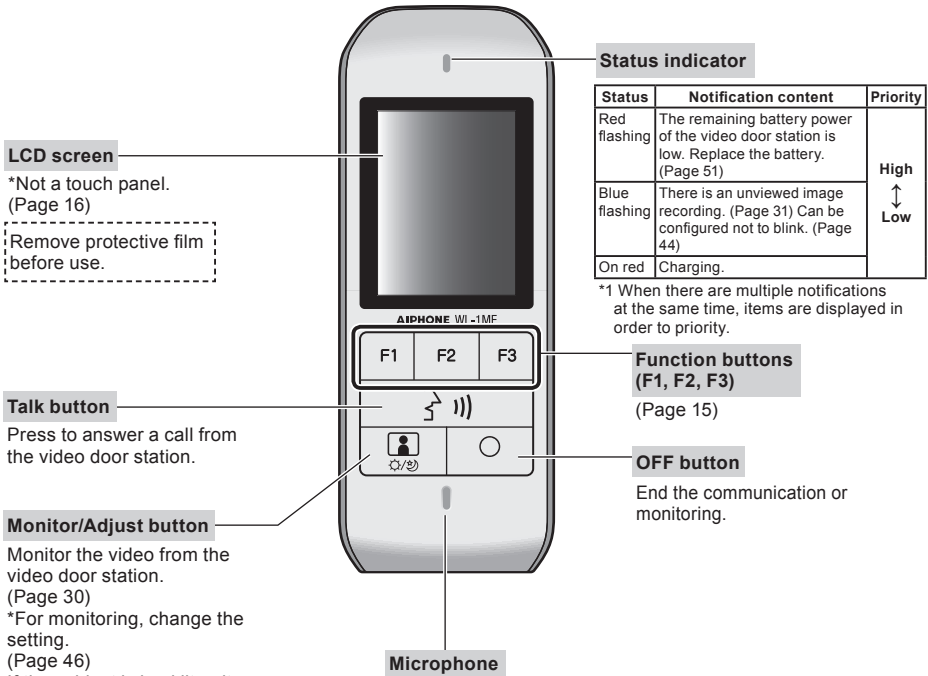

The master station ringtone and the voice of the other person can be heard from here.

⚠ Caution

- Loud sounds can occur suddenly, so keep this section away from your ear.

Using the function buttons (F1, F2, F3)

Functions manipulated by the function buttons (F1, F2, F3) are displayed on the screen when available.

* The functions displayed on the screen change in accordance with the status of this device.

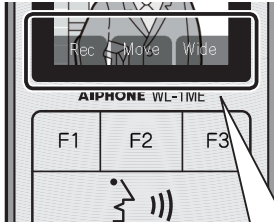

The functions displayed on the screen can be manipulated by the function button just below.

Example: During standby

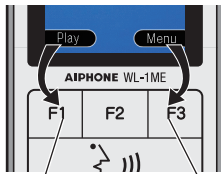

Display recorded images stored on the master station.

Display the menu screen.

Example: When receiving a call

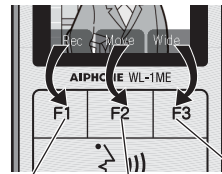

Record the displayed image to the master station.

Change the display position of the screen.

Change the screen to widescreen.

Part Names and Function

Screen

How to read screen

The following are screen examples. The actual display may differ.

Standby screen

- Standby screen will be brighter when the master station is picked up from the charging stand.
- The screen will return to the standby screen when the master station is placed on the charging stand during communication or operation.
- The screen will be darker after certain time.
If the master station is not on the charging stand and more time passes, the screen will be turned off.
- If any button is pressed while the screen is off, the standby screen will be displayed.

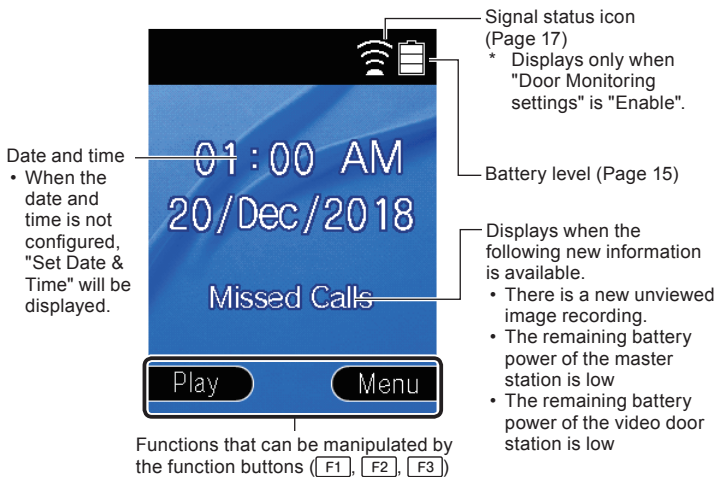

Viewing images

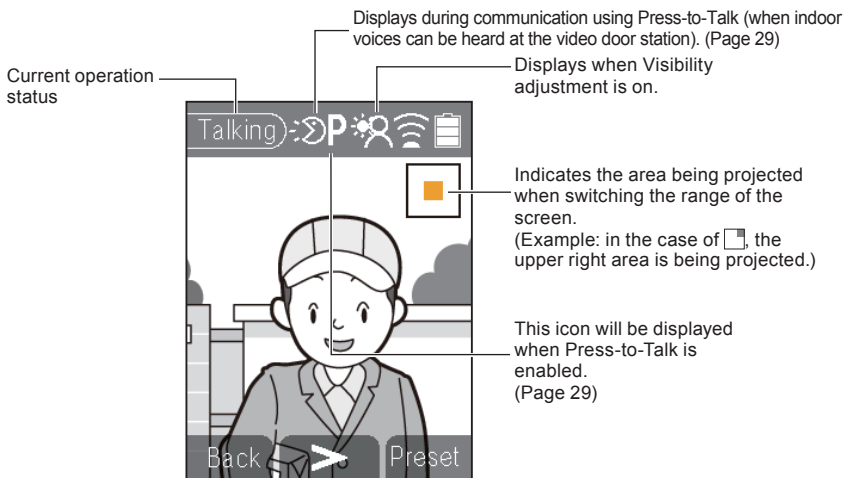

Reading the battery level of the master station

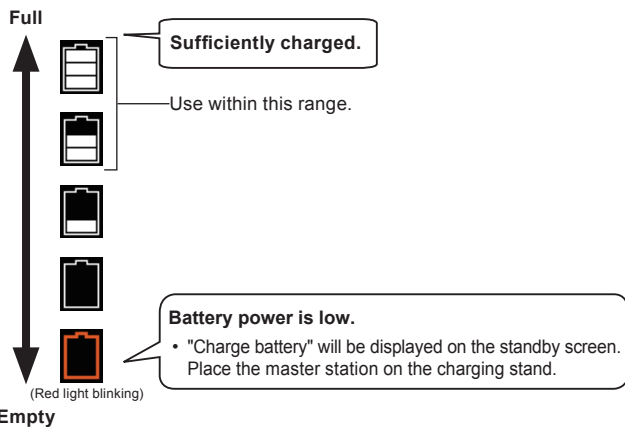

Reference for usage time after fully charged (after 16 hours of charging from running out of charge)

(When the operation temperature is 20°C)

- Total communication time (total communication time with video door station when repeating call and talk): approx. 4 hours
- Standby time (time that be able to receive a call within the radio wave range without placing on the charging stand): approx. 18 hours

*When not being used and charged.

*Usage time will be shorter when the signal strength is "Out of range".

Reading the signal status icon

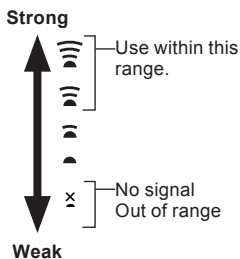

Notes

- The signal strength display is updated with a delay of a few seconds.

Request

- When signal strength is weak, move to a location with strong signal strength.

Part Names and Function

Video door station

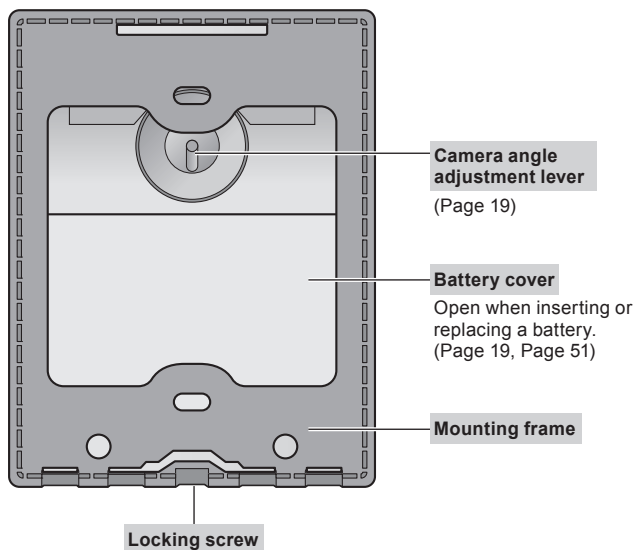
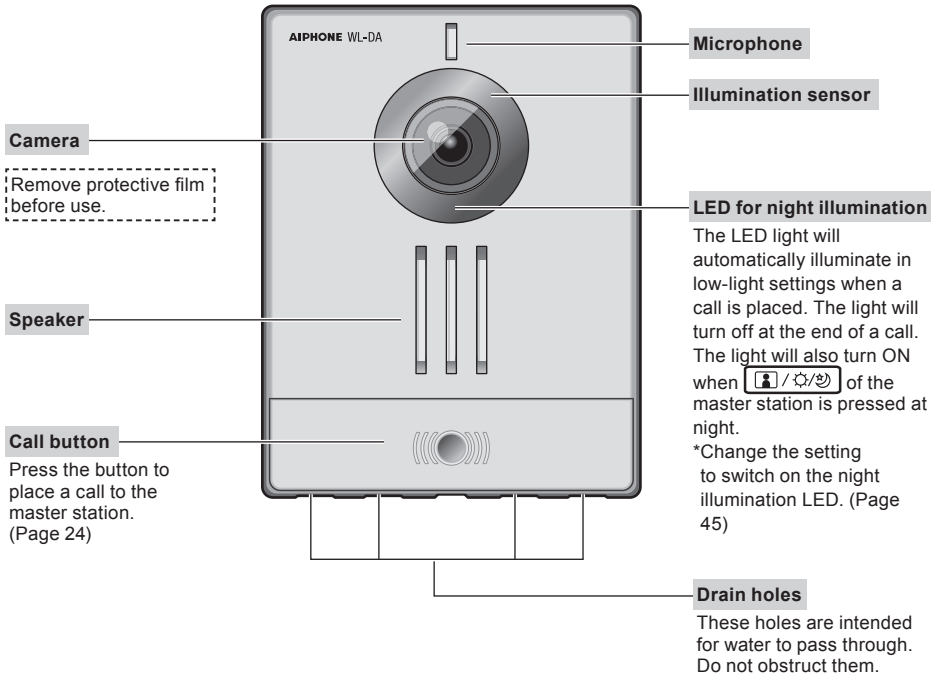

Installing the video door station

1 Remove the mounting frame from the video door station

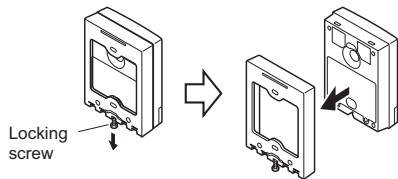

Loosen the locking screw on the bottom and remove the frame.

2 Remove the battery cover

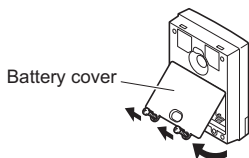

Loosen the two screws and remove the battery cover.

3 Insert six AA batteries (batteries not included)

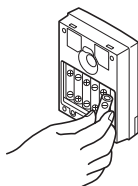

Align the plus (+) and minus (-) terminals correctly.

4 Attach the battery cover

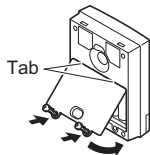

- Set the hooks of the upper section of the battery cover and attach the battery cover.
- Tighten the two screws.
- There is rubber packing attached to the rear side of the battery cover. Make sure that the rubber packing is not removed during attachment.

5 Adjust the camera angle

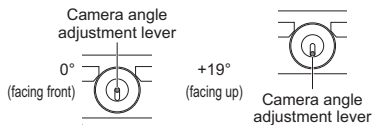

The camera angle can be adjusted from 0° through 19°.

6 Attach the mounting frame to a wall

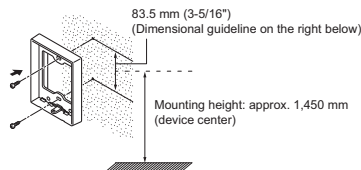

Secure the stand using the two included screws or wooden screws.

*Refer to "Camera range and mounting position". (Page 20)

7 Attach the video door station to the mounting frame

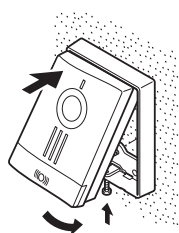

Insert the top section of the video door station into the mounting frame and push in the bottom section. Tighten the locking screw on the bottom to secure the video door station.

Notes

- Do not use wood screws when attaching to a switchbox.
- Mounting may not be possible depending on the wall surface.

Reference for attachment hole width

83.5 mm

Installing the video door station

Camera range and mounting position

◇ Projection range at 500 mm in front of camera

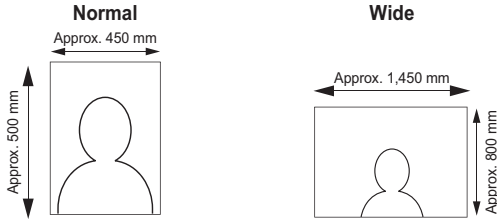

◇ Normal

Vertical

Camera angle:0°

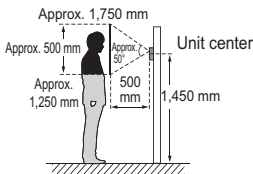

Camera angle:19°

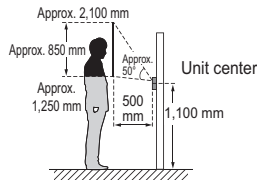

*The screen format can be switched. (Page 24)

Horizontal

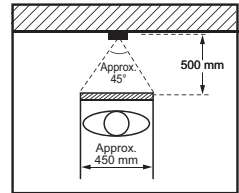

◇ Wide

Vertical

Camera angle:0°

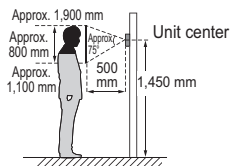

Camera angle:19°

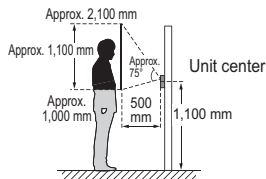

Horizontal

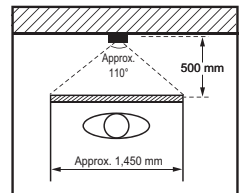

- We recommend installing lighting to further improve projection at night. Try to prevent strong lighting from entering the camera directly.

Gate light

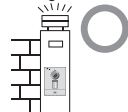

Entrance light



Installing the charging stand

Connecting the power adapter to the charging stand

1 Connect the power adapter to connector terminal on the rear side of the charging stand

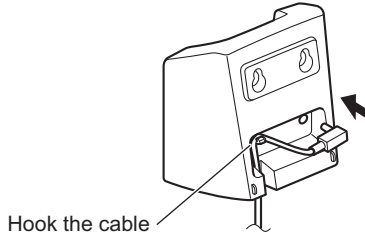

Notes

- Set the master station on the charging stand when it is not in use.
- Use the charging stand after placing it on a table or hanging it on a wall.
- Do not install the charging stand on a tilted surface. Otherwise, it may not be able to charge correctly.

When hanging the charging stand on a wall

⚠ Caution

- **When hanging the charging stand on the wall, attach it securely to avoid to fall.**
Falls may cause damage or injuries.
*Avoid weak wall surfaces, such as drywall, autoclaved lightweight concrete (ALC), concrete blocks, and plywood with a thickness of 18 mm or less.
- **When the charging stand has been hung on a wall, do not place heavy objects on the charging stand or lean on the charging stand.**
This may cause damage or injuries.

1 Attach the included wood screws x2 to a wall or pillar, and then hang the holes of the charging stand on the wood screws to secure it.

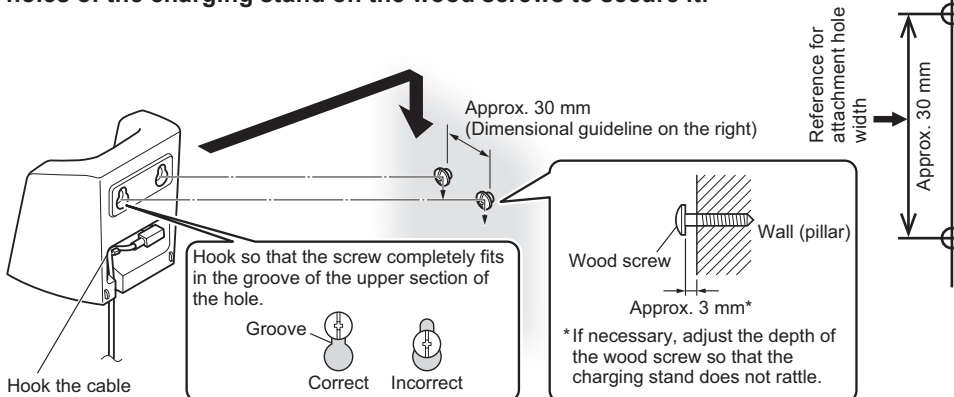

Charging the master station

Charge the master station for 16 hours before using it for the first time.

1 Open the battery cover

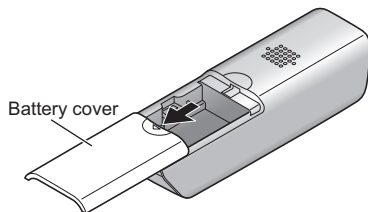

2 Connect the connector of the battery pack to the connector terminal inside the battery cover

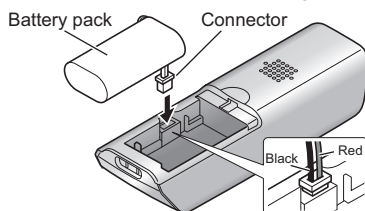

3 Set the battery pack and close the battery cover

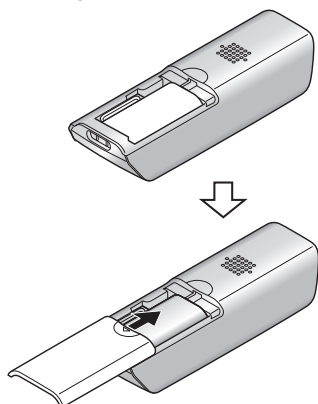

- Do not trap the connector of the battery pack.

4 Place the master station on the charging stand

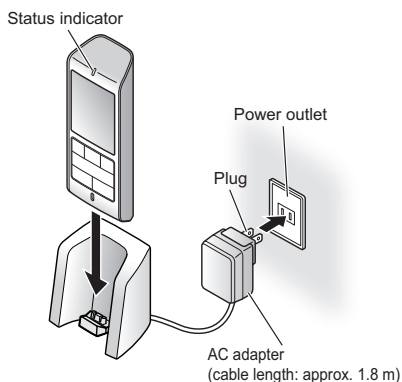

Use the appropriate plug in your region to the AC adapter.

- The status indicator switches on red during charging.
- After sufficient charging, the status indicator will be off.

Notes

- Charging time increases in the following conditions.
 - The operation temperature is low.
 - The AC power voltage is low.
 - The master station was used during charging
 - The reception status of this unit is "Out of range"
- **Set the master station on the charging stand when it is not in use. Overcharging does not occur even when the master station is always on the stand.**
- The status indicator may not switch off immediately when this unit is removed from the charging stand.
- The remaining battery power displayed just after the battery pack is installed may be lower than the actual value.
- "ALPHONE" is displayed on the screen after the master station is switched on, and the status indicator switches on red.

Warning

- Do not peel off the vinyl cover of the battery pack.
- If this unit will be removed from the charging stand or the power adapter will be unplugged for one week or more, remove the connector and remove the battery pack. (This maintains the battery pack performance and prevents consumption of the battery pack.)

Setting the Date and Time

Set the date and time before using it for the first time. This date and time is used for the listed dates and times of recordings.

Notes

- The date and time may revert back to the default setting when, for example, the battery pack is removed, etc. In such cases, set the date and time again.
- Clock accuracy may deviate as much as ± 1 minute per month. We recommend configuring the date and time periodically.

1 Press **F3** (Menu) on the standby screen

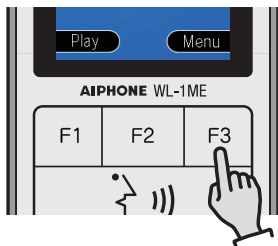

The menu screen will be shown.

2 Select "Date & Time" using **F2** (V) and press **F3** (Select)

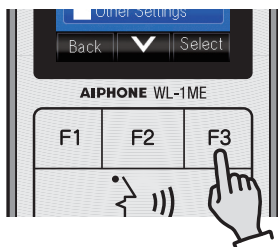

3 Configure the current date and time using **F1** (Λ) or **F2** (V) and press **F3** (Select)

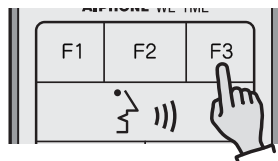

- The item to be configured flashes in yellow.
- How to change the date and time
 - F1** (Λ): Increases the value by 1.
 - F2** (V): Decreases the value by 1.
- If **F1** is pressed when the maximum value is displayed, the value returns to the minimum value.

4 Repeat Step 3 and configure the month, year, hour, and minute

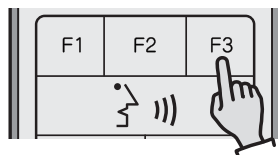

A "beep" is heard when the configuration is finished.

Receiving a call

Answering a door call and communicating

When the call button of the video door station is pressed



1 View a visitor by looking at the screen

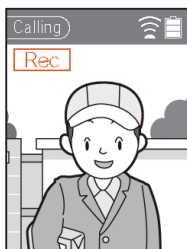

- When the screen is difficult to see due to backlighting, adjust the screen brightness. (Page 25)

2 Press , and speak with other party

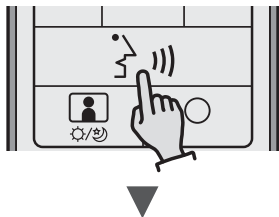

Communicate with the other party after "Talking" is displayed.

- Speak with the other party in turns. If both parties speak simultaneously, voices may be cut off.
- If the voice of the other party cannot be heard well, adjust the volume. (Page 40)
- When approx. 50 seconds passes from the start of communication, "Extend" will be displayed. It is not possible to switch the screen (Page 26) or record images manually (Page 28) during this time.

Extending the talk time

After "Extend" is displayed the screen, press  (Extend)

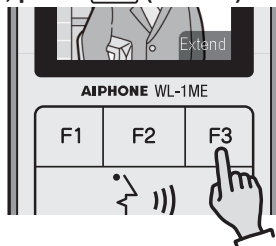

Communication will be extended approx. one minute.

3 When the communication ends, press

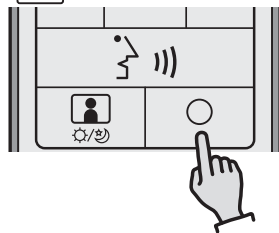

Notes

- When there is no response after the master station ringtone starts, the call will be ended after approx. 30 seconds. The screen will return to the standby screen.
- Communication time is approx. 1 minute. Communication can be extended twice.
- When the ambient noise is loud enough to interrupt the audio, communicate using push-to-talk. (Page 29)
- When a call is received from the video door station, image recording will start automatically. During recording, "Rec" (Recording video) is displayed on the screen.
- The night illumination LED of the video door station can be switched on at night. (Page 45)
- It takes approx. six seconds from when the call button of the video door station is pressed until images are displayed.
- When the master station is placed on the charging stand during communication, the screen will return to the standby screen.

Operations during placing a call and communication

Adjust video to enhance visibility (visibility correction)

This function is used when the face of a visitor projected on the screen is difficult to see due to backlighting.

This function can be used during placing a call, communication, and monitoring from the video door station.

Setting backlight correction

1 Press  when an image is projected on the screen

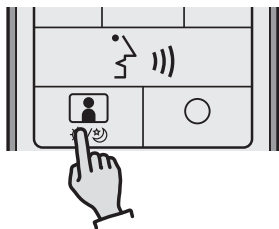

The visibility correction icon  will be displayed, and the image will be adjusted automatically.

Stopping correction

1 Press  again

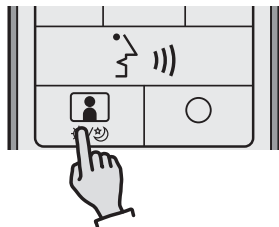

The visibility correction icon will be disappeared, and the screen returns to the state before correction.

Notes

- Depending on the brightness of the background projected by the camera, the image may not change even after  has been pressed.

Correction effects

Darker areas become brighter.



Switching the screen format

Switching video screen format of the video door station between normal and wide

You can switch the video of the video door station between "Normal" and "Wide".

Notes

- Manual image recording is not possible during widescreen display. (Page 28)

1 When the video of the video door station is displayed on the screen, press **[F3]** (Wide)

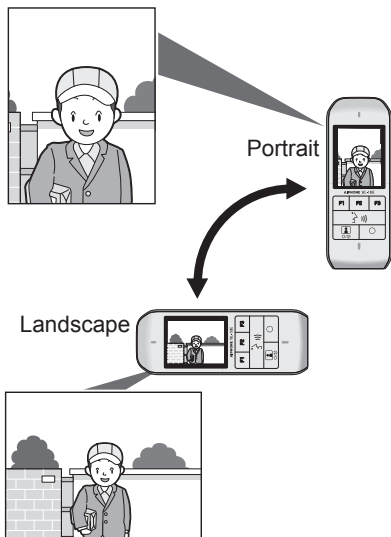
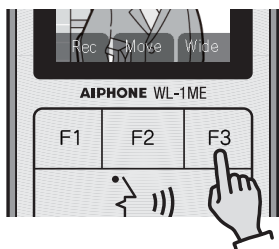

If **[F3]** (Normal) is pressed, the screen will return to normal screen.

Changing the display position of the screen

The display position of the normal screen can be switched and changed.

1 Press **F2** (Move) when an image from the video door station is displayed on the screen

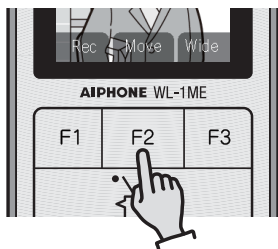

2 Press **F2** (>)

The screen moves as shown below.
The normal screen moves within the capture range of the widescreen.
The icon  at the top right of the screen indicates the currently displayed location.

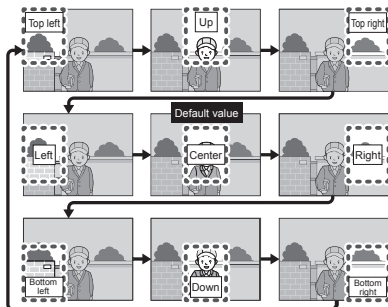

To end moving, press **F1** (Back).

Changing a moved display position to the initial display position

1 Press **F3** (Preset)

“Preset complete” will be displayed, and the initial display position will be changed.

- If the position will not be changed, press **F1** (Back).

Operations during placing a call and communication

Recording video of the video door station

When a call is received from the video door station, recording starts automatically. (Automatic image recording)

If necessary, recording is possible after the automatic image recording. (Manual image recording)

Notes

- Recorded images are stored in the memory of the master station.
- The master station can record only images. It cannot record audio.
- Up to 100 recordings can be saved for automatic and manual image recording. If this number is exceeded, recordings will be overwritten from the oldest recording.

Automatic image recording

When a call is received from the video door station, automatic image recording will be performed.

Three images will be recorded by as one recording.



During recording, **Rec** (Recording video) is displayed.

Notes

- Automatic image recording will start approx. six seconds after the call button of the video door station is pressed.
- When a call is received from the video door station, following action will be taken.

Press the call button of the video door station

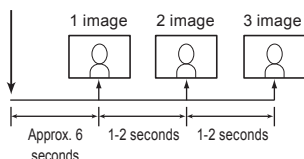

Up to three images can be recorded.

Manual image recording

Screen video can be recorded during placing a call, communication, and monitoring from the video door station. One image is recorded by one recording action.

1 Press **F1** (record)

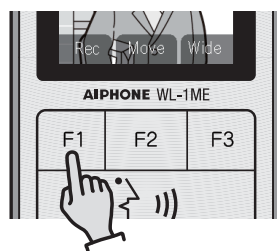

Notes

- Manual image recording is not possible during automatic image recording.

When the ambient noise is too loud to talk (Press-to-Talk)

This unit prioritizes the loud side and switches automatically so the quiet side can be heard. Press-to-talk is useful when the ambient noise is loud enough to interrupt audio.



- 1** Press and hold  for two seconds or longer during communication

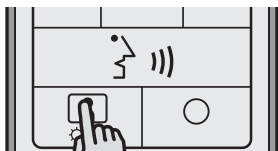

A "be-beep" sound is heard, and "P" will be displayed.

When listening

- 2** Release  "Talk"



 will disappear from the top of the screen.
* The other party cannot hear your voice.

Notes

- During press-to-talk communication, the other person can hear your voice only when  is being pressed.
- Press-to-talk cannot be off until communication is ended.

When talking

- 2** Continue pressing  "Talk" while talking



 will be displayed at the top section of the screen.

* The other party's voice cannot be heard while the button is pressed.

View outside

View (monitor) the entrance

Video door station video and audio can be monitored.



Notes

- This function can be used only when "Door Monitoring settings" is "Enable". (Page 46)

- 1 Press  on the standby screen.

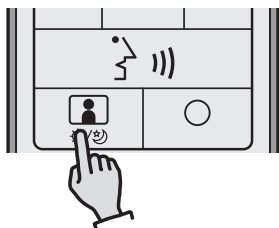

After about nine seconds, a view of the entrance will be displayed on the screen, and audio can be heard.

* Sounds inside cannot be heard outside.



When talk to the other party

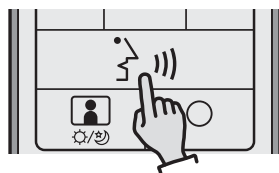

Press 

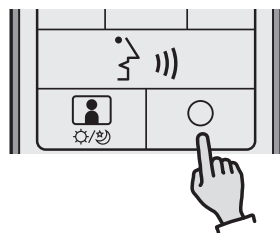

- 2 Press  to end monitoring



Notes

- The following operations can be performed during monitoring.
 - Visibility correction (Page 25)
 - Switching the screen format (Page 26)
 - Manual image recording (Page 28)
- Even when  "End" is not pressed, monitoring will be ended automatically after approx. one minute.
- When a call is received from the video door station during monitoring, automatic image recording will start approx. two seconds after the call button of the video door station is pressed. When  is pressed, communication starts.

Playing recordings

Playing recordings

To play recorded images, first display the playback queue screen.
Check recording.

Notes

- When there are newly recorded unviewed images, the status indicator flashes in blue, and "Missed Calls" will be displayed on the standby screen.
- Even with unviewed recordings remaining, if the playback queue is displayed, the unviewed recordings status indicator will turn off.
- At the playback queue screen, items are displayed in order starting from the newest.
- If there is no operation approx. one minute, the standby screen returns.

Displaying the playback queue screen

- 1 At the standby screen, press **F1 (Play)**

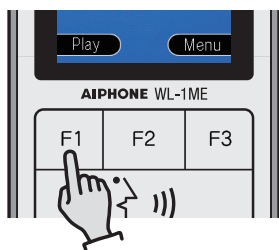

[Example: playback queue screen]

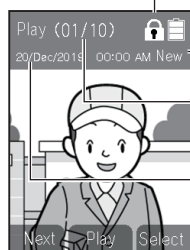

Displayed when the recording is locked.

Displayed when the recording is not viewed.

Number of recording currently displayed / total number of recordings

Recording date and time

*Will not be displayed if the date and time are not configured.

Playing the recordings

- 1 At the playback queue screen, press **F1 (Next)**

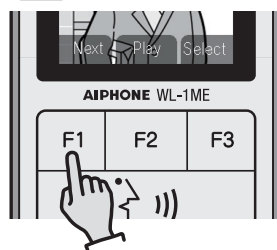

The first image of the previous record will be displayed. When displaying the oldest record and pressing, the display will return to the latest recording.

Playing recordings

- 2** When the recording is displayed on the screen, press **F2** (Play)

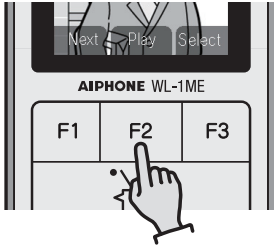

Images of the selected recording will be displayed in order from the first image.

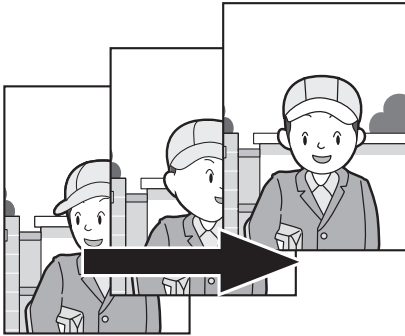

* In the case of a manual recording, only one image will be displayed.

- 3** Press **⏏** to end playback

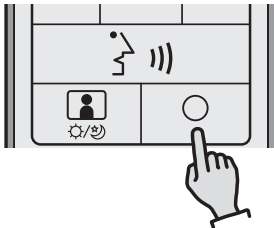

Lock recordings

Recordings can be locked from being deleted.

Notes

- Locked recordings will not be overwritten by new recording images.
- Up to 20 recordings can be locked.
- When 20 items are locked, "Lock" will not be displayed on the screen. To lock another recording, remove the lock of recordings.

Lock recordings

1 Display the recording to be locked (Page 31)

2 Press **F3** (Select)

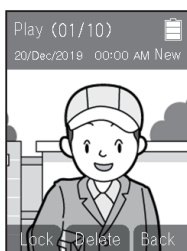
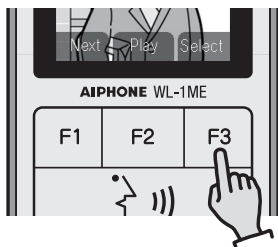

The Lock/Delete selection screen will be displayed.

3 Press **F1** (Lock)

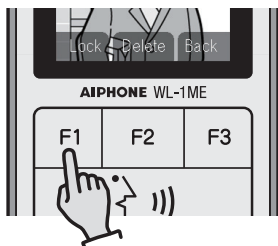

A "beep" sound will be heard, and "Image has been locked" will be displayed. The record will be locked. The icon  will be displayed at the top section of the playback queue screen.

Unlock recordings

1 Display the recording to unlock (Page 31)

2 Press **F3** (Select)

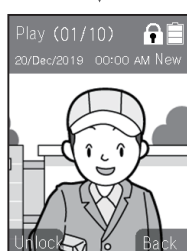
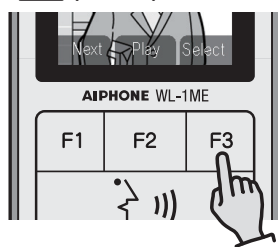

The Unlock selection screen will be displayed.

3 Press **F1** (Unlock)

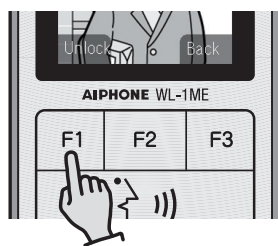

A "beep" sound will be heard, and "Image has been unlocked" will be displayed. The lock will be canceled. The icon  will be disappeared from the top of the playback queue screen.

Playing recordings

Deleting recordings

There are two methods to delete recordings: delete a single selected item or delete all recordings.

Deleting a single recording

Notes

- Protected recordings cannot be deleted. Cancel protection and delete the recording.

1 Display the recording to be deleted (Page 31)

2 Press **F3** (Select)

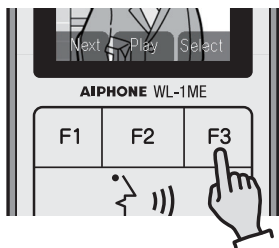

The Lock/Delete selection screen will be displayed.

3 Press **F2** (Delete)

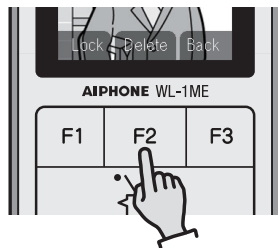

A confirmation message will be displayed..

4 Press **F1** (Yes)

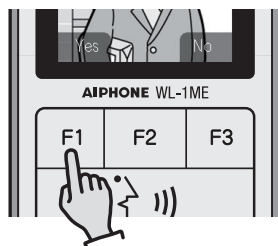

A "beep" sound will be heard, and the recording will be deleted.

Deleting all recordings

Notice

- Deleting all recordings also deletes protected recordings.

1 Press **F3 (Menu)** on the standby screen

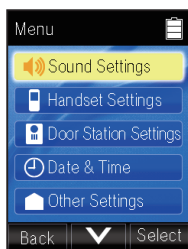
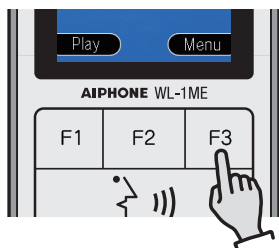

The menu screen will be displayed.

2 Select "Other Settings" using **F2 (V)** and press **F3 (Select)**

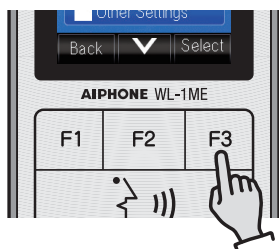

The Other Settings screen will be displayed.

3 Select "Delete All Recorded Images" using **F2 (V)** and press **F3 (Select)**

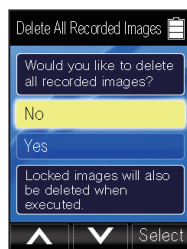
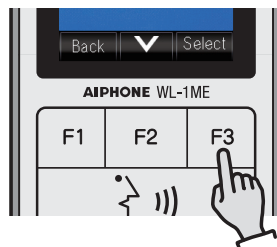

A confirmation message will be displayed.

4 To continue, select "Yes" using **F1 (Λ)** or **F2 (V)** and press **F3 (Select)**

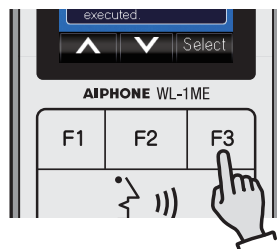

A "beep" sound will be heard, and "Deleted" will be displayed. All the recordings will be deleted and return to the Other Settings screen.

* To return to the previous screen, select "No" using **F1 (Λ)** or **F2 (V)** and press **F3 (Select)**.

Setting personal preferences

Setting and adjustment list

The settings of each function of the master station can be changed or adjusted in accordance with use.

Notes

- If there is no operation for approx. one minute during configuration, configuration will be canceled, and the standby screen returns.
- If a call is received during configuration, configuration will be canceled, and the calling screen will be displayed.

Function		Details	Method Page
Sound Settings	Master Station Ringtone Volume	Set the volume of the master station ringtone	37
	Master Station Ringtone	Set the ringtone of the master station	38
	Master Station Speaker Volume	Set the speaker volume of the master station during communication	43
	Video Door Station Speaker Volume	Set the speaker volume of the video door station during communication	41
	Master Station Button Feedback	Enable tone when a button is pressed.	42
Master Station Settings	Screen Brightness	Set the brightness of the screen	43
	Missed Call LED	Set Enable/Disable the status indicator for missed calls	44
Video Door Station Settings	Night Illumination LED	Set whether to switch on the illumination of the video door station at night during calls/communication or monitoring individually	45
	Door Monitoring	Set whether to use the door monitoring function	46
Date & Time		Set the Date and Time	23
Other Settings	Check Video Door Station Battery	Display the remaining battery level of the video door station	50
	Delete All Recorded Images	Delete all recordings saved to the master station (Protected recordings will be deleted)	35
	Initialize	Reset all the settings to default.	48
	Display Mode	Set the display mode	49

Sound settings

Adjusting the master station ringtone volume

Adjust the master station ringtone volume from 0 through 5.

The default setting is "3".

- 1 Press **F3 (Menu)** on the standby screen

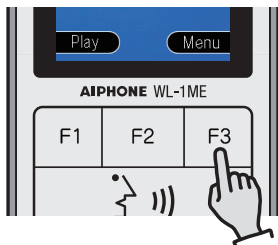

The menu screen will be displayed.

- 2 Select "Sound Settings" using **F2 (V)** and press **F3 (Select)**



The Sound Settings screen will be displayed.

- 3 Select "Handset Station Ringtone Volume" using **F2 (V)** and press **F3 (Select)**

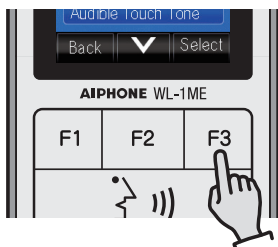

The Master Station Ringtone Volume settings screen will be displayed.

- 4 Press **F1 (<)** or **F2 (>)** to change the volume

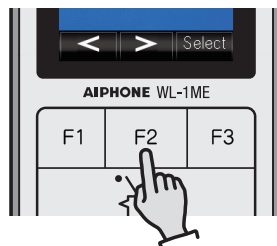

The master station ringtone will be played at the selected volume.

- 5 After configuration, press **F3 (Select)**

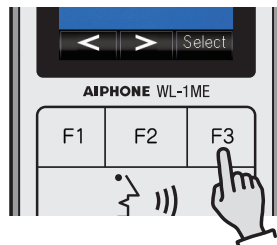

A "beep" sound will be heard when the configuration is finished.

Setting personal preferences

Adjusting the ringtone of the master station

Choose a combination from the 4 instruments and 4 melodies for the ringtone of the master station.

Instrument	Melody
♪Piano	1 to 4
♪Vibraphone	1 to 4
♪Harp	1 to 4
♪Marimba	1 to 4

The default setting is "♪Piano 1".

1 Press **F3 (Menu)** on the standby screen

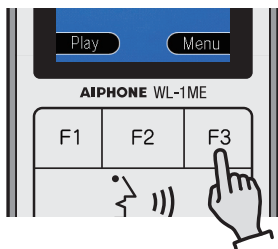

The menu screen will be displayed.

2 Select "Sound Settings" using **F2 (V)** and press **F3 (Select)**

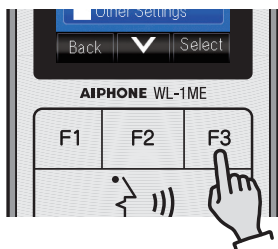

The Sound Settings screen will be displayed.

3 Using **F2 (V)**, select "Handset Ringtone", and then press **F3 (Select)**

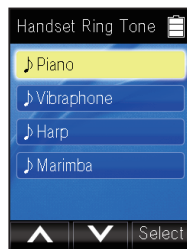
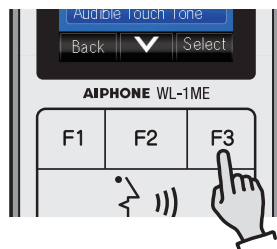

The Master Station Ringtone settings screen will be displayed.

4 Select the instrument using **F2 (V)** and press **F3 (Select)**

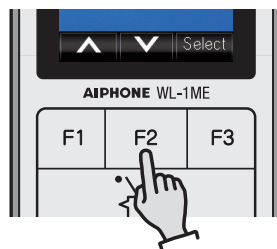

The melody selection screen will be displayed.

- 5** Select the melody using **F1** (Λ) or **F2** (V)

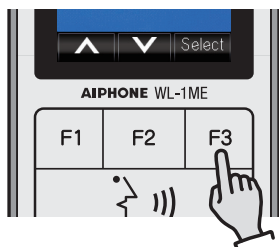

The ringtone of the selected instrument and melody will be configured.

- 6** After selection, press **F3** (Select)

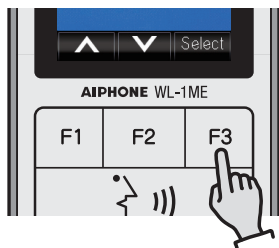

A "beep" sound will be heard when the configuration is finished.

Setting personal preferences

Adjusting the master station speaker volume

Adjust the master station speaker volume during communication from 1 through 5. The default setting is "3".

- 1 Press **F3 (Menu)** on the standby screen

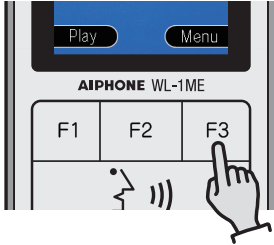

The menu screen will be displayed.

- 2 Select **"Sound Settings"** using **F2 (V)** and press **F3 (Select)**



The Sound Settings screen will be appeared.

- 3 Using **F2 (V)**, select **"Handset Speaker Volume"**, and then press **F3 (Select)**

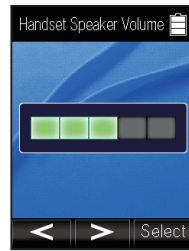
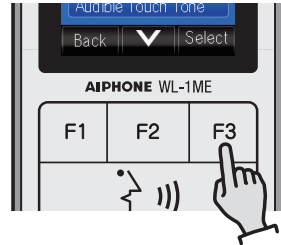

The Master Station Speaker Volume settings screen will be displayed.

- 4 Press **F1 (<)** or **F2 (>)** to change the volume

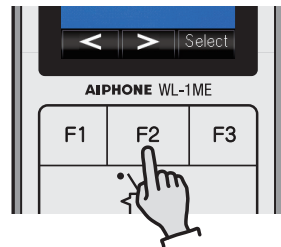

- 5 After adjustment, press **F3 (Select)**

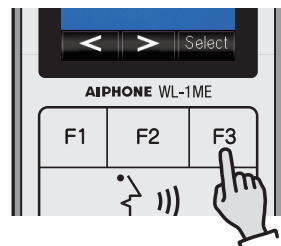

A "beep" sound will be heard when the configuration is finished.

Adjusting the video door station speaker volume

Adjust the video door station speaker volume during communication from 1 through 5. The default setting is "3".

1 Press **F3** (Menu) on the standby screen

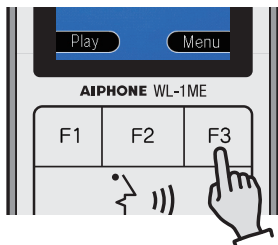

The menu screen will be displayed.

2 Select "Sound Settings" using **F2** (V) and press **F3** (Select)

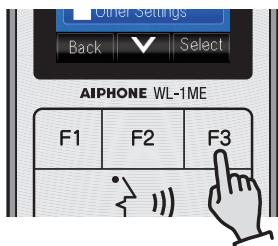

The Sound Settings screen will be displayed.

3 Select "Door Station Speaker Volume" using **F2** (V) and press **F3** (Select)

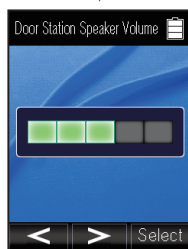
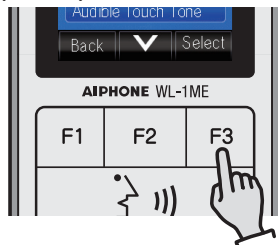

The Video Door Station Speaker Volume settings screen will be displayed.

4 Press **F1** (<) or **F2** (>) to change the volume

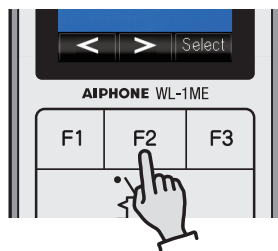

5 After adjustment, press **F3** (Select)

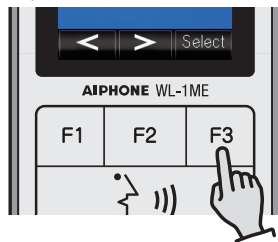

A "beep" sound will be heard when the configuration is finished.

Setting personal preferences

Enable/Disable the tone when a button is pressed

Configure whether to generate a master station button feedback tone when a button is pressed.

The default setting is "Enable".

1 Press **F3** (Menu) on the standby screen

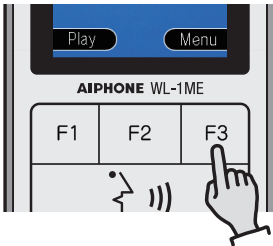

The menu screen will be displayed.

2 Select "Sound Settings" using **F2** (V) and press **F3** (Select)

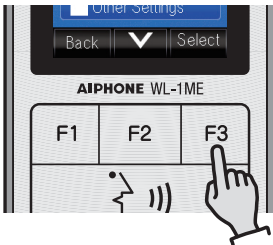

The Sound Settings screen will be displayed.

3 Select "Handset Button Feedback" using **F2** (V) and press **F3** (Select)

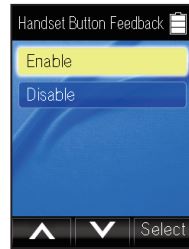
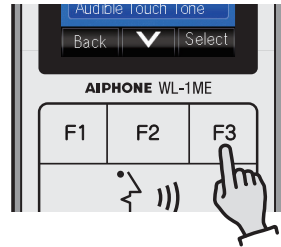

The Master Station Button Feedback settings screen will be displayed.

4 Select "Enable" or "Disable" using **F1** (A) or **F2** (V)

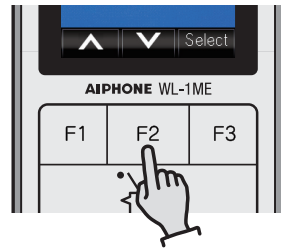

5 After selection, press **F3** (Select)

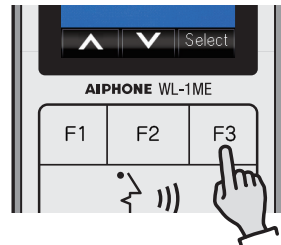

A "beep" sound will be heard when the configuration is finished.

Master station settings

Adjusting the brightness of the screen

Adjust the brightness from 1 through 5.
The default setting is "3".

- 1 Press **F3** (Menu) on the standby screen

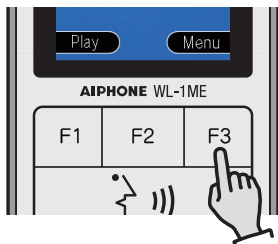

The menu screen will be displayed.

- 2 Select "Handset Settings" using **F2** (V) and press **F3** (Select)

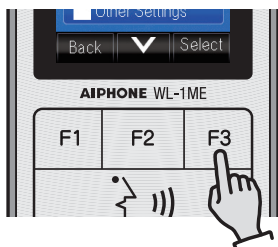

The Master Station Settings screen appears.

- 3 Select "Screen Brightness" using **F2** (V) and press **F3** (Select)

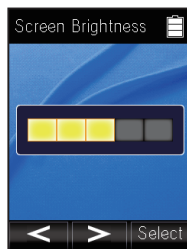
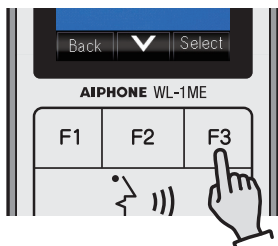

The Screen Brightness settings screen will be displayed.

- 4 Press **F1** (<) or **F2** (>) to change the brightness

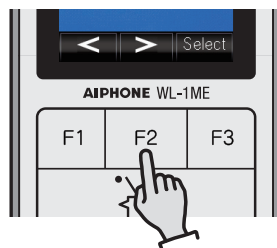

- 5 After adjustment, press **F3** (Select)

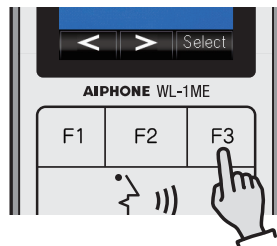

A "beep" sound will be heard when the configuration is finished.

Setting personal preferences

Set Enable/Disable for the status indicator for missed calls

Configure whether to make the status indicator flash in blue when there is a unviewed image. The default setting is "Enable".

Notes

- The status indicator turns on or flashes in red when there is a notification of "Charging" or "Replace door station battery" even Missed Call LED has been set to "Disable".

1 Press **F3 (Menu)** on the standby screen

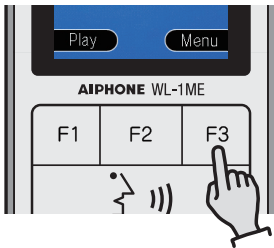

The menu screen will be displayed.

2 Select "Handset Settings" using **F2 (V)** and press **F3 (Select)**

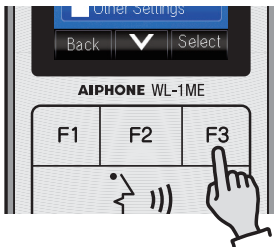

The Master Station Settings screen will be displayed.

3 Select "Missed Call LED" using **F2 (V)** and press **F3 (Select)**

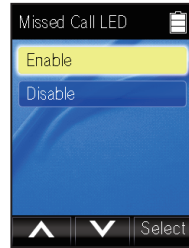
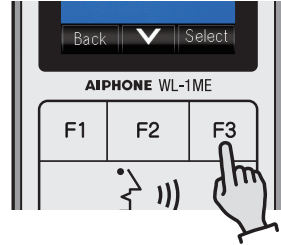

The Missed Call LED settings screen will be displayed.

4 Select "Enable" or "Disable" using **F1 (A)** or **F2 (V)**

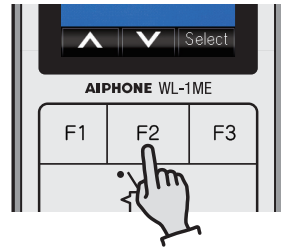

5 After selection, press **F3 (Select)**

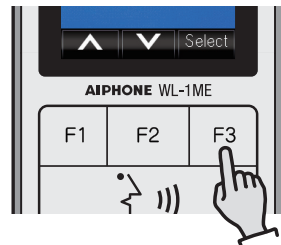

A "beep" sound will be heard when the configuration is finished.

Video door station settings

Set Enable/Disable for the Night Illumination LED

Configure whether to switch on the illumination of the video door station automatically at night individually during calls/communication or monitoring.
The default setting is "Disable".

- 1 Press **F3 (Menu)** on the standby screen

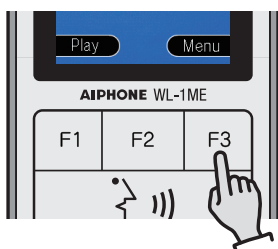

The menu screen will be displayed.

- 2 Select **"Door Station Settings"** using **F2 (V)** and press **F3 (Select)**

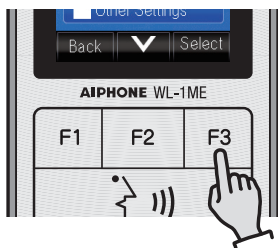

The Video Door Station Settings screen will be displayed.

- 3 Select **"Night Illumination LED"** using **F2 (V)** and press **F3 (Select)**

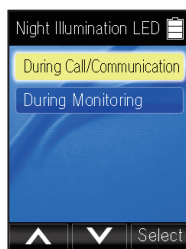
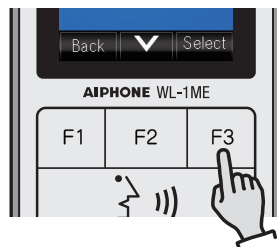

The Night Illumination LED settings screen will be displayed.

- 4 Select **"During Call/Communication"** or **"During Monitoring"** using **F2 (V)** and press **F3 (Select)**

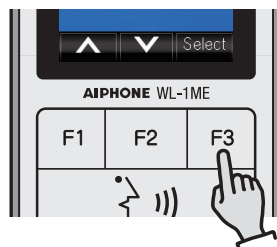

Setting personal preferences

5 Select "Enable" or "Disable" using

F1 (A) or **F2** (V)

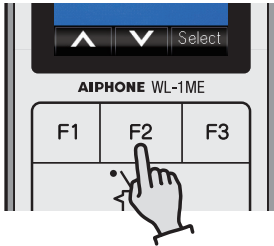

Configuring whether to use the monitoring function

Configure whether to use the monitoring function.

The default setting is "Disable".

Notes

- When "Enable" is configured, the battery power of the video door station is consumed faster.

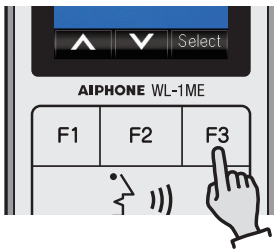
6 After selection, press **F3** (Select)

- A "beep" sound will be heard when the configuration is finished.
- To also configure an item not selected in Step 4 ("During Call/Communication" or "During Monitoring"), repeat Step 4-6.

Notes

- When "During Call/Communication" is "Disable" and "During Monitoring" is "Enable", the night illumination LED does not switch off when calling or communication start during monitoring. The light switches off after calling/communication ends.

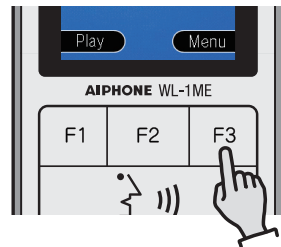
1 Press **F3** (Menu) on the standby screen

The menu screen will be displayed.

2 Select "Door Station Settings" using **F2** (V) and press **F3** (Select)

The Video Door Station Settings screen will be displayed.

3 Select "Door Monitoring" using **F2 (V)** and press **F3 (Select)**

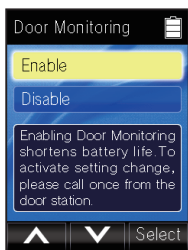
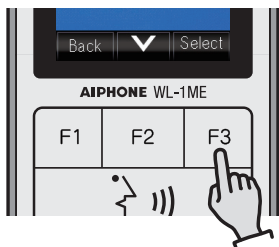

The Door Monitoring settings screen will be displayed.

4 Select "Enable" or "Disable" using **F1 (A)** or **F2 (V)**



5 After selection, press **F3 (Select)**

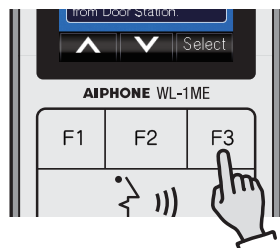

A "beep" sound will be heard when the configuration is finished.

When "Enable" was configured

6 Press the call button of the video door station



The setting will be applied by calling from the video door station.

The signal strength will be displayed on the top of the standby screen after calling/communication has ended.

Setting personal preferences

Other settings

Check Video Door Station Battery level

Check the remaining battery power of the video door station using the master station. Refer to "Checking the remaining battery level of the video door station" (Page 48).

Deleting All Recorded Images

Delete all recorded images stored in the master station memory. Refer to "Deleting all recordings" (Page 35).

Initialize

Initialize settings to return the product to its state at purchase.

Notice

- Initialization will delete all recorded images.

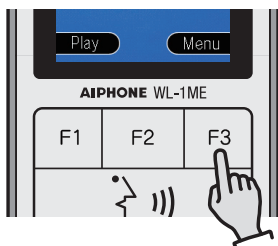
1 Press **F3** (Menu) on the standby screen

The menu screen will be displayed.

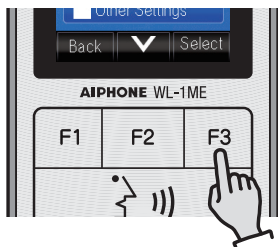
2 Select "Other Settings" using **F2** (V) and press **F3** (Select)

The Other Settings screen will be displayed.

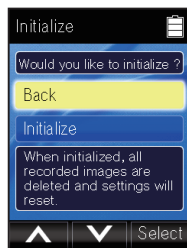
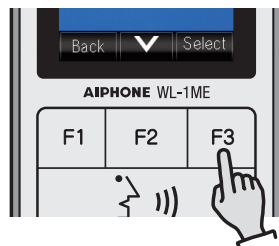
3 Using **F2** (V), select "Initialize", and then press **F3** (Select)

A confirmation message will be displayed.

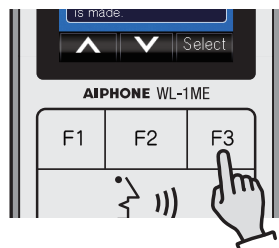
4 To continue press **F1** (Λ) or **F2** (V) to select "Initialize", and press **F3** (Select)

A "beep" sound will be heard and "Initialized" will be displayed. It will return to the screen of Step 2

* To return to the previous screen, select "Back", and then press **F3** (Select).

Setting the display mode

You can configure "Display Mode", which is used for storefront displays or similar cases. In Display Mode, "Demonstration" will be displayed at the top of the screen.

Caution

- Do not use Display Mode in normal operation. In Display Mode, communication between the video door station and master station is not possible.

1 Press **F3** (Menu) on the standby screen

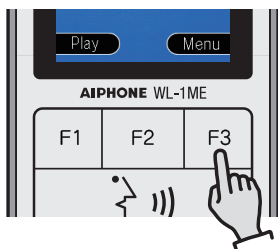

The menu screen will be displayed.

2 Select "Other Settings" using **F2** (V) and press **F3** (Select)

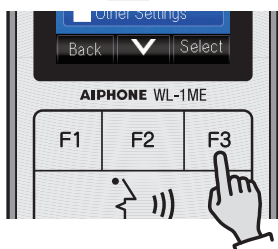

The Other Settings screen will be appeared.

3 Select "Display Mode" using **F2** (V) and press **F3** (Select)

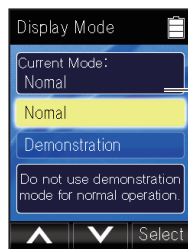
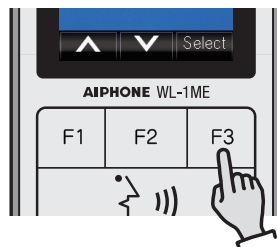

The current mode is displayed.

The Display Mode settings screen will be appeared.

4 Select "Demonstration" and press **F3** (Select)

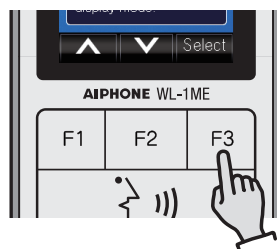

A "beep" sound will be heard and it will enter Demonstration Mode. It will return to the Other Settings screen.

* To return to normal mode, perform Steps **1-3** again, choose "Normal" in Step **4**, and then press **F3** (Select).

Checking the remaining battery level

Checking the remaining battery level of the video door station

Check the remaining battery level of the video door station from the master station.
For the procedure to check the remaining battery level of the master station, refer to "Reading the remaining battery level of the master station" (Page 15).

- 1** Press **[F3]** (Menu) on the standby screen

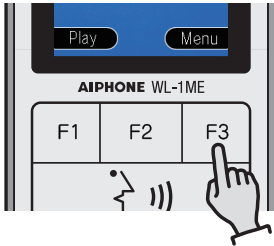

The menu screen will be displayed.

- 2** Select "Other Settings" using **[F2]** (V) and press **[F3]** (Select)

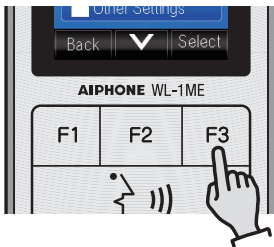

The Other Settings screen will be displayed.

- 3** Select "Check Door Station Battery" using **[F2]** (V) and press **[F3]** (Select)

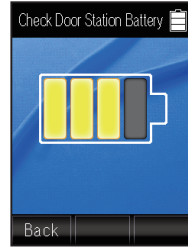
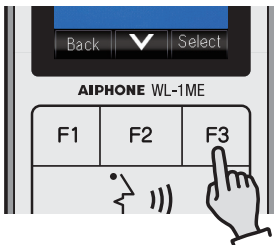

The remaining battery level of the video door station will be displayed.

How to read the remaining battery level of the video door station

Full



Fully charged

The battery lifetime is approx. two years under the following conditions.

- Operation temperature of 20°C, three times a day, and recommended battery (Ni-MH battery with the capacity of 2500 mAh or more)
- When "Door Monitoring settings" is "Disable"

*Differs greatly by usage environment.

*Approx. six months under the above-mentioned conditions when "Door Monitoring settings" is "Enable".



Empty

Low battery power (replace battery)

- During standby, the message "Replace the battery of video door station" will be displayed on the screen of the master station.

Notes

- Depending on the type of battery, the icon  may appear soon after usage.

Replacing batteries

Replacing the battery of the video door station

1 Remove the video door station from the mounting frame

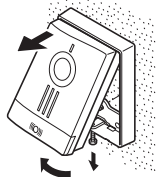

Loosen the locking screw of the bottom section, pull out the bottom section of the video door station first and pull out the top section.

2 Remove the battery cover

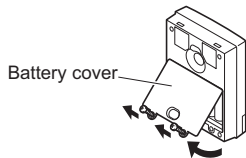

Loosen the two screws and remove the battery cover.

3 Replace with six AA batteries (batteries not included)

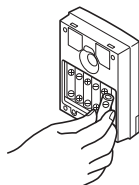

Align the plus (+) and minus (-) terminals correctly.

4 Attach the battery cover

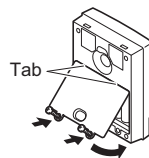

- Set the hooks of the upper section of the battery cover and attach the battery cover.
- Tighten the two screws.
- There is rubber packing attached to the rear side of the battery cover. Make sure that the rubber packing is not removed during attachment.

5 Attach the video door station to the mounting frame

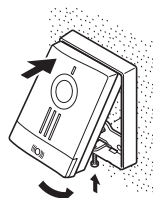

Insert the top section of the video door station into the mounting frame and push in the bottom section. Tighten the locking screw on the bottom to secure the video door station.

Replacing the battery pack of the master station

The battery pack is consumable device. Replace with a new battery pack after the following conditions: even after approx. 16 hours of charging, "Charge battery" is displayed after several minutes of communication, and the remaining battery power reference  flashes in red.

1 Open the battery cover

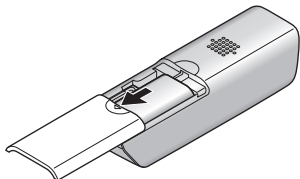

2 Remove the connector of the old battery from the connector terminal and pull out the battery pack

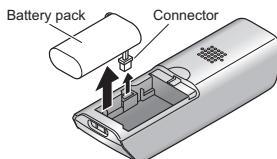

3 Connect the connector of the new battery to the connector terminal, insert the battery pack, and then charge it for approx. 16 hours

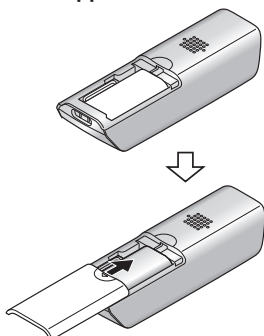

- Avoid to trap the connector of the battery pack.

Caution

- Always use the battery pack intended for the master station (Model name: WLW-BT). If a commercially available battery is used, the master station may not operate normally.

Handling of used battery packs



Ni-MH

Use a Ni-MH battery for the master station battery pack. **A Ni-MH battery uses valuable resources that can be reused.**

To preserve valuable resources, do not dispose of battery packs that are no longer needed. Instead, take them to a rechargeable battery recycling center.

Furthermore, recycling reduces waste and helps protect the environment.

Notes

- Handle used battery packs as described below and bring them to the place of purchase (or a recycling center).
 - Do not disassemble.
 - Do not peel off the exterior cover (covering, tubing, etc.).
 - Do not leave under the sun.

Cleaning

Gently wipe using a soft, dry cloth.

Device surface can easily get scratches. Wipe them gently with a eyeglass cleaner cloth or similar material.

For tough stains, use a lightly damp cloth and neutral detergent diluted in water.

Request

- Do not use thinners, benzene, alcohol, or other chemicals. Furthermore, do not use scrub brushes, sandpaper, or other similar items. Use of such substances will damage or discolor the unit surface.



Charge only mode

The charge only mode is the dedicated mode to charge the battery of the master station. Do not use this mode if it is unnecessary because all functions except the master station's battery charge are disabled with this mode.

<To active this mode>

- Press **F3** (Menu) on the standby screen
- Using **F2** (V), select "Other Setting", and then **F3** (Select)
- Using **F2** (V), select "Display Mode", and then **F3** (Select)
- Using **F2** (V), select "Normal", press and hold TALK button until long beep will sound.
- After long beep, press **○** twice to exit "Menu".

<To disactive>



Disconnect battery pack connector from master station.

Then, connect this connector again.

Troubleshooting

If a problem occurs while operating the system, check the following items.

Problem	Cause	Solution	Reference Page
Screen is black	If the master station is not placed on the charging stand after a certain time, the screen switches off.	Either press any button on the master station or place it on the charging stand.	16
Nothing is displayed even when one of the buttons of the master station is pressed	Has the battery run out?	Charge the battery.	22
	Has the connector of the battery pack been pulled out?	Connect the connector of the battery pack securely.	22
The screen is white or displaying white vertical lines or rings	Sunlight or other strong light may be hitting the camera lens of the video door station. (This does not indicate a malfunction.)	Install the video door station in a location where it is not pointing direct sunlight.	20
The screen is too dark or too bright, and it is difficult to view	The brightness of the room may make it difficult to view the screen.	Adjust the brightness of the screen to make it easier to view.	43
Motion of the subject is blurred at night	At nighttime, a moving subject may be blurry and hard to see because the amount of light on the subject is low.	Adding light may increase the visibility.	20
Video is fuzzy or refreshing is slow (approx. five seconds or longer)	Is your hand covering the (internal) antenna section on the rear surface of the master station?	Remove your hand from the antenna section.	14
	Are the master station and video door station too far or is there a concrete wall or other obstacle between the master station and video door station?	Move the master station and video door station closer to each other or move the master station to a location without any obstacles.	7/8
Cannot place a call. Cannot receive a call. Error sounds when you call.	Are the master station and video door station too far apart or is there a concrete wall or other obstacle between the master station and video door station?	Move the master station and video door station closer to each other or move the master station to a location with no obstacles.	7/8
	Has the battery of the master station run out?	Charge the battery.	22
	Is the remaining battery level of the video door station low?	Check the remaining battery power.	50
There is no master station ringtone when receiving a call from the video door station	Is the master station ringtone volume set to "Off"?	Adjust the master station ringtone volume.	37
	Has the battery of the master station run out?	Charge the battery.	22
Video takes time to be displayed on the master station after the call button of the video door station is pressed	Video will be displayed approx. six seconds after the call button is pressed.	However, this does not indicate a problem.	-

Problem	Cause	Solution	Reference Page
It is difficult to hear the master station ringtone or speaker from the video door station.	Ambient noise may make it difficult to hear.	Adjust the master station ringtone volume, master station speaker volume, and video door station speaker volume as needed.	37 40 41
	Is your hand covering the (internal) antenna section on the rear surface of the master station?	Remove your hand from the antenna section.	12
	Are the master station and video door station too far or is there a concrete wall or other obstacle between the master station and video door station?	Move the master station and video door station closer to each other or move the master station to a location without any obstacles.	7
Communication is interrupted or mostly not possible to be heard.	Are there loud noises around?	Switching to PTT communication makes talking easier.	29
	Is the master station in Demonstration Mode?	Set "Display Mode" of the master station to "Normal".	49
	Is PTT communication on?	During PTT communication, the other person can hear your voice only when  is being pressed.	29
It is not possible to talk even when the  "Talk" button is pressed	The receive volume may be set too low.	Adjust the receive volume.	40
	Are there loud noises on the other party's side?	Switching to PTT communication makes talking easier.	
	The video door station speaker volume may be set too low.	Adjust the video door station speaker volume.	41
The other party cannot hear your voice at all (but can hear the other party's voice)	Is "Video Door Station Settings" - "Door Monitoring Settings" of the master station configured to "Disable"?	Change "Video Door Station Settings" - "Door Monitoring Settings" of the master station to "Enable".	46
	Is the remaining battery level of the video door station low?	Check the remaining battery level.	50
	Are the master station and video door station too far or is there a concrete wall or other obstacle between the master station and video door station?	Move the master station and video door station closer to each other or move the master station to a location without any obstacles.	7
Video of the video door station is not displayed even when  "Monitor" is pressed.	Is "Video Door Station Settings" - "Night Illumination LED" - "During Call/Communication" of the master station configured to "Disable"?	Change "Video Door Station Settings" - "Night Illumination LED" - "During Call/Communication" of the master station to "Enable".	45
	Is "Video Door Station Settings" - "Night Illumination LED" - "During Call/Communication" of the master station configured to "Disable"?		
	The night illumination LED does not switch on automatically even when there is a call from the door at night		

HP: www.aiphone.com

Telephone: 800-692-0200

Mail: tech@aiphone.com

Troubleshooting

Problem	Cause	Solution	Reference Page
The night illumination LED switches on during calling or communication even when "During Call/Communication" is "Disable".	Is "During Monitoring" configured to "Enable"?	When "During Monitoring" is "Enable", the night illumination LED switches on when calling or communication start during monitoring. To disable the night illumination LED during monitoring, configure the "During Monitoring" to "Disable".	45
The battery of the video door station runs out quickly.	Is "Video Door Station Settings" - "Door Monitoring settings" of the master station configured to "Enable"?	To disable the monitoring function, change the setting to "Disable".	46
The status indicator does not switch on even when the unit is placed in the charging stand	Has the power plug been unplugged from the outlet?	Insert the plug securely.	22
	Has the power adapter been removed from the charging stand?	Connect the power adapter securely to the connector terminal on the rear of the charging stand.	
	Has the unit been placed correctly in the charging stand?	Place the unit correctly.	
The status indicator does not switch off even after approx. 16 hours of charging	The charging time increases if the master station is used during charging.	-	22
	Charging time increases when the operation temperature is lower than 20°C or the power voltage is lower than AC 100 V.	-	
The icon  flashes several minutes after communication starts even after charging	The battery pack has reached end-of-life.	To replace the battery pack, please contact Aiphone customer service.	-
When the unit is placed on the charging stand, the screen switches on and off	Has the connector of the battery pack been pulled out?	Connect the connector of the battery pack securely.	-
	Is the battery pack deteriorated?	To replace the battery pack, please contact Aiphone customer service.	

Specifications

Destination		WL-11.E1 US and Canada
Wireless Video Intercom - Master Station		WL-1ME.E1 (FCC ID: 2ALNEWL1MEE1, IC: 4361A-WL1MEE1)
Power source	Build-in Ni-MH battery (AIPHONE WLW-BT.E) 2.4V DC (2000mAh)	
Wireless type	DECT6.0	
Display	2.4 inch TFT color LCD monitor (240 x 320pixels)	
Operation temperature	0 to 40°C (32 to 104°F)	
Dimensions	57(W)x150x(H)x27(D)mm	
RF Transmission Frequency Range	1920 - 1930MHz	
RF Transmission Power	+18dBm (Max)	
Wireless Video Intercom - Charging Stand		WLW-C.E + AC Adapter (BLJ06W050040P2-U)
Power source	100V - 240V AC 50/60Hz	
Power consumption	2.4W (Max)	
Operation temperature	0 to 40°C (32 to 104°F)	
Dimensions	84(W)x88(H)x63(D) mm	
Available AC plug type	A-type (US and Canada)	
Wireless Video Intercom - Video Door Station		WL-DA.E1 (FCC ID: 2ALNEWLDAE1, IC: 4361A-WLDAE1)
Power source	6xAA size batteries (Ni-MH batteries with 2500mAh)	
Operation temperature	-10 to 50°C (14 to 122°F)	
Dimensions	100(W)x130(H)x42(D)mm	
RF Transmission Frequency Range	1920 - 1930MHz	
RF Transmission Power	+18dBm (Max)	

Destination		WL-11.E2 UK, EU, Australia and New Zealand
Wireless Video Intercom - Master Station		WL-1ME.E2
Power source	Build-in Ni-MH battery (AIPHONE WLW-BT.E) 2.4V DC (2000mAh)	
Wireless type	DECT	
Display	2.4 inch TFT color LCD monitor (240 x 320pixels)	
Operation temperature	0 to 40°C (32 to 104°F)	
Dimensions	57(W)x150x(H)x27(D)mm	
RF Transmission Frequency Range	1880 - 1900MHz	
RF Transmission Power	+24dBm (Max)	
Wireless Video Intercom - Charging Stand		WLW-C.E
Power source	AC Adapter (BLJ06W050040P2-U) Input: 100V - 240V AC 50/60Hz Output: 5V DC 400mA	
Operation temperature	0 to 40°C (32 to 104°F)	
Dimensions	84(W)x88(H)x63(D) mm	
Available AC plug type	BF-type (UK), C-type (EU), O-type (Australia and New Zealand)	
Wireless Video Intercom - Video Door Station		WL-DA.E2
Power source	6xAA size batteries (Ni-MH batteries with 2500mAh)	
Operation temperature	-10 to 50°C (14 to 122°F)	
Dimensions	100(W)x130(H)x42(D)mm	
RF Transmission Frequency Range	1880 - 1900MHz	
RF Transmission Power	+24dBm (Max)	

	WL-11.E3
Destination	"Hong Kong, Singapore, Malaysia, Saudi Arabia, UAE Philippines, Indonesia, Turkey, South Africa"
Wireless Video Intercom - Master Station	WL-1ME.E3
Power source	Build-in Ni-MH battery (AIPHONE WLW-BT.E) 2.4V DC (2000mAh)
Wireless type	DECT
Display	2.4 inch TFT color LCD monitor (240 x 320pixels)
Operation temperature	0 to 40 C (32 to 104F)
Dimensions	57(W)x150x(H)x27(D)mm
RF Transmission Frequency Range	1880 - 1900MHz
RF Transmission Power	+24dBm (Max)
Wireless Video Intercom - Charging Stand	WLW-C.E
Power source	AC Adapter (BLJ06W050040P2-U) Input: 100V - 240V AC 50/60Hz Output: 5V DC 400mA
Operation temperature	0 to 40 C (32 to 104F)
Dimensions	84(W)x88(H)x63(D) mm
Available AC plug type	"BF-type (Hong Kong, Singapore, Malaysia, Saudi Arabia, UAE) C-type (Philippines, Indonesia, Turkey, South Africa)"
Wireless Video Intercom - Video Door Station	WL-DA.E3
Power source	6xAA size batteries (Ni-MH batteries with 2500mAh)
Operation temperature	-10 to +50°C (14 to 122°F)
Dimensions	100(W)x130(H)x42(D)mm
RF Transmission Frequency Range	1880 - 1900MHz
RF Transmission Power	+24dBm (Max)

	WL-11.E4
Destination	Vietnam
Wireless Video Intercom - Master Station	WL-1ME.E4
Power source	Build-in Ni-MH battery (AIPHONE WLW-BT.E) 2.4V DC (2000mAh)
Wireless type	DECT
Display	2.4 inch TFT color LCD monitor (240 x 320pixels)
Operation temperature	0 to 40 C (32 to 104F)
Dimensions	57(W)x150x(H)x27(D)mm
RF Transmission Frequency Range	1920-1930MHz
RF Transmission Power	+24dBm (Max)
Wireless Video Intercom - Charging Stand	WLW-C.E
Power source	AC Adapter (BLJ06W050040P2-U) Input: 100V - 240V AC 50/60Hz Output: 5V DC 400mA
Operation temperature	0 to 40 C (32 to 104F)
Dimensions	84(W)x88(H)x63(D) mm
Available AC plug type	C-type
Wireless Video Intercom - Video Door Station	WL-DA.E4
Power source	6xAA size batteries (Ni-MH batteries with 2500mAh)
Operation temperature	-10 to +50 C (14 to 122 F)
Dimensions	100(W)x130(H)x42(D)mm
RF Transmission Frequency Range	1920-1930MHz
RF Transmission Power	+24dBm (Max)

	WL-11.E5
Destination	Mexico
Wireless Video Intercom - Master Station	WL-1ME.E5
Power source	Build-in Ni-MH battery (AIPHONE WLW-BT.E) 2.4V DC (2000mAh)
Wireless type	DECT
Display	2.4 inch TFT color LCD monitor (240 x 320pixels)
Operation temperature	0 to 40 C (32 to 104F)
Dimensions	57(W)x150x(H)x27(D)mm
RF Transmission Frequency Range	1920MHz
RF Transmission Power	+24dBm (Max)
Wireless Video Intercom - Charging Stand	WLW-C.E
Power source	AC Adapter (BLJ06W050040P2-U) Input: 100V - 240V AC 50/60Hz Output: 5V DC 400mA
Operation temperature	0 to 40 C (32 to 104F)
Dimensions	84(W)x88(H)x63(D) mm
Available AC plug type	A-type
Wireless Video Intercom - Video Door Station	WL-DA.E5
Power source	6xAA size batteries (Ni-MH batteries with 2500mAh)
Operation temperature	-10 to +50 C (14 to 122 F)
Dimensions	100(W)x130(H)x42(D)mm
RF Transmission Frequency Range	1920MHz
RF Transmission Power	+24dBm (Max)

Caracteristiques Techniques

Destination		WL-11.E1 US et Canada
Wireless Vidéo Interphone - Moniteur	WL-1ME.E1 (FCC ID: 2ALNEWL1MEE1, IC: 4361A-WL1MEE1)	
Alimentation	Batterie Ni-MH (AIPHONE WLW-BT.E) 2.4V DC (2000mAh)	
Technologies sans fil	DECT6.0	
Affichage	2.4 inch TFT color LCD monitor (240 x 320 pixels)	
Tenue à la température	0 à 40°C (32 à 104°F)	
Dimensions	57(l)x150x(h)x27(p)mm	
Gamme des fréquences de transmission RF	1920 - 1930MHz	
La puissance de transmission RF	+18dBm (Max)	
Wireless Vidéo Interphone - Base chargeur	WLW-C.E + AC adaptateur (BLJ06W050040P2-U)	
Alimentation	100V - 240V AC 50/60Hz	
Consommation	2.4W (Max)	
Tenue à la température	0 à 40°C (32 à 104°F)	
Dimensions	84(l)x88(h)x63(p) mm	
Disponible prise de courant	A-type (US et Canada)	
Wireless Vidéo Interphone - Plantine de rue	WL-DA.E1 (FCC ID: 2ALNEWLDAE1, IC: 4361A-WLDAE1)	
Alimentation	6 piles AA (Batterie Ni-MH 2500mAh)	
Tenue à la température	-10 à 50°C (14 à 122°F)	
Dimensions	100(l)x130(h)x42(p) mm	
Gamme des fréquences de transmission RF	1920 - 1930MHz	
La puissance de transmission RF	+18dBm (Max)	

Destination		WL-1ME.E2 UK, EU, Australia and New Zealand
Wireless Vidéo Interphone - Moniteur	WL-1ME.E2	
Alimentation	Batterie Ni-MH (AIPHONE WLW-BT.E) 2.4V DC (2000mAh)	
Technologies sans fil	DECT	
Affichage	2.4 inch TFT color LCD monitor (240 x 320 pixels)	
Tenue à la température	0 à 40°C (32 à 104°F)	
Dimensions	57(l)x150x(h)x27(p)mm	
Gamme des fréquences de transmission RF	1880 - 1900MHz	
La puissance de transmission RF	+24dBm (Max)	
Wireless Vidéo Interphone - Base chargeur	WLW-C.E	
Alimentation	AC Adapter (BLJ06W050040P2-U) Input: 100V - 240V AC 50/60Hz Output: 5V DC 400mA	
Tenue à la température	0 à 40°C (32 à 104°F)	
Dimensions	84(l)x88(h)x63(p) mm	
Disponible prise de courant	BF-type (UK), C-type (EU), O-type (Australia and New Zealand)	
Wireless Vidéo Interphone - Plantine de rue	WL-DA.E2	
Alimentation	6 piles AA (Batterie Ni-MH 2500mAh)	
Tenue à la température	-10 à 50°C (14 à 122°F)	
Dimensions	100(l)x130(h)x42(p) mm	
Gamme des fréquences de transmission RF	1880 - 1900MHz	
La puissance de transmission RF	+24dBm (Max)	



AIPHONE CO.,LTD.,
10th floor Meiji Yasuda Seimei Nagoya Building,
1-1 Shinsakae-machi, Naka-ku, Nagoya, Aichi, 460-0004, JAPAN

Issued October 2018 (A) P1018KQ 61075