

AA-12FB

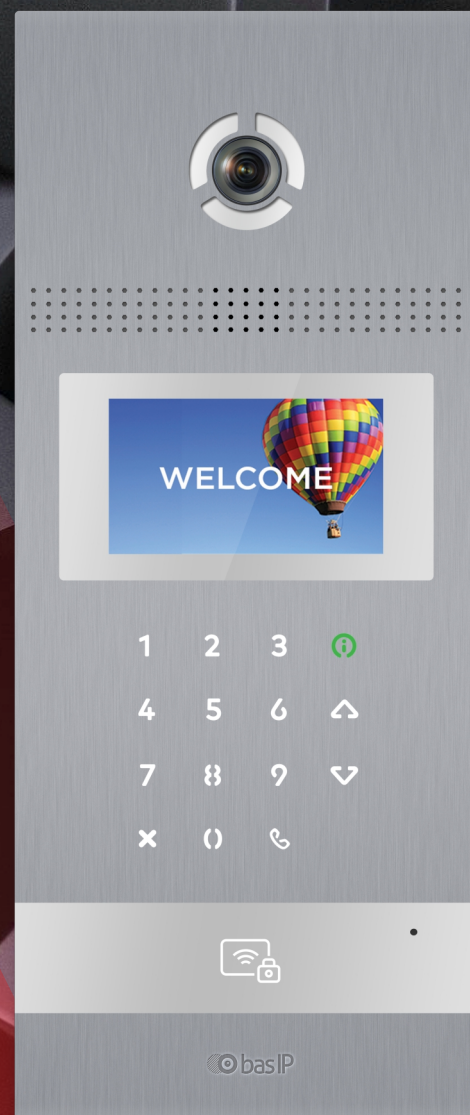

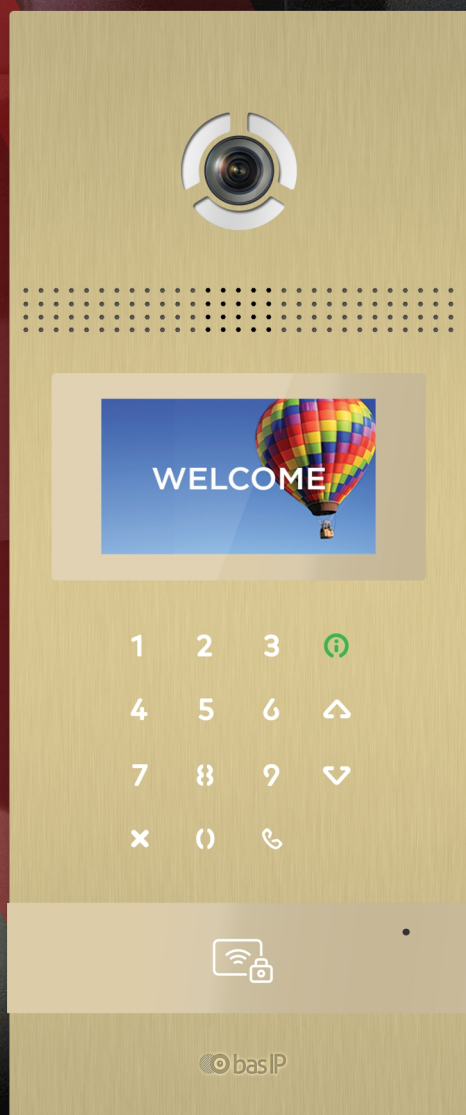
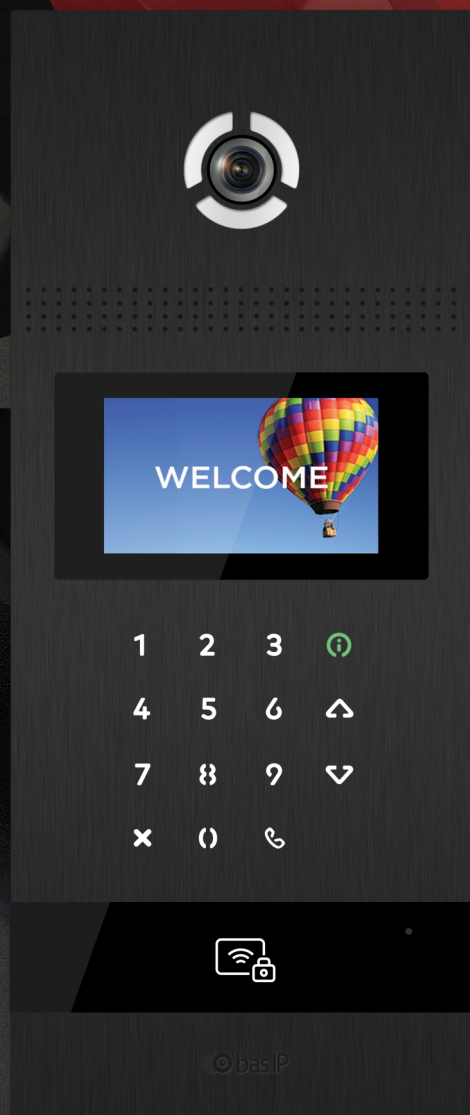
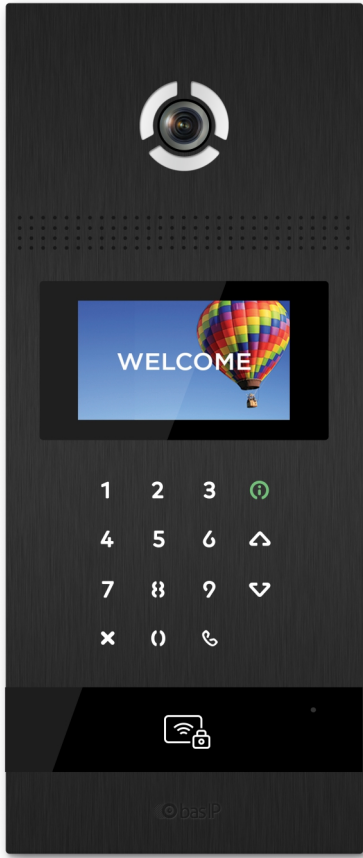

Main features

- Panel type: Multi-apartment.
- Display: 4.3" TFT, color with backlight.
- Keypad: Backlight piezo buttons.
- Camera: 1/4".
- Resolution: 2 Mp.
- Camera angle: 110° (horizontal).
- Output video: Full HD (1920 × 1080), H.264 Main Profile.
- Night backlight: 6 LEDs.
- Light sensitivity: 0,01 LuX.
- Protection class: IP65.
- IK-Code: IK07.
- Working temperature: -40 — +65 °C.
- Power consumption: 6,5 W, in standby — 3,6 W.
- Power supply: +12 V DC.
- Body: Aluminum.
- Colors: Silver, Gold, Black.
- Dimensions for installation: 142 × 358 × 58 mm.
- Size of the panel: 161 × 382 × 49 mm.
- Installation: Flush, surface with BR-AA12 bracket.

ENTRANCE PANEL

AA-12FB

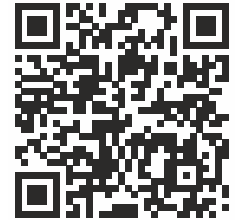

Full User Manual
wiki.bas-ip.com

Device description

Modern design and well-thought out functionality of this panel makes it an ideal solution for business and elite buildings. AA-12FB is available in gold, silver, and black, and also it supports BAS-IP UKEY mobile access.

There is a separate button to call concierge or emergency services.

Appearance

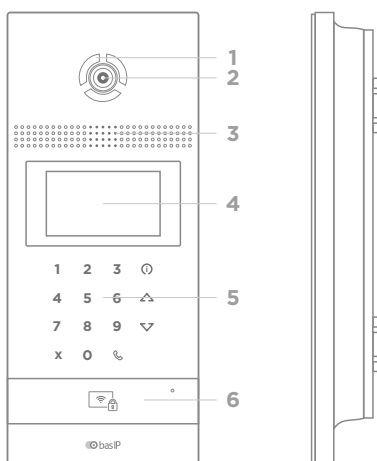

- | | |
|------------------|-------------------|
| 1 - Backlight. | 4 - 4.3" Display. |
| 2 - Camera. | 5 - Keypad. |
| 3 - Loudspeaker. | 6 - Reader. |

Completeness check of the product

Before installation of the outdoor panel, it is necessary to check that it is complete and all components are available.

Outdoor panel kit includes:

Outdoor panel	1 pc
Flush mount bracket	1 pc
Manual	1 pc
Set of wires with connectors for connection of power supply, lock, and additional modules	1 pc
A set of cups	1 pc
Set of screws with a wrench	1 pc

Electrical connection

After verifying the device's completeness, you can switch to the outdoor panel connection.

For connection you will need:

- An Ethernet UTP CAT5 or higher cable connected to a PoE network switch or regular switch/router.

Cable length recommendations

The maximum length of the UTP CAT5 cable segment should not exceed 100 meters, according to the IEEE 802.3 standard.

- Power supply at +12 V, 2 amps.

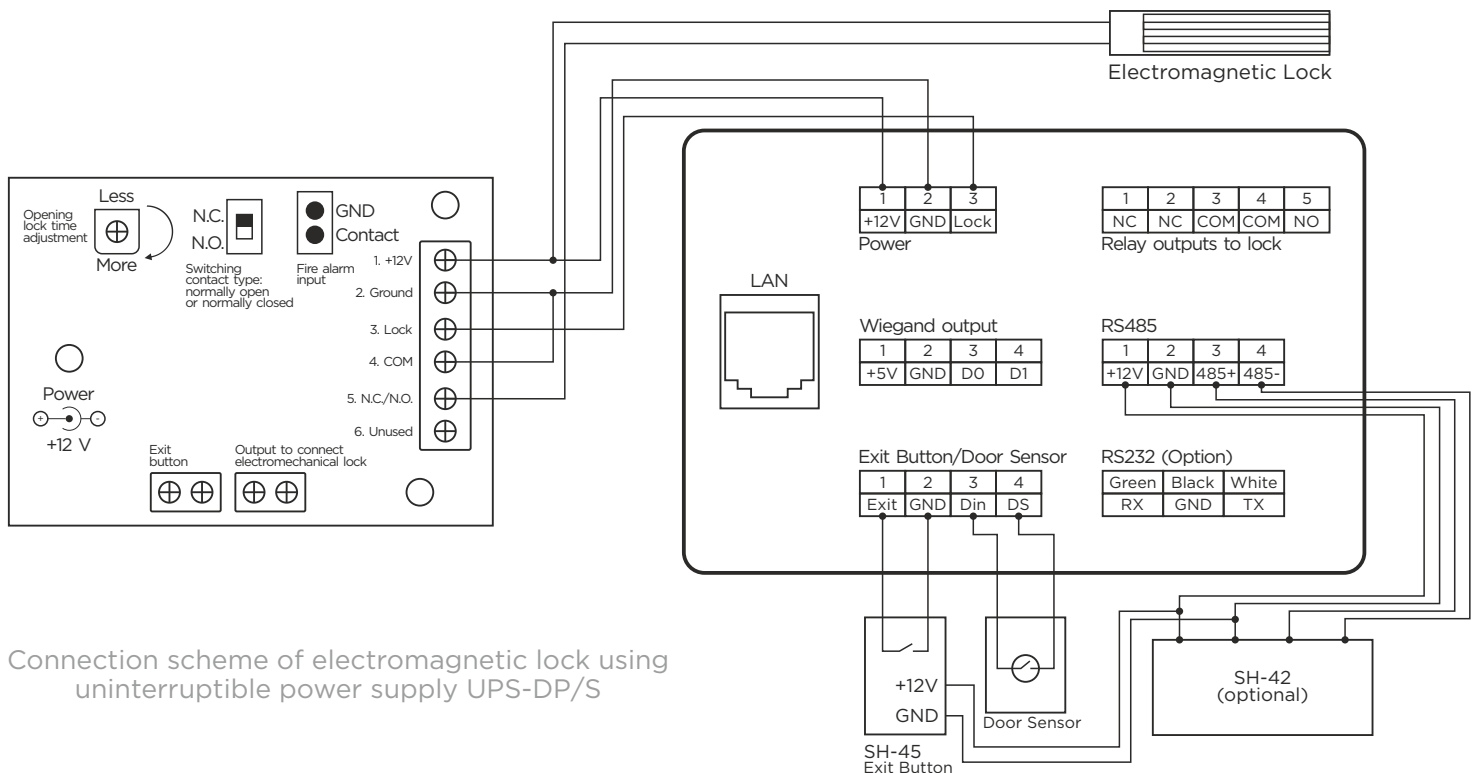

Connection scheme of electromagnetic lock using uninterruptible power supply UPS-DP/S

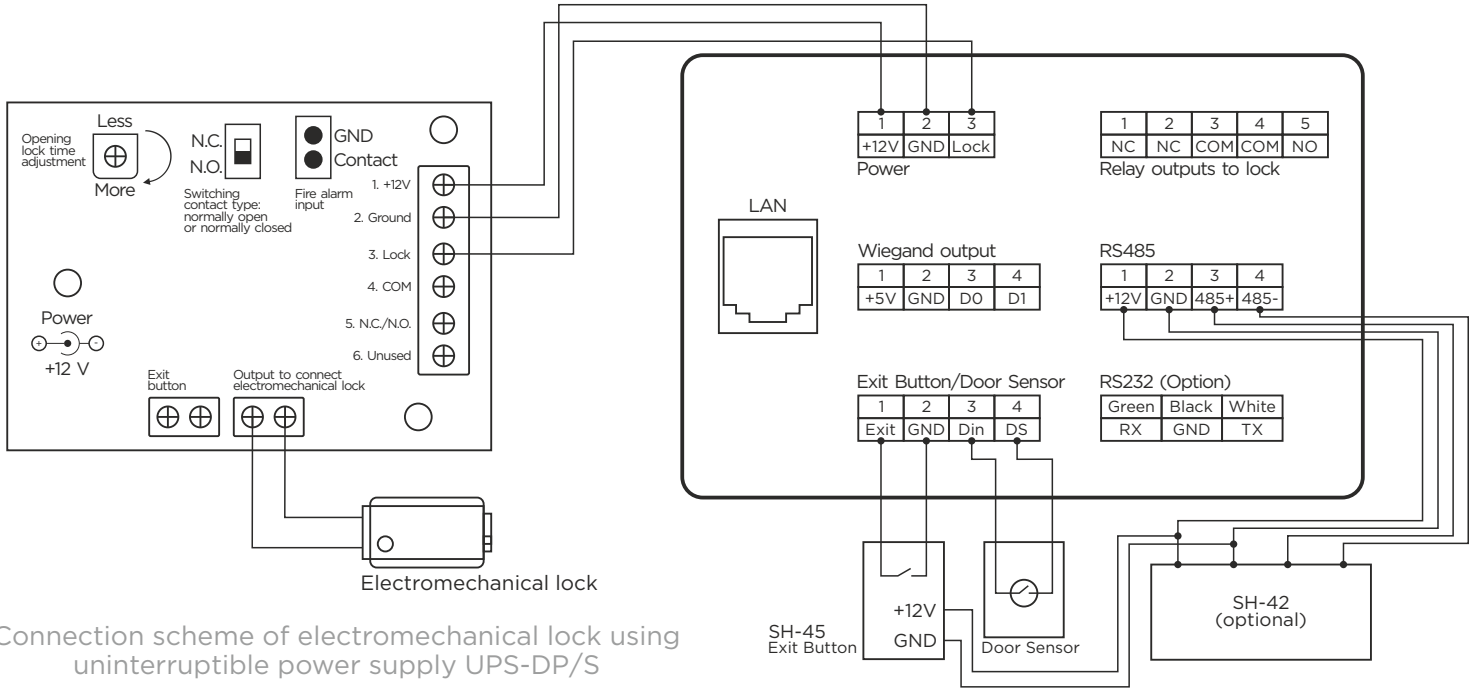

Connection scheme of electromechanical lock using uninterruptible power supply UPS-DP/S

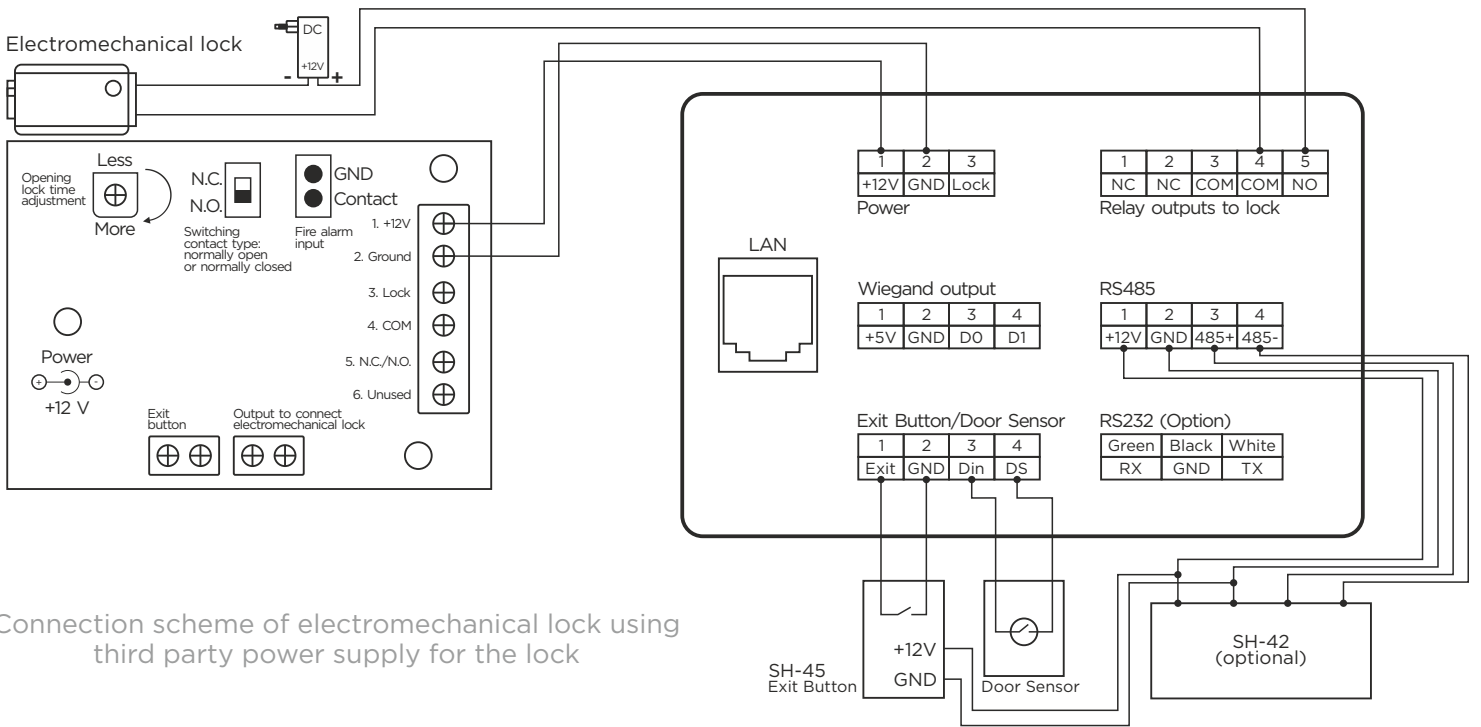

Connection scheme of electromechanical lock using third party power supply for the lock

Mechanical mounting

Before installation of the outdoor panel it is necessary to provide a hole or a recess into a wall with dimensions 144×360×59 mm (for flush mount) dimensions of the bracket (mounting box) = 142×358×58 mm.

It is also necessary to provide supply of a power cable, additional modules and the local network.

Attention: the hole at the bottom is designed to drain the water. Do not intentionally close it. Also it is necessary to make a drain for water at the bottom of the niche which will serve to divert water out.

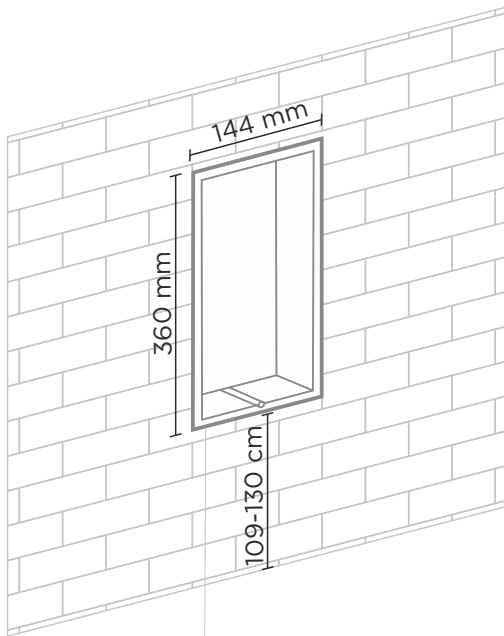

Niche

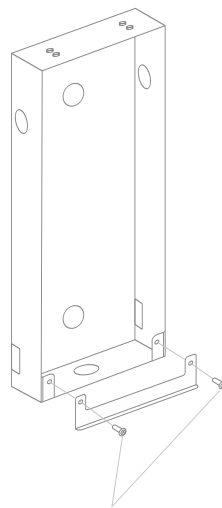

Screws

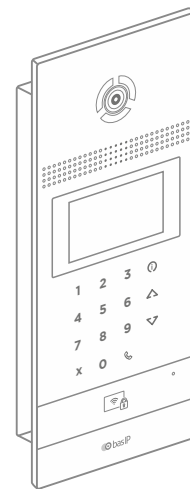

Outdoor Panel

Outdoor Panel

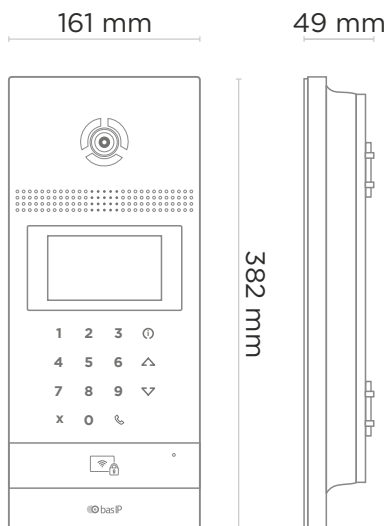

Flush Bracket

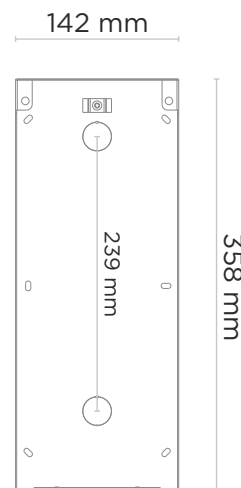

Warranty

The warranty card number _____

Model name _____

Serial number _____

Seller name _____

With following stated terms of warranty is familiar, functional test was performed in my presence:

Customer signature _____

Warranty conditions

The warranty period of the product — 36 (thirty-six) months from the date of sale.

- Transportation of product must be in its original packaging or supplied one by the seller.
- The product is accepted in warranty repair only with a properly filled warranty card and the presence of intact stickers or labels.
- The product is accepted for examination in accordance with the cases provided by law, only in the original packaging, in a full complete set, appearance corresponding to the new equipment and presence of all relevant properly filled documents.
- This warranty is in addition to the constitutional and other consumer rights and in no way restrict them.

Terms of warranty

- The warranty card must indicate the name of the model, serial number, purchase date, name of the seller, seller company stamp and the customer's signature.
- Delivery to the warranty repair is carried out by the buyer himself.
- Warranty repairs carried out only during the warranty period specified in the warranty card.
- The service center is committed to do everything possible to carry out the repair warranty products, up to 24 working days. The period spent on the restoration of product functionality is added to the warranty period.



www.bas-ip.com