

# AXWK WIRELESS KEYPAD

## MANUAL

### FEATURES:

1. 40 Access PINs + 1 Primary PIN
2. Extended Access: Once a valid PIN is entered and sent, any number key will operate the gate for at least 30 seconds. Each key pressed restarts the 30 second timer.
3. PartyMode: Hold gate open.
4. PartyMode Secure or 1-Key Mode: Any key on the keypad can operate the gate.
5. VacationMode: Disable all wireless transmitter.
6. Time based temporary PINs: Automatically expired after X number of days.
7. Number of use based Temporary PINs: automatically expired after X number of uses.
8. Compatible with ALL Ghost Controls gate opener system.
9. Compatible with most automatic gate systems when used with the Ghost Controls Universal Receiver AXUR.

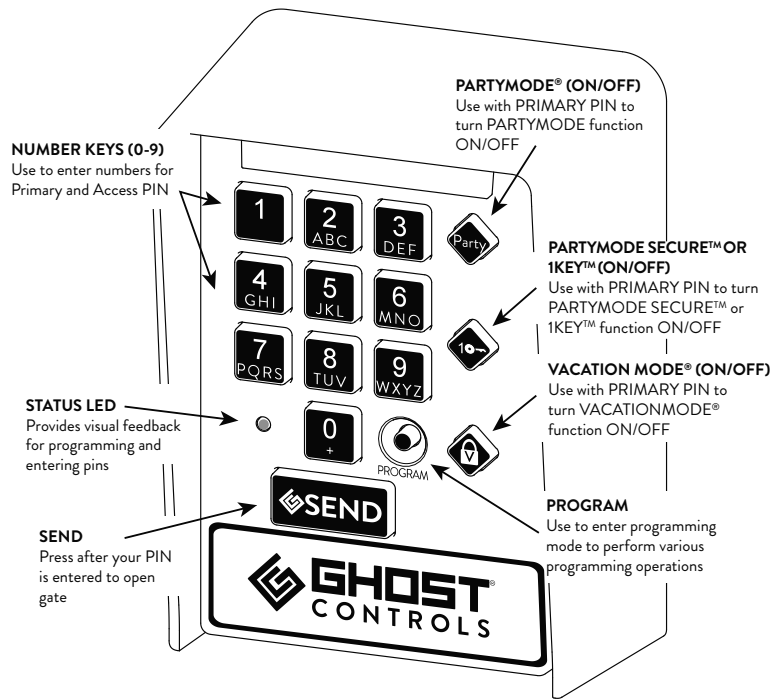

### PROGRAMMING THE KEYPAD FOR THE 1ST TIME:

A. Installing the batteries (Need 2 C Batteries)	2
B. Programming your keypad (MUST DO)	2
C. Test PRIMARY PIN	3
D. Mounting the keypad	3
Adding additional ACCESS PIN	4
Adding a time based temporary ACCESS PIN	4
Adding a use based temporary ACCESS PIN	4
Delete an ACCESS PIN	5
Delete all ACCESS PINs	5
Changing your 4 Digit PRIMARY PIN	6
Replaced remote transmitter or changed your remote transmitter code to your gate	6
Enable PartyMode	7
Disable PartyMode	7
Enable Partymode Secure or 1-Key mode	7
Disable PartyMode Secure or 1-Key mode	7
Enable VacationMode	8
Disable VacationMode	8
Factory reset the keypad	8
Troubleshooting	9

## IMPORTANT MUST READ BEFORE PROGRAMMING

- Make sure you have a Ghost Controls transmitter that is already programmed to operate the gate.
- You **MUST CREATE** a NEW PRIMARY PIN and LEARN your remote to the keypad in order to use the keypad.
- ALL LEDs including the backlight LEDs must be OFF (Sleep mode) prior to enter any of the programming mode.

### AUDIBLE INDICATORS

- Long beep (2-3 seconds) followed by 2 short beeps = PROGRAMING ERROR
- 3 long beeps, pause, then 2 short beeps = PROGRAMING SUCCESSFUL
- 2 beeps then ALL LEDs TURN OFF = Unit went into sleep mode due to inactivity.

## PROGRAMMING THE KEYPAD FOR THE 1ST TIME

**A. INSTALLING THE BATTERIES:** Use only C-Size Alkaline Batteries (2 needed). Energizer or Duracell recommended.

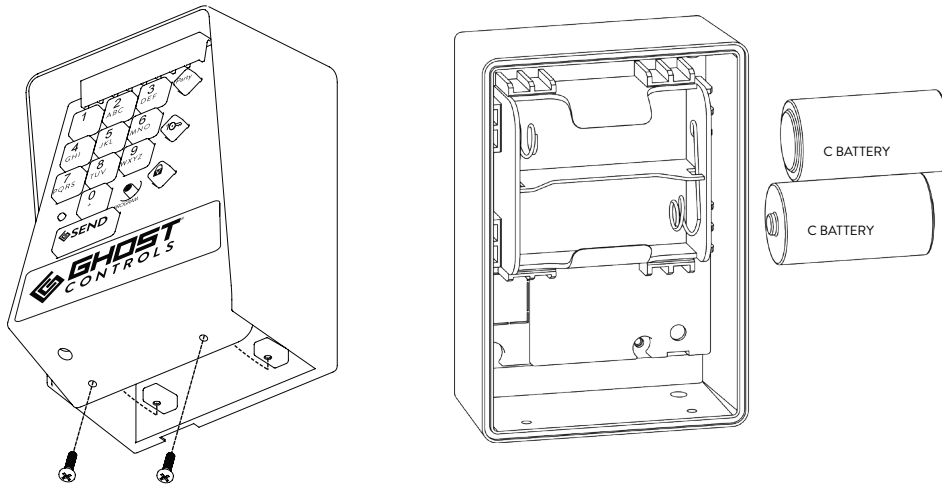

### NOTE

You will need to have your working remote transmitter (one that operates the gate) available for these next steps.

**B. PROGRAMMING YOUR KEYPAD:** (DO NOT GIVE OUT PRIMARY PIN FOR ACCESS)

The following steps below 1 - 5 are required and can only be performed on new keypads or after a factory reset.



1. Press and Release PROGRAM BUTTON  LED IS SOLID

2. Enter a new 4 digit PRIMARY PIN 

 LED IS BLINKING

3. Re-enter new 4 digit PRIMARY PIN

 LED TURNS OFF  LED WILL COME ON

4. Place the transmitter as shown and press the transmitter button that operates the gate.  OR 

 LED WILL TURN OFF (when the transmitter code was accepted)

 LED WILL COME ON (now program 4 digit access pin for guests)

5. Enter a 4 digit access pin 

(this access pin is to give out to family and friends)

 LED WILL TURN OFF (when access pin was accepted)

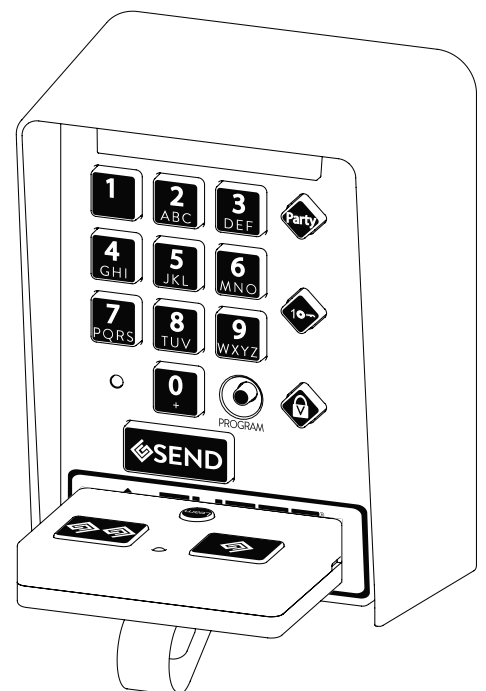



## ADD ADDITIONAL ACCESS PINS (CANNOT USE 0 0 0 0):

1. Press and Release PROGRAM BUTTON  
(the PartyMode, 1-Key, Vacation LEDs comes on)



2. Enter your PRIMARY PIN



3. Press and Release PROGRAM BUTTON



4. Enter 2 2



5. Press and Release PROGRAM BUTTON



6. Enter additional 4 DIGIT ACCESS PIN



7. Press and Release PROGRAM BUTTON



## ADD A TIME BASED TEMPORARY ACCESS PIN:

(access pin will work for a certain number of days and cannot be 0 0 0 0)

1. Press and Release PROGRAM BUTTON  
(the PartyMode, 1-Key, Vacation LEDs comes on)



2. Enter your PRIMARY PIN



3. Press and Release PROGRAM BUTTON



4. Enter 2 3



5. Press and Release PROGRAM BUTTON



6. Enter NEW TIME BASED ACCESS PIN



7. Press and Release PROGRAM BUTTON



8. Enter the NUMBER OF DAYS Allowed  
EXAMPLE: for 5 days.... 0 5



9. Press and Release PROGRAM BUTTON



## ADD A USE BASED TEMPORARY ACCESS PIN: (access pin will work for a number of uses)

1. Press and Release PROGRAM BUTTON  
(the PartyMode, 1-Key, Vacation LEDs comes on)



2. Enter your PRIMARY PIN



3. Press and Release PROGRAM BUTTON



4. Enter 2 8
5. Press and Release PROGRAM BUTTON
6. Enter NEW USE BASED ACCESS PIN
7. Press and Release PROGRAM BUTTON
8. Enter the NUMBER OF USES Allowed  
EXAMPLE: for 5 uses.... 0 5
9. Press and Release PROGRAM BUTTON

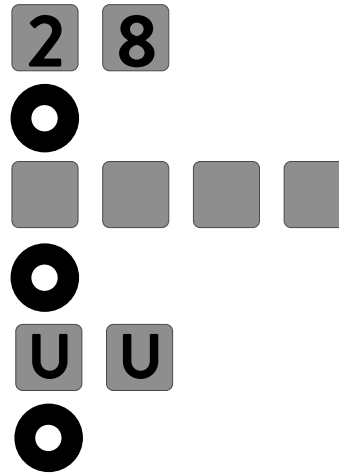

### DELETE AN ACCESS PIN: (deleted pin will no longer operate the gate)

1. Press and Release PROGRAM BUTTON  
(the PartyMode, 1-Key, Vacation LEDs comes on)
2. Enter your PRIMARY PIN
3. Press and Release PROGRAM BUTTON
4. Enter 3 2
5. Press and Release PROGRAM BUTTON
6. Enter ACCESS PIN to be DELETED
7. Press and Release PROGRAM BUTTON

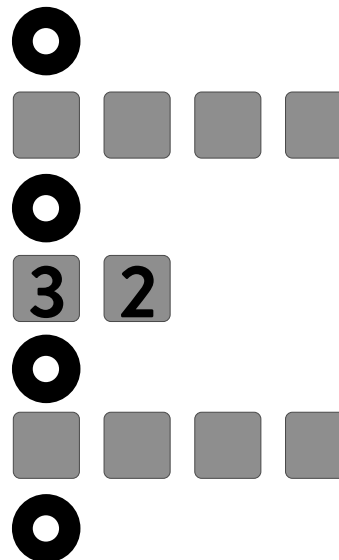

### DELETE ALL ACCESS PINS: (ALL access pins are deleted, Primary Pin is only one able to operate the gate)

1. Press and Release PROGRAM BUTTON  
(the PartyMode, 1-Key, Vacation LEDs comes on)
2. Enter your PRIMARY PIN
3. Press and Release PROGRAM BUTTON
4. Enter 3 3
5. Press and Release PROGRAM BUTTON

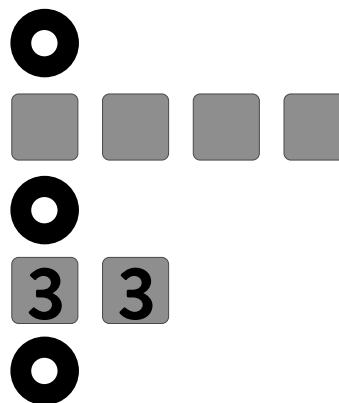

## CHANGING YOUR 4 DIGIT PRIMARY PIN (CANNOT USE 0 0 0 0):

1. Press and Release PROGRAM BUTTON  
(the PartyMode, 1-Key, Vacation LEDs comes on)



2. Enter your PRIMARY PIN



3. Press and Release PROGRAM BUTTON



4. Enter 7 6



5. Press and Release PROGRAM BUTTON



6. Enter NEW 4 DIGIT PRIMARY PIN  
YOU CAN NOT USE 0 0 0 0



7. Press and Release PROGRAM BUTTON



## REPLACED REMOTE TRANSMITTER OR CHANGED YOUR REMOTE TRANSMITTER CODE TO YOUR GATE:

1. Press and Release PROGRAM BUTTON  
(the PartyMode, 1-Key, Vacation LEDs comes on)

2. Place the transmitter as shown and press the transmitter button until the Party, 1-key and Vacation LEDs on the keypad are blinking in alternating sequence.  
(If the transmitter has already been programmed into keypad, the unit will auto exit programming mode. Entering Primary Pin is not required below)

3. Enter your PRIMARY PIN



4. Press and Release PROGRAM BUTTON

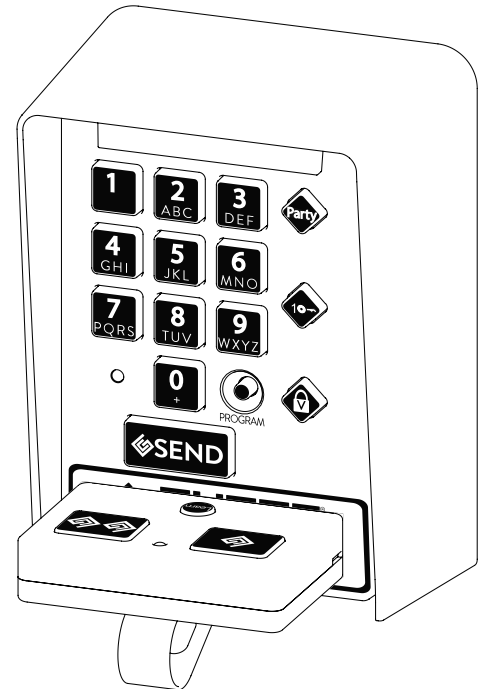

## ENABLE PARTYMODE: (this holds your gate open)

When Partymode is enabled the gate will stay open and autoclose (if enabled) is suspended. The gate opener will BEEP TWICE if attempting to close the gate while PartyMode is enabled.

1. Press and Release PARTY BUTTON



2. Enter your PRIMARY PIN



3. Press SEND



## DISABLE PARTYMODE:

When Partymode is disabled the gate will BEEP THREE (3) TIMES to indicate that it is exiting PartyMode.

1. Press and Release PARTY BUTTON



2. Enter your PRIMARY PIN



3. Press SEND



**NOTE: IF THE ABOVE DOES NOT DISABLE PARTYMODE TURN THE GATE OPENER OFF AT CONTROL BOX AND THEN BACK ON AND THIS WILL EXIT PARTYMODE.**

**ENABLE PARTYMODE SECURE OR 1-KEY MODE:** (Pressing any # key on the keypad allows guest to enter your property while keeping it secure because the gate shuts after each guest when autoclose is set) The PartyMode Secure button will stay lit for a few seconds letting you know PartyMode Secure is enabled.

This mode is useful when a guest is not required to use a PIN to operate the gate such as when it is installed on the inside of the property for guests to exit property. **We recommend that the Autoclose feature on the gate opener is enabled when using this feature.**

1. Press and Release 1-KEY BUTTON

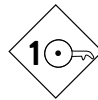

2. Enter your PRIMARY PIN



3. Press SEND



## DISABLE PARTYMODE SECURE OR 1-KEY MODE:

When Partymode Secure is disabled the gate will go back its normal programmed autoclose gate setting.

1. Press and Release 1-KEY BUTTON



2. Enter your PRIMARY PIN



3. Press SEND



**ENABLE VACATION MODE:** (This keeps your gate closed and all remotes or codes to keypad are Denied access to property until taken off this mode) **THE GATE MUST BE FULLY CLOSED BEFORE PUTTING IN THIS MODE.**

When Vacation Mode is enabled the gate will stay closed and all RF remote devices that control the gate will not be able to open the gate. The gate opener will BEEP TWICE if attempting to open the gate while Vacation Mode is enabled.

A. Press and Release VACATION BUTTON



B. Enter your Primary Pin



C. Press SEND



## DISABLE VACATION MODE:

When Vacation Mode is disabled the gate opener will BEEP THREE (3) TIMES to indicate Vacation Mode is disabled.

A. Press and Release VACATION BUTTON



B. Enter your Primary Pin



C. Press SEND



**NOTE: IF THE ABOVE DOES NOT DISABLE VACATION MODE TURN THE GATE OPENER OFF AT CONTROL BOX AND THEN BACK ON AND THIS WILL EXIT VACATION MODE.**

## FACTORY RESET THE KEYPAD: (Do this only when Primary Pin has been forgotten)

- Remove one of the C Batteries from the keypad and then press any button on the keypad.
- Reinsert the battery, wait for the keypad to beep 3 times.
- Immediately press and release the PROGRAM BUTTON 3 times.
- The keypad will perform 3 long beeps followed by 2 short beeps to indicate successful factory reset.
- MUST perform "PROGRAMMING THE KEYPAD FOR THE 1ST TIME" again.



## TROUBLESHOOTING:

QUESTIONS	ANSWERS
After entering my PIN, any key would open/close the gate.	This is normal. After valid PIN is entered and send, any number key on the keypad will operate the gate until the keypad returns to Standby Mode.
I did not enter a PIN, but any key would open/close the gate.	Make sure the '1-Key' button LED (Green) is not on. If it is, then the keypad is in '1-Key' mode. To disable 1-key mode, press the '1-key' button, enter the PRIMARY PIN and press the SEND button. The '1-Key' button LED should turn off. Wait 60 seconds and test. If still in "1-Key" mode remove one C battery and wait 15 seconds reinstall battery and retest.
Why are none of my keypad keys illuminated?	Keypad is in <b>Standby Mode</b> . In Standby mode, the keypad LEDs are not lit up and the keypad requires the PRIMARY PIN or an ACCESS PIN to be entered. When PRIMARY PIN is used the PartyMode, 1-Key and the Vacation Mode LEDs will be blinking in alternating sequence.
I entered a PIN, the gate opener beeps 1-time but will not open.	The PIN you entered is invalid. The 1-beep means the gate 'sees' the signal but the PIN is invalid.
I entered a PIN, the gate opener beeps 2-times but will not open.	VacationMode is enabled on the gate. See <b>ENABLE/DISABLE VACATIONMODE</b> or turn the gate controller OFF then back ON.
I entered a PIN, the gate opener beeps 2-times but will not close.	PartyMode is enabled on the gate. See <b>ENABLE/DISABLE PARTYMODO</b> or turn the gate controller OFF then back ON.
When I press any key, the keypad gives 3 long beeps follow by 2 short beeps.	The keypad is still in factory default setting. Please go to ' <b>PROGRAMING THE KEYPAD FOR THE 1ST TIME</b> ' and complete the steps.
The keypad gives 2 long beeps with all the LEDs flashing twice randomly or when I use the keypad.	The keypad is performing a power on check when battery 1st installed. Check and change the batteries if necessary.
Do I need to reprogram everything when I change the battery?	NO
Can I have more than one keypad to control the same gate?	YES
Why did my keypad stop working? or My keypad worked yesterday and now it does not work today?	Replace two C-size batteries in keypad.

# ADD YOUR PINS HERE

PRIMARY  
PIN

ACCESS PIN

ACCESS PIN

ACCESS PIN

## WARNING

Changes or modifications to this unit not expressly approved by the party responsible for compliance could void the user's authority to operate the equipment.

## NOTE:

This equipment has been tested and found to comply with the limits for a Class B digital device, pursuant to Part 15 of the FCC Rules. These limits are designed to provide reasonable protection against harmful interference in a residential installation. This equipment generates, uses and can radiate radio frequency energy and, if not installed and used in accordance with the instructions, may cause harmful interference to radio communications. However, there is no guarantee that interference will not occur in a particular installation.



**WARNING:** This product can expose you to chemicals including lead, which is known to the State of California to cause cancer.

For more information, go to [www.P65Warnings.ca.gov](http://www.P65Warnings.ca.gov)



GhostControls.com

Made in China, AXWKIM | Rev. 2021-04  
©2021 GHOST CONTROLS®