



Video Intercom Installation Guide

Valid for GateHawk Gen3 intercom models (7-Inch with Keypad, 10-Inch with Keypad, and 12-Inch Touchscreen)



In order to make sure that GateHawk technology offers a valuable experience for all customers and users, all hardware associated with GateHawk features must be installed carefully and accurately. This document outlines the installation steps required to properly install a GateHawk Video Intercom system. The following steps should be precisely followed by a qualified technician to ensure system functionality and user safety. All local and national electric codes should be followed as these steps are completed.

For additional product information, please visit dealer-support.gatehawk.com

This device complies with part 15 of the FCC Rules. Operation is subject to the following two conditions: (1) This device may not cause harmful interference, and (2) this device must accept any interference received, including interference that may cause undesired operation.

Changes or modifications not expressly approved by the manufacturer could void the user's authority to operate the equipment

Note:

This equipment has been tested and found to comply with the limits for a Class A digital device, pursuant to part 15 of the FCC Rules. These limits are designed to provide reasonable protection against harmful interference when the equipment is operated in a commercial environment. This equipment generates, uses, and can radiate radio frequency energy and, if not installed and used in accordance with the instruction manual, may cause harmful interference to radio communications. Operation of this equipment in a residential area is likely to cause harmful interference in which case the user will be required to correct the interference at his own expense.

This product has been found to be compliant to the requirements set forth in CFR 47 Section 1.1307 addressing RF Exposure from radio frequency devices, as defined in Evaluating Compliance with FCC Guidelines for Human Exposure to Radio Frequency Electromagnetic Fields. This device must be installed and operated so as to maintain a minimum separation distance to any person of 20 cm (8.7 inches).

Before you begin

Each video intercom system requires the following wiring:

- 16/2 or 18/2 for power. Use the table below for recommended maximum distances for the power wires.

Wire Gauge	Max Distance
14	275 ft
16	175 ft
18	100 ft

- 22/6 Shielded for Wiegand or relays. The maximum recommended distance is 300ft. The system includes two Form C relays, rated for 4A at 30V each.
- One CAT 5e or CAT 6 for wired ethernet
- Earth Ground for surge damage protection

16 AWG stranded wire or thicker and the length of wire should not exceed 50 feet.

Wire must be connected from the bottom left corner of the main motherboard inside the Video Intercom to a ground rod or cold water pipe.

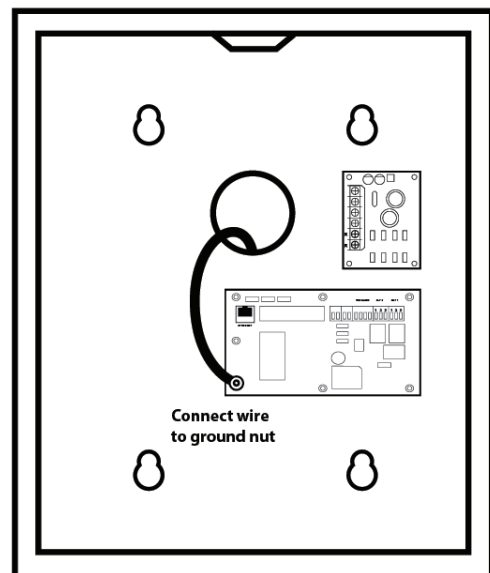

Included items

Each of your Video Intercom installation packages will include the following essential tools:

Quantity	Item
1	Mounting Template
4	Concrete Anchors
4	Lag Bolts ¼ x 2"
1	TP2450 AC Transformer
1	Microfiber Cloth (Yellow)
2	Security Key

Please note that LittleBird does not provide wiring for power, Wiegand, or ethernet. All wiring must be run prior to intercom's installation. Refer to the wiring and grounding requirements listed in this guide for further details.

What you'll need

Proper installation of your Video Intercom unit requires the following tools. Be sure to have them available before you begin the installation process.

- Electric drill/ Hammer drill *
- 5/32 drill bit for wood
- 3/8 concrete bit *
- 7/16 inch socket w/ ratchet
- Philips screw driver
- Level
- Pencil

** The use of this item depends on the mounting surface you're working with.*

Installation instructions

We recommend that you have an additional member of your team assist you during this installation process.

Note: When locking and unlocking the Video Intercom unit, press the faceplate inward to compress the seal and then turn the lock. This will alleviate any pressure on the lock and allow the lock to spin with less resistance.

STEP 1: Make your marks

Using the included mounting template, mark the Video Intercom's four mounting holes on your installation area's surface following ADA guidelines.

For the **GHVIG3-12T** model, the bottom two mounting holes should be **38"** from the floor.

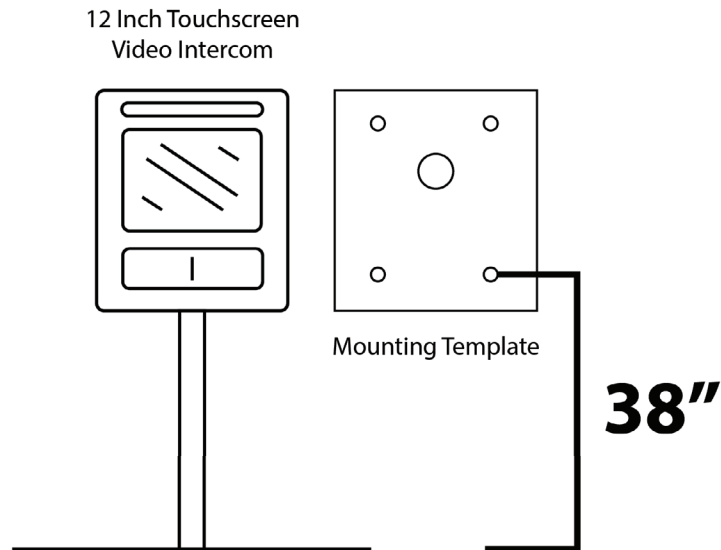

For the **GHVIG3-10K** and **GHVIG3-7K** models, the bottom two mounting holes should be **43.25"** from the floor.

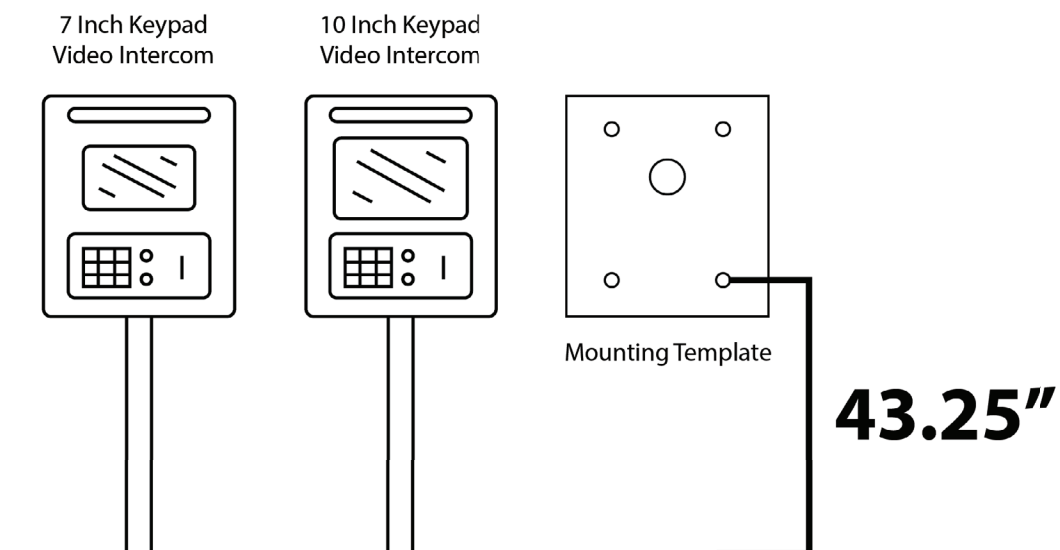

STEP 2: Level and drill

Level the mounting template and then drill the four marked mounting holes.

Installation Material	Bit size
Wood	15/64"
Concrete, block, or masonry	3/8"

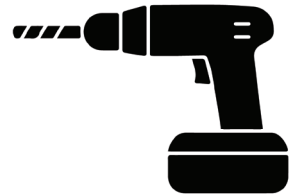
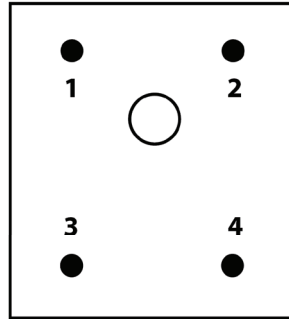

STEP 3: Wall anchors

If you're mounting the intercom to concrete, block, or masonry insert the provided wall anchors into the four mounting holes. If mounting to wood, do not use the provided anchors.



X4
Wall Anchors



Do Not
Use Wall Anchors on Wood

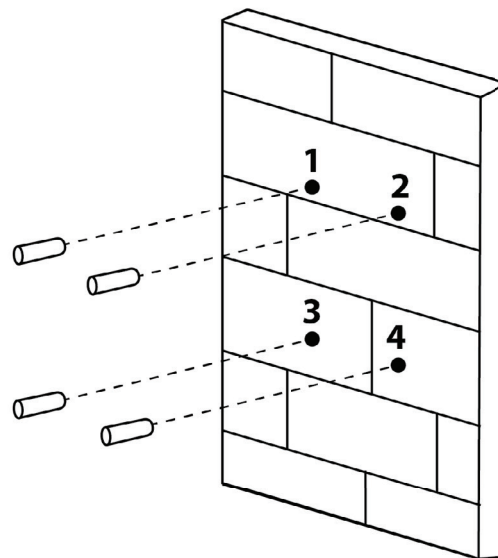

STEP 4: Lag bolts

Install lag bolts into the top two holes, leaving about a 1/2" gap.

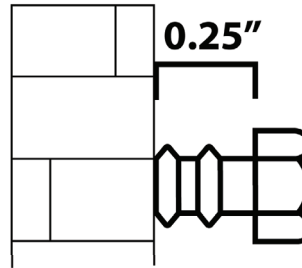
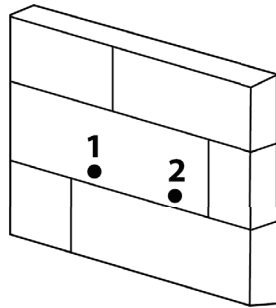
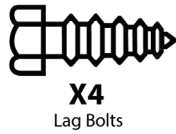

Do Not
Tighten Lag Bolts all the way

STEP 5: Mounting

Feed the power, Wiegand, and ethernet wires through the center hole in the back of the intercom.

STEP 6: Mounting cont.

Use the top two keyed holes of the video intercom to mount the unit onto the lag bolts. Pull down on the enclosure to ensure a tight fit.

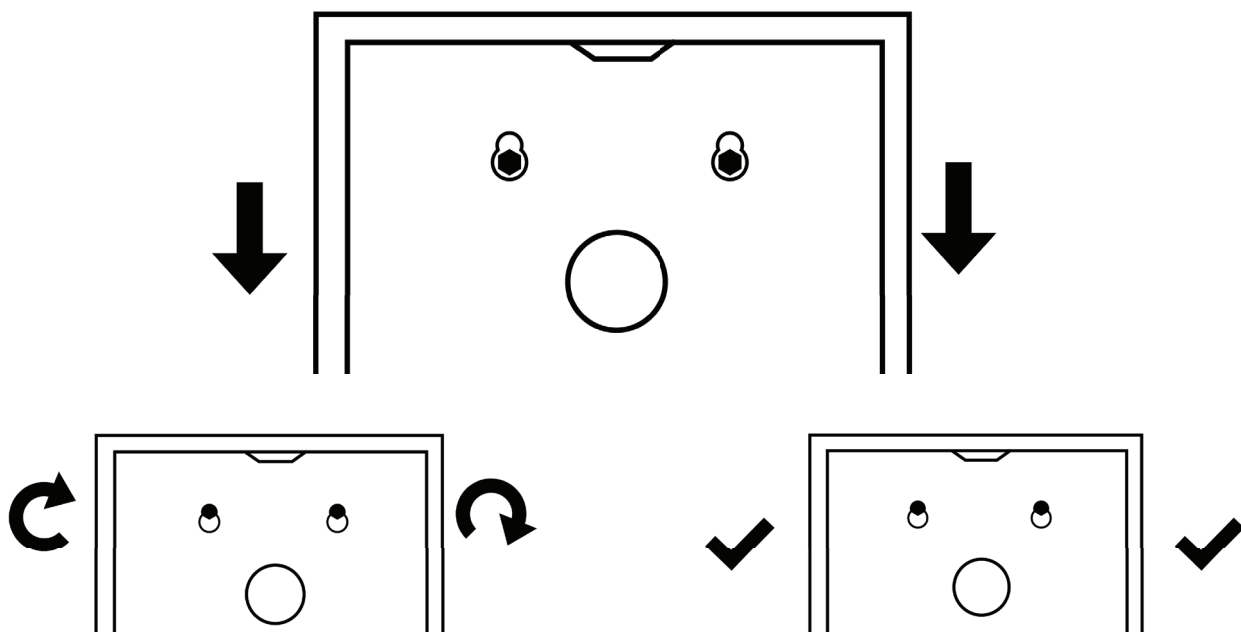

STEP 7: Mounting cont.

Now tighten the top two lag bolts.

STEP 8: Lag bolts cont.

Install the remaining two bottom lag bolts and tighten them completely.

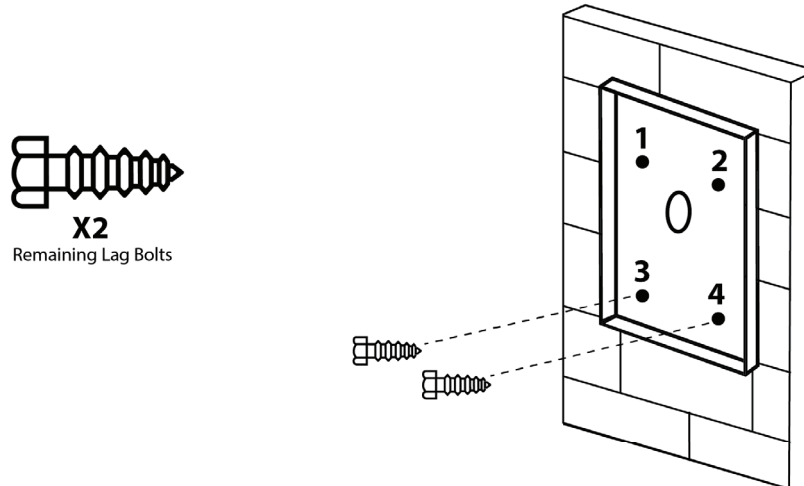

STEP 9: Ethernet

Plug in the ethernet wire into the ethernet jack on the board.

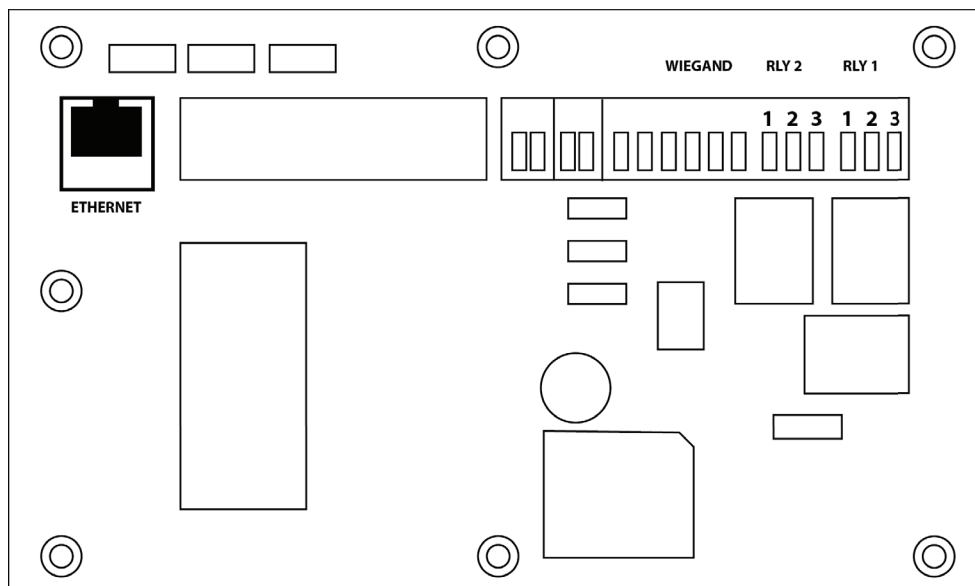

STEP 10: Wiegand

Plug in the Wiegand or relay wires into the removable terminals on the board.

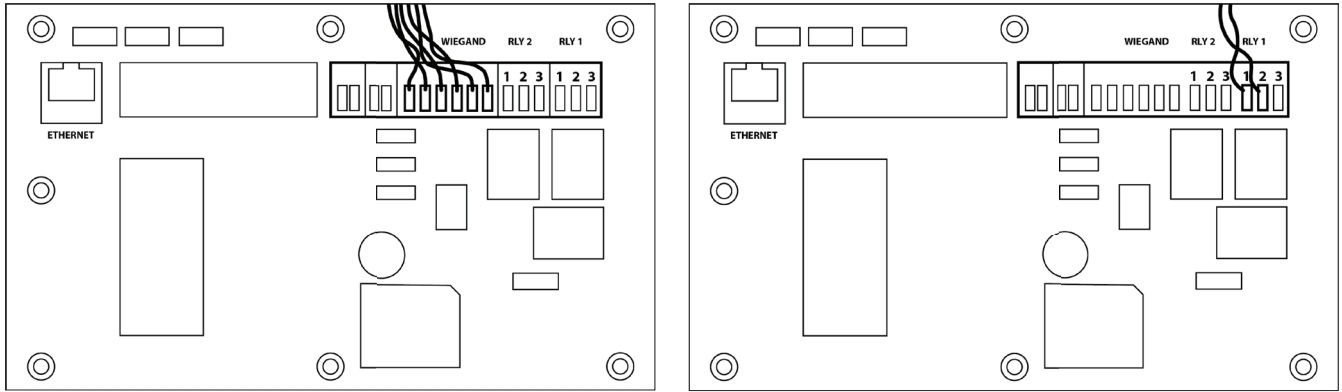

STEP 11: Power

Insert the two power wires into the AC terminals on the power supply.



X2
Fork Terminal Connector

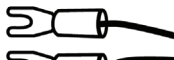

X2
Crimped Power Wires

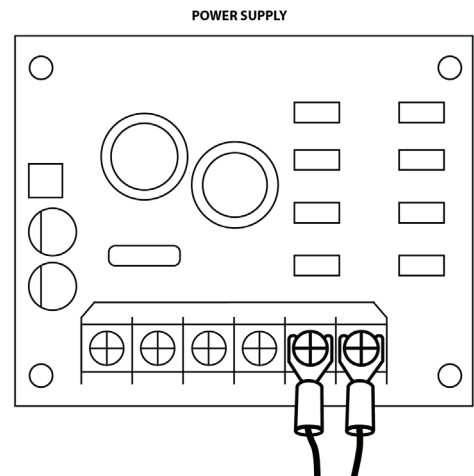
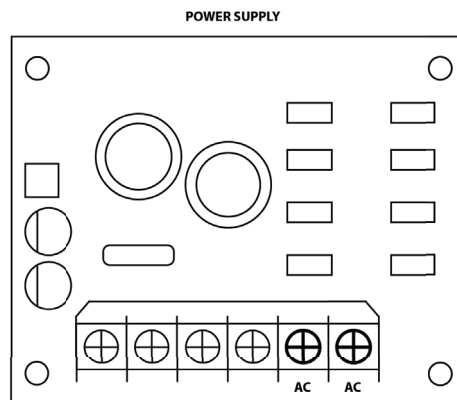

STEP 12: Power cont.

At the head end, attach the two power wires to the transformer, using the provided fork terminal connectors.

STEP 13: Power cont.

Crimp two fork terminal connectors to the wires that attach to the transformer.

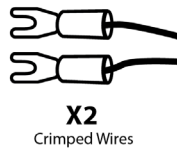

STEP 14: Power cont.

Plug in the transformer to power up the Video Intercom unit.

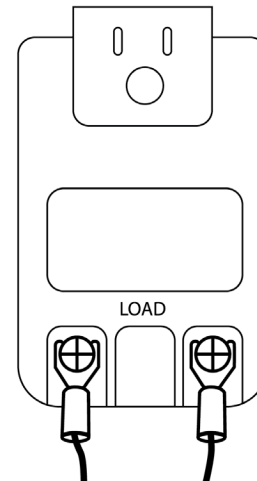

STEP 15: System start-up

Wait for the Video Intercom system to boot up. You should see a screen similar to this one when it's done booting.

Note that the layout of menu screens on each unit type will vary slightly.

In order to view the correct property name at the top of the unit screen, you'll need to activate the unit in the GateHawk Dealer Portal by attaching it to the property. This step can be done after installation is complete.

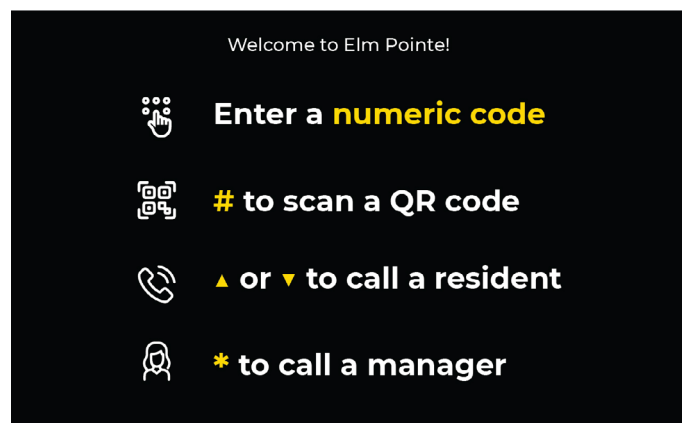

STEP 16: Completing the installation

When the setup start-up is complete, close and lock the lid with the provided keys.

BONUS: Cleaning the video intercom

Dust and moisture buildup may necessitate a routine cleaning of the unit to keep the screen clear and the unit looking nice. Simply use water and the provided microfiber cloth to clean the screen, metal, and plastic.