

SLR - SLC - SLD

Slide Gate Operator

Installation Guide

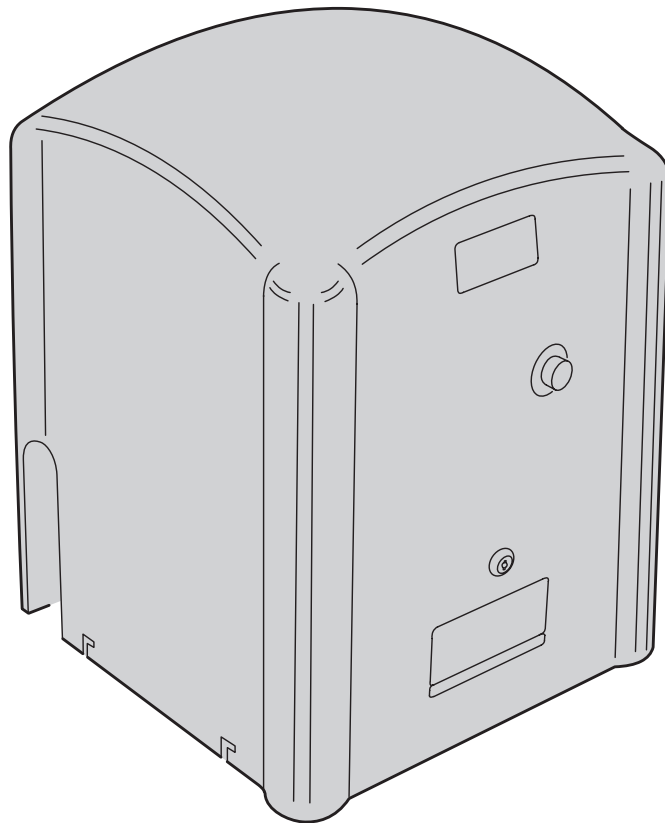

Intertek

Operator models contained in this manual
conform to UL325 standard for use in
Class I, II, III, and IV applications

Linear[®]

USA & Canada (800) 421-1587 & (800) 392-0123
(760) 438-7000 - Toll Free FAX (800) 468-1340

www.nortekcontrol.com

Table of Contents

- Pre-installation Information1
 - Before You Begin.....1
 - Always Check the Gate's Action1
 - Gate Operator Classifications1
 - Approved Obstruction Detection Devices1
- Safety Information and Warnings1
 - Regulatory Warnings1
- Wiring Specifications2
 - AC Power Wiring2
 - DC Control and Accessory Wiring2
- Mounting Pad Installation3
 - Gate Preparation3
- Gate Bracket and Chain Assembly4
- Operator Preparation5
 - Vent Plug Installation5
- Operator Setup5
 - Controller Access5
 - AC Power Connection5
 - Earth Ground5
 - Limit Nuts Rough Adjustment6
 - Limit Nuts Fine Adjustment6
- Controller Features7
- Indicator Descriptions8
- Terminal Descriptions9
- Operator Accessory Connections10
- Basic Controller Programming11
 - Programming Overview11
 - Entering Programming Mode11
 - Exiting Programming Mode11
 - Programming Keystrokes11
 - Left or Right Hand Operation11
 - Dual Gate Enable11
 - Auto Close Timer11
 - Run Alarm and Pre-start Alarm12
 - Maximum Open Direction Current Setting12
 - Maximum Close Direction Current Setting12
- Advanced Controller Programming13

- Entering Advanced Programming Mode13
- Maximum Run Time13
- Single Button Input Setup13
- Stagger Mode13
- Stagger Delay Time14
- Auxiliary Relay Mode14
- Reverse Delay Time14
- Constant Pressure Mode14
- Shadow Loop Open Prevention15
- Low Power Mode15
- Power Failure Mode15
- Soft Start/Stop Duration16
- Reset Cycle Count16
- Maintenance Alert Trigger16
- Mid-travel Stop Position17
- Anti-tailgate Enable17
- Motor Type Selection17
- Radio Enable18
- Antenna Installation18
- Radio Transmitter Learn18
- Radio Transmitter Delete18
- MGT Obstacle Transmitter Learn18
- MGT Obstacle Transmitter Delete18
- Reset Controller to Factory Defaults18
- Loop Layout Illustration19
- Safety Edge Layout Illustration #120
- Safety Edge Layout Illustration #221
- Photoeye Installation Illustration22
- Picket Gate Installation23
- Track Gate Installation24
- Dual Gate Installations25
- Gate Operation26
 - Open Button26
 - Close Button26
 - Stop Button26
 - Single Input26
 - Fire Department Input26
 - Open Input26
 - Open Obstruction26
 - Close Obstruction26
 - Reverse Input26
 - Open Loop26
 - Reverse Loop26
 - Shadow/reset Loop26
- Operation Indications26
 - Power-up Display26
 - Idle Condition26
 - Last Gate Position/Condition26
 - Pre-start Delay26
 - Reverse Delay26
 - Run Timer26
- Error Indications27
 - Entrapment27
 - COMM LINK Connection Failure27
 - MGT Obstacle Transmitter Trouble27
 - Maximum Run Time Exceeded27
- Troubleshooting28
 - Contacting Technical Support28
 - Operator fails to start28
 - Motor operates, but gate does not move28
 - Motor sounds like it is working harder than normal28
 - Limit switch getting out of time28
 - Gate stopping part way open or closed28
 - Gate staying open with automatic system28
 - How to Order Replacement Parts28
- Model SLR Exploded View29
- Model SLC Exploded View30
- Model SLD Exploded View32
- Model SLD Maintenance34
 - Battery Maintenance34
 - DC Motor Brush Replacement34
- Preventative Maintenance35
 - General35
 - Lubrication35
 - 6-Month Preventative Maintenance35
- FCC Notice35
- Gate Operator Installation Checklist36
- Notes37







WARNING



ONLY QUALIFIED TECHNICIANS SHOULD WORK ON LINEAR SLIDE GATE OPERATORS



WARNING

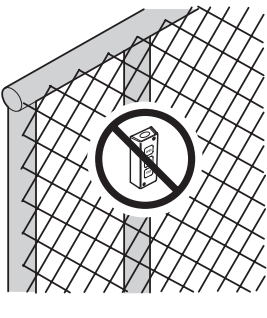

CONTROLS INTENDED FOR USER ACTIVATION MUST BE LOCATED AT LEAST SIX FEET (6') AWAY FROM ANY MOVING PART OF THE GATE AND WHERE THE USER IS PREVENTED FROM REACHING OVER, UNDER, AROUND OR THROUGH THE GATE TO OPERATE THE CONTROLS. OUTDOOR OR EASILY ACCESSIBLE CONTROLS SHALL HAVE A SECURITY FEATURE TO PREVENT UNAUTHORIZED USE.

Pre-installation Information

Before You Begin...

Before unpacking, inspect the carton for exterior damage. If you find damage, advise the delivery carrier of a potential claim. Inspect your package carefully. You can check your accessory box parts with the enclosed packing slip for your convenience. Claims for shortages will be honored for only 30 days from the date of shipment.

Before installing the operator, read this manual completely to ensure all requirements for proper installation are present. Verify that the voltage to be used matches the voltage of the operator. If you have any questions about the requirements for proper installation of this gate operator contact technical support at 800-421-1587.

Always Check the Gate's Action

It's very important before installing the gate operator to make sure the gate's slides free and level throughout the entire opening distance. If the gate does not seem to operate properly, it may affect the operator performance or greatly shorten the life of the unit. The gate should also be designed so that airflow is ample to prevent wind resistance and drag.

Gate Operator Classifications

All gate operators can be divided into one of four different classifications, depending on their design and usage. Install this gate operator only when the operator is appropriate for the construction and usage class as defined below:

- **Class I Residential Vehicular Gate Operator**
A vehicular gate operator intended for use in a home or for one to four single family dwellings with a common garage or parking area associated with these dwellings.
- **Class II Commercial / General Access Vehicular Gate Operator**
A vehicular gate operator intended for use in a commercial location or building such as a multi-family housing unit of five or more single family units, hotel, retail store or other building servicing the general public.
- **Class III Industrial / Limited Access Vehicular Gate Operator**
A vehicular gate operator intended for use in an industrial location or building such as a factory or loading dock area or other location not intended to service the general public.
- **Class IV Restricted Access Vehicular Gate Operator**
A vehicular gate operator intended for use in a guarded industrial location or building such as an airport security area or other restricted access locations not servicing the general public, in which unauthorized access is prevented via supervision by security personnel.

Approved Obstruction Detection Devices

The following contact or non-contact obstruction detection devices have been approved for use with this slide gate operator as part of a UL325 compliant installation:

- **Contact Edges**
Miller Edge Models: MGO20, MGR20, MGS20
- **Wireless Contact Adapter**
GTO Models: SGEKAC, SGEKDC, SGET, SGER
- **Obstruction Input Expansion**
Miller Edge Model: MIM-62
- **Photoeyes**
Omron Model: E3K-R10K4-NR
Miller Edge Models: RG-K-R, PG-K-R50
EMX Models: IRB-MON, IRB-RET

Safety Information and Warnings

THE FOLLOWING FORMATS ARE USED FOR SAFETY NOTES IN THESE INSTRUCTIONS.

⚠ CAUTION ⚠
This type of warning note is used to indicate the possibility of damage to the gate or gate operator.

⚠ WARNING ⚠
This type of warning note is used to indicate possible mechanical hazards that may cause serious injuries or death.

⚡ WARNING ⚡
This type of warning note is used to indicate possible electrical shock hazards that may cause serious injuries or death.

Regulatory Warnings

Read the following before beginning to install this slide gate operator:

IMPORTANT INSTALLATION SAFETY INSTRUCTIONS

⚠ WARNING ⚠

TO REDUCE THE RISK OF SEVERE INJURY OR DEATH TO PERSONS, REVIEW THESE INSTALLATION SAFETY STEPS BEFORE PROCEEDING

1. READ AND FOLLOW ALL INSTALLATION INSTRUCTIONS.
2. Read the yellow "Safety Instructions" brochure enclosed with the packet of information. If any pages are missing or are unreadable, or you do not have the safety instructions, please call Linear at 1-800-421-1587 to request additional copies.
3. ALL ELECTRICAL CONNECTIONS TO THE POWER SUPPLY MUST BE MADE BY A LICENSED ELECTRICIAN AND MUST OBSERVE ALL NATIONAL AND LOCAL ELECTRICAL CODES.
4. A separate power-disconnect switch should be located near the operator so that primary power can be turned off when necessary.
5. Install the enclosed warning signs on both sides of the gate. A minimum of two (2) WARNING SIGNS shall be installed, one on each side of the gate where easily visible.
6. Never reach between, through or around the fence to operate the gate.
7. Never connect a button station within reach of the gate or on the side of the gate operator.
8. Do not adjust the operator controller's current sensing feature too high. It should be adjusted high enough to keep the gate from falsely triggering the sensing, but no higher than necessary for the gate to operate. DO NOT DEFEAT THE PURPOSE OF THIS FUNCTION!
9. You must install all required safety equipment.
10. UL325 Compliance requires the use of contact edges or photoelectric controls on all automatic or remotely-controlled gate operators.
11. The operator is intended for installation only on gates used for vehicles. Pedestrians must be supplied with a separate access opening. The pedestrian access opening shall be designed to promote pedestrian usage. Locate the gate such that persons will not come into contact with the vehicular gate during the entire path of travel of the vehicular gate.

Wiring Specifications

Refer to the following steps for details on power and accessory wiring for the operator.



WARNING



ALL AC ELECTRICAL CONNECTIONS TO THE POWER SOURCE AND THE OPERATOR MUST BE MADE BY A LICENSED ELECTRICIAN AND MUST OBSERVE ALL NATIONAL AND LOCAL ELECTRICAL CODES.

USE COPPER WIRE ONLY!

AC Power Wiring

1. Find the listing on this page corresponding to the model, voltage and horsepower rating of your operator.
2. The distance shown in the table is measured in feet from the operator to the power source. **DO NOT EXCEED THE MAXIMUM DISTANCE.** These calculations have been based on standard 115 V and 230 V supplies with a 10% drop allowable. If your supply is under the standard rating, the runs listed may be longer than what your application will handle, and you should not run wire too near the maximum distance for the gauge of wire you are using.
3. When large-gauge wire is used, a separate junction box (not supplied) may be needed for the operator power connection.
4. Wire length calculations are based on the National Electrical Code, Article 430 and have been carefully determined based on motor inrush, brake solenoids, and operator requirements.
5. Connect power in accordance with local codes. The green ground wire must be properly connected.
6. Wire insulation must be suitable to the application.
7. Electrical outlets are supplied in all 115 VAC models for convenience with occasional use or low power consumption devices only. If you choose to run dedicated equipment from these devices, it will decrease the distance for maximum length and the charts will no longer be accurate.

DC Control and Accessory Wiring

1. **All control devices are now 24 VDC, which can be run up to 2000 feet with 14 AWG wire.**
2. Control wiring must be run in a separate conduit from power wiring. Running them together may cause interference and faulty signals in some accessories.
3. A three-wire shielded conductor cable is required to connect two operators together for dual operation. You must use Belden 8760 Twisted Pair Shielded Cable (or equivalent) only – P/N 2500-1982, per foot). See Page 25 for details of this connection. **Note: The shield wire should be connected in both the operators.**

MODEL SLR POWER WIRING			
VOLTS & HP	MAXIMUM DISTANCE (FEET)		WIRE GAUGE
	SINGLE	DUAL	
115 VOLTS 1/2-HP	316	158	12
	502	251	10
	800	400	8
	1272	636	6
	2022	1011	4
230 VOLTS 1/2-HP	764	382	12
	1218	609	10
	1936	968	8
	3076	1538	6
	4896	2448	4

MODEL SLC POWER WIRING			
VOLTS & HP	MAXIMUM DISTANCE (FEET)		WIRE GAUGE
	SINGLE	DUAL	
115 VOLTS 1/2-HP	222	111	12
	354	177	10
	566	283	8
	900	450	6
	1430	715	4
115 VOLTS 3/4-HP	178	89	12
	282	141	10
	450	255	8
	716	358	6
	1140	570	4
115 VOLTS 1-HP	160	80	12
	254	127	10
	406	203	8
	646	323	6
	1026	513	4
208 VOLTS 1/2-HP	760	380	12
	1200	600	10
	1924	962	8
	3060	1830	6
	4864	2432	4
208 VOLTS 3/4-HP	604	302	12
	958	478	10
	1526	763	8
	2424	1212	6
	3856	1928	4
208 VOLTS 1-HP	544	272	12
	864	432	10
	1374	686	8
	2184	1092	6
	3476	1738	4
230 VOLTS 1/2-HP	894	447	12
	1422	711	10
	2264	1132	8
	3600	1800	6
	5724	2862	4
230 VOLTS 3/4-HP	710	355	12
	1128	564	10
	1796	898	8
	2852	1426	6
	4538	2269	4
230 VOLTS 1-HP	640	320	12
	1016	508	10
	1616	808	8
	2570	1285	6
	4090	2045	4

MODEL SLD POWER WIRING			
VOLTS & HP	MAXIMUM DISTANCE (FEET)		WIRE GAUGE
	SINGLE	DUAL	
115 VOLTS 1/2-HP	430	215	12
	684	342	10
	1090	545	8
	1732	866	6
	2756	1378	4

Mounting Pad Installation

The gate operator mounts bolted to a custom poured concrete mounting pad. The pad supports the operator and prevents it from moving during operation.

An optional post mount kit is also available (P/N 2120-483) which allows installation without a concrete mounting pad.

Gate Preparation

Before installing the pad, make sure the gate rolls or slides freely, and that all exposed rollers are properly covered. The gate must be covered with fabric with openings no larger than 2-1/4" in size, to a minimum height of 48" above ground level. On picket-style gates, if pickets are spaced less than 2-1/4" apart, mesh is optional.

Mounting Pad Specifications

Recommended pad size is 21" x 21" minimum. Pad depth should be set according to local codes and at least as deep as frost line. 5/8" J-bolts may be set into the concrete before it sets following the dimensions shown, or drilled after the concrete sets.

⚠ WARNING ⚠
 The operator is intended for installation only on gates used for vehicles. Pedestrians must be supplied with a separate access opening. The pedestrian access opening shall be designed to promote pedestrian usage. Locate the gate such that persons will not come into contact with the vehicular gate during the entire path of travel of the vehicular gate.

⚠ WARNING ⚠
 The gate must be installed in a location so that enough clearance is supplied between the gate and adjacent structures when opening and closing to reduce the risk of entrapment. Swing gates shall not open into public areas.

⚠ WARNING ⚠
 The gate must be properly installed and work freely in both directions prior to the installation of the gate operator. Do not adjust the force setting to compensate for an improperly installed, improperly functioning, or damaged gate.

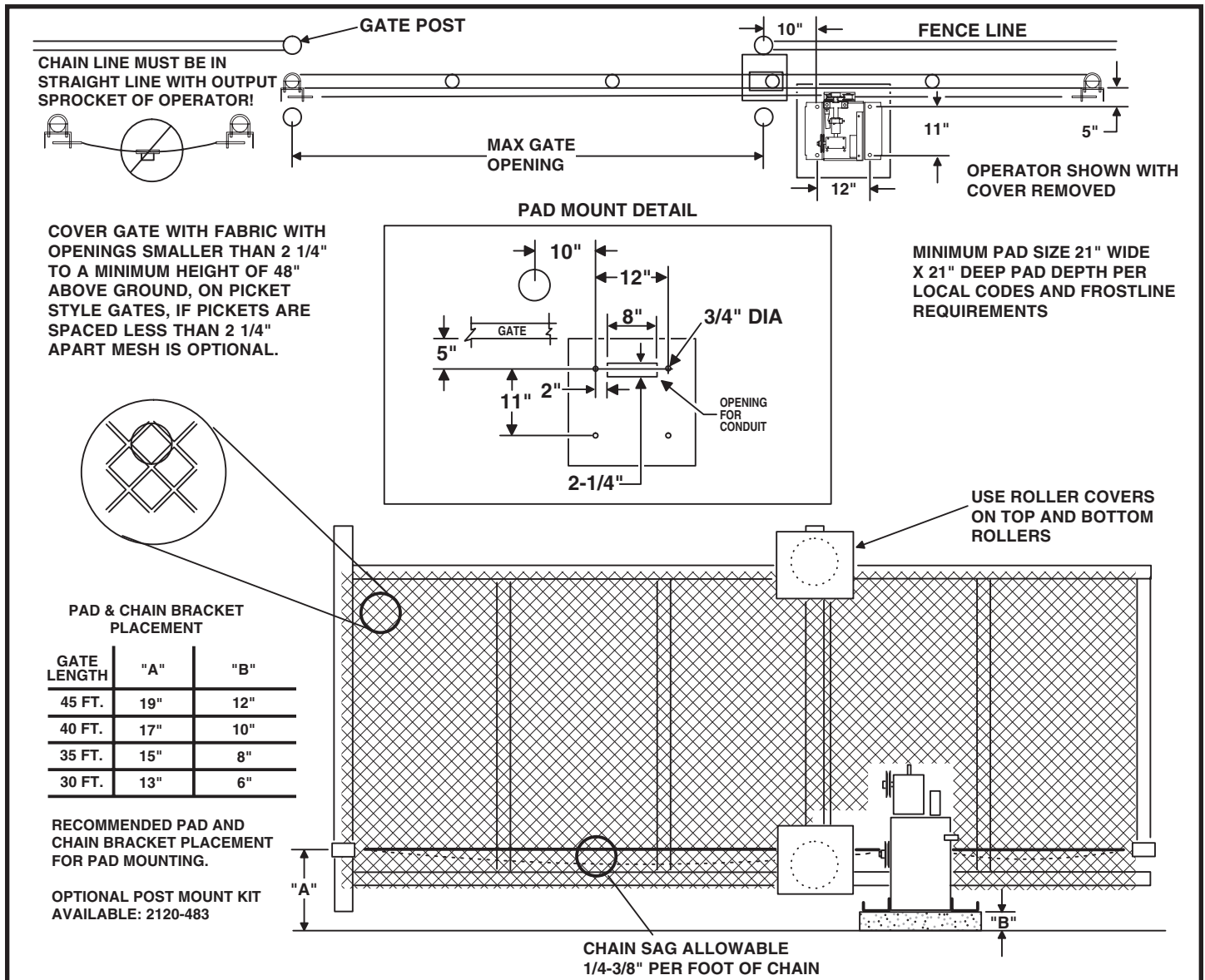

Figure 1. Mounting Pad Specifications

Gate Bracket and Chain Assembly

✓ **NOTE:** The item numbers shown in these illustrations are for reference only. For the actual part numbers, refer to the parts lists in the rear of this manual.

Assemble a gate bracket (1) to the front edge of the gate, using two U-bolts (2), and mounting hardware (3). Before tightening down completely, be sure the bracket is parallel to the gate. Tighten the U-bolt hardware the rest of the way, then screw the square head bolts (4) into the threaded holes in the gate plate until they bottom out against the gate. These will help keep the bracket from twisting on the pipe.

Slide a threaded chain pin (5) through the bracket as shown, with spring (6), flat washer (10), and two hex nuts (7). Attach one end of the drive chain (8) to the chain pin using master link (9) and begin unrolling the chain toward the operator. An optional Tail Mount configuration is shown in Figure 4B.

Remove the rain cover from the back of the slide gate operator. Carefully thread the drive chain under the first idler, over the drive sprocket, and then under the last idler. Make sure you feed most of the chain through the idlers and sprocket before attaching the chain to the back end of the gate.

Assemble the other gate bracket on the rear edge of the gate, using the same process as the front gate bracket. Once this is done, take the other chain pin, spring and jam nuts and assemble with the end of drive chain and the other master link.

At this point you should be able to adjust the chain tension by tightening the jam nuts on each end. **Approximately 1/4" to 3/8" of slack per foot of drive chain is acceptable.** Make sure the chain does not drag on the ground, across the gate rollers or the idler frame of the operator.

Additional mounting holes have been provided in the gate bracket for installer convenience.

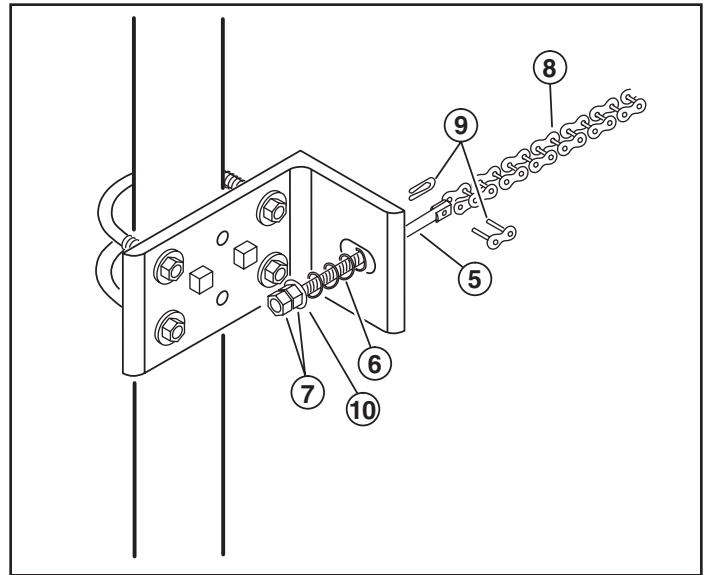

Figure 3. Chain Pin and Chain Assembly

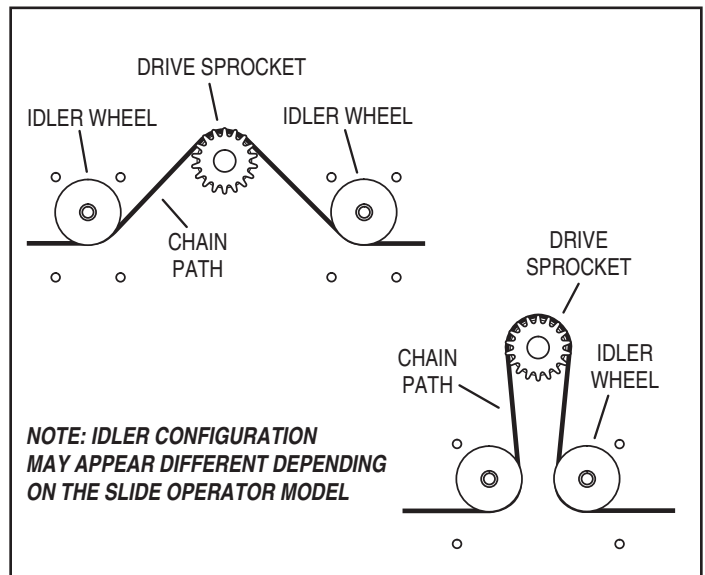

Figure 4A. Chain Path

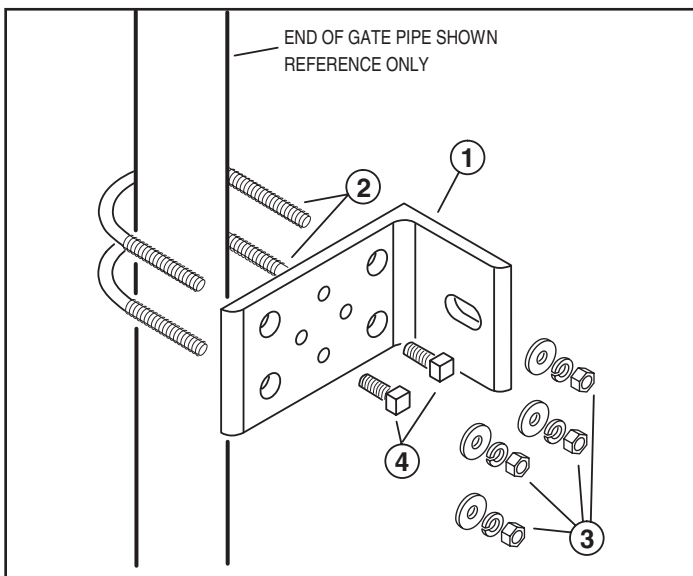

Figure 2. Mounting Gate Bracket to Gate

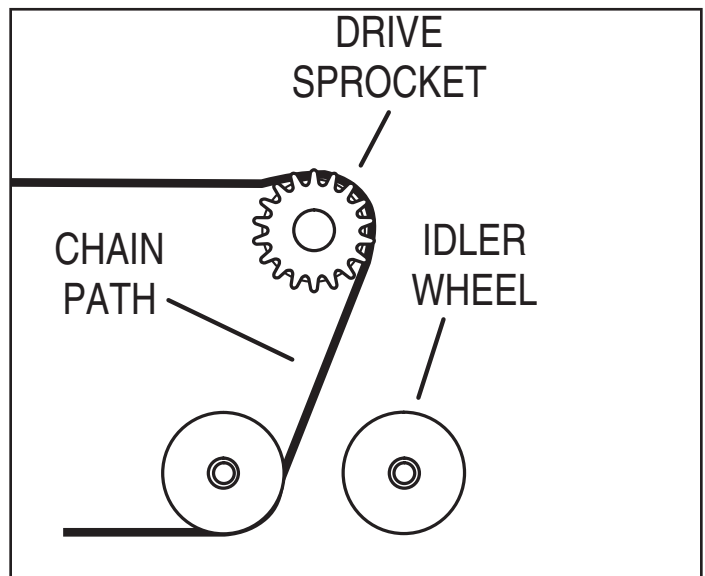

Figure 4B. Tail Mount Chain Path

Operator Preparation

Vent Plug Installation

In order to keep gear oil from spilling out during shipping, gear reducers used in this gate operator has either a solid plug, or a sealed vent plug, installed at the factory.

For operators with a solid plug, replace the solid plug with the vent plug provided (see Figure 5).

With the vent plug installed, remove the vent plug's breather pin to allow the gear box to vent (see Figure 5).

Operator Setup

Controller Access

The Controller is protected by a plastic dust cover. To remove the dust cover, loosen the cover's wing-screw and lift the cover off (see Figure 6).

⚡ WARNING ⚡

ALL AC ELECTRICAL CONNECTIONS TO THE POWER SOURCE AND THE OPERATOR MUST BE MADE BY A LICENSED ELECTRICIAN AND MUST OBSERVE ALL NATIONAL AND LOCAL ELECTRICAL CODES

AC Power Connection

All Linear gate operators are supplied with a power disconnect switch to turn on and off the power available to the operator (see Figure 7). Following wiring specifications on Page 2, incoming power should be brought into the operator and connected to the labeled pigtails from the disconnect box. A wiring connections print can also be found on the label inside the cover of the operator.

- ✓ **NOTE:** FOR SOLAR POWERED UNITS ONLY: The APeX Controller's AC power disconnect switch does not turn off the Apex DC power when connected to solar panels. It will however, disconnect DC motor power. Unplug the solar panel input on the front of the Apex Controller prior to servicing the unit.

Proper thermal protection is supplied with the operator. The motor contains a thermal overload protector to guard from overheating the motor due to overload or high-frequency operation. This overload protector will reset automatically after the motor cools down.

Earth Ground

Install a ground rod and connect it to the operator's frame in every gate operator installation. A good earth ground is necessary to allow the Controller's built-in surge and lightning protection circuitry to work effectively. The physical bolting of the operator to the mounting pad *is not* sufficient for a good earth ground.

- ✓ **NOTE:** Do not splice the ground wire. Use a single piece of solid copper 12 AWG wire between the ground rod and the operator.

1. Install an 8-foot long copper ground rod next to the operator mounting pad within three feet of the operator.
2. Use a clamp to connect a solid copper 12 AWG ground wire to the ground rod.
3. Route the ground wire to the operator.

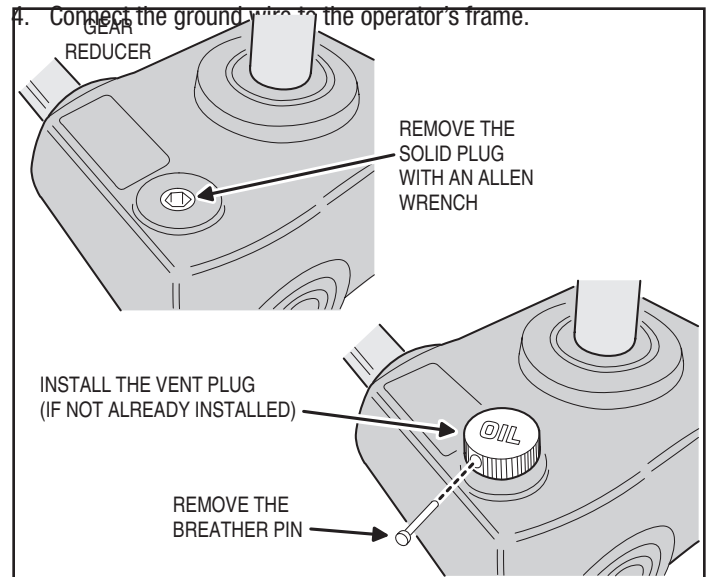

Figure 5. Vent Plug Installation

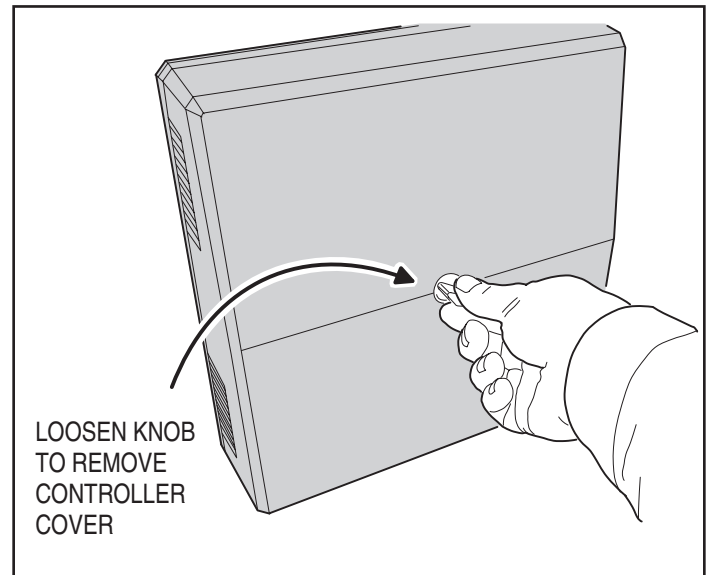

Figure 6. Controller Access

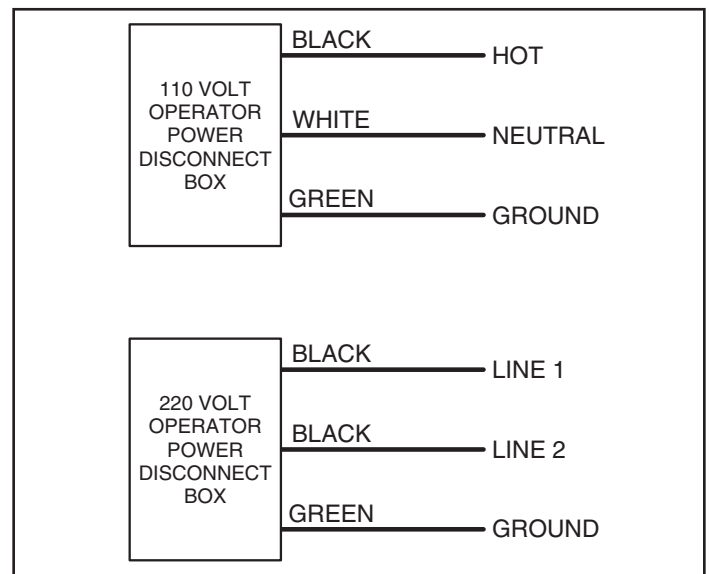

Figure 7. Power Disconnect Box Wiring

Operator Setup (Continued)

Limit Nuts Rough Adjustment

The limit nuts are not preset at the factory and must be adjusted for the length of the gate in each installation. The limit switches are activated by two threaded nylon rotary limit nuts which are attached to a threaded limit shaft driven by a chain and sprockets from the main drive shaft (see Figure 8). **REMOVE THE CARDBOARD FILLER BEFORE ADJUSTING THE LIMIT NUTS.**

The Controller is factory set for right hand installations. The left limit nut is for **OPEN** and the right limit nut is for **CLOSE**. The limit nuts flip their definition in left hand installations. (see left-right hand programming on Page 11).

1. With the gate connected to the gate operator in a mid-travel position, **the power disconnect switch turned OFF**, disconnect the operator by using the manual disconnect lever, once the operator has been disconnected, **manually** move the gate by hand to within a foot of its fully open position (the foot of distance is necessary to allow for coasting of the operator after the limit switch is tripped).
2. Once the gate is in this position, adjust the **OPEN** limit nut until it activates the limit switch for open. Press down the detent plate and rotate the nut along the threaded shaft (see Figure 9).
3. After setting the open limit, move the gate to one foot from fully closed and repeat the process for the **CLOSE** limit nut (see Figure 9).

Limit Nuts Fine Adjustment

After finishing the rough limit nut adjustments, reposition the gate to approximately the center of travel.

⚠ CAUTION ⚠

If the operator is installed in a left-hand installation. Set the Controller to left-hand operation BEFORE running the operator for the fine setting of the limit nuts. Failure to do so will result in over-shooting the limit switches, and can cause damage to the operator and/or gate. Refer to programming on Page 11.

1. Re-engage the operator using the disconnect handle.
2. Turn the power disconnect switch **ON**.
3. Stand clear of any moving parts and press the **OPEN** button.
4. After the gate opens, press the **CLOSE** button.
5. Observe the gate in both directions as it runs through each complete cycle. Adjust the open or close limit nuts again if necessary. Fine levels of adjustment can be made by adjusting a few teeth on the nut at a time. If the gate stops during travel, you may need to adjust the Open or Close Current Setting or the Maximum Run Timer (see Pages 12-13).

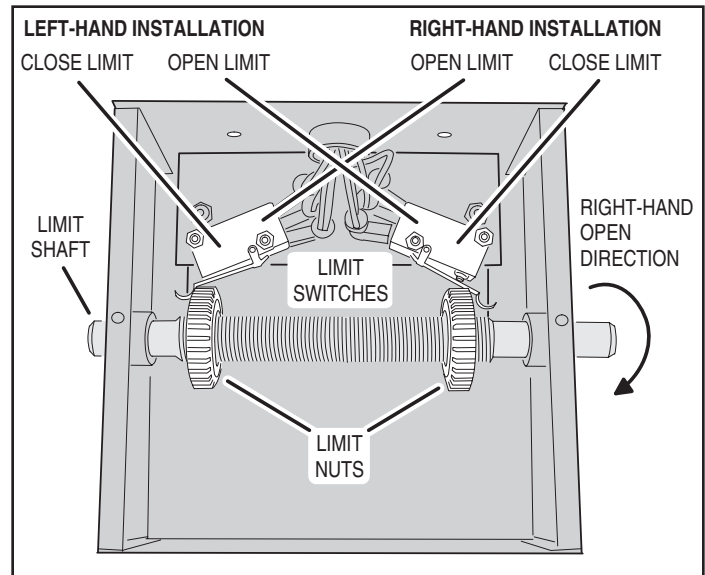

Figure 8. Limit Box Assembly

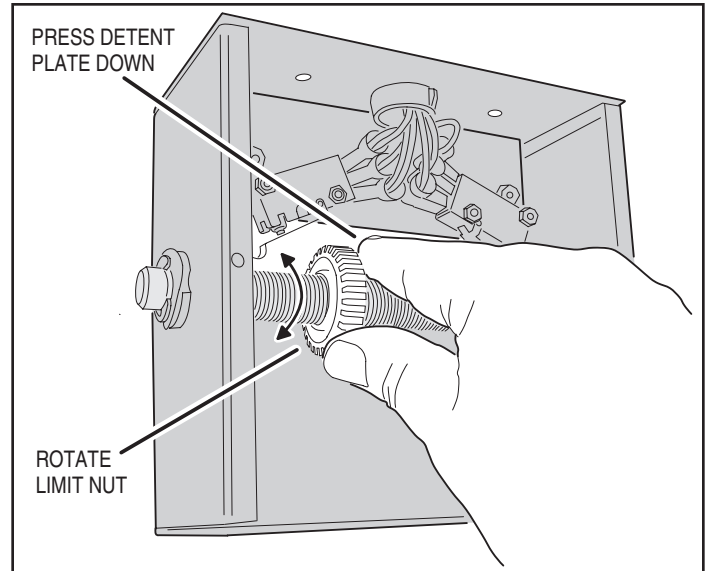

Figure 9. Setting the Limits

Controller Features

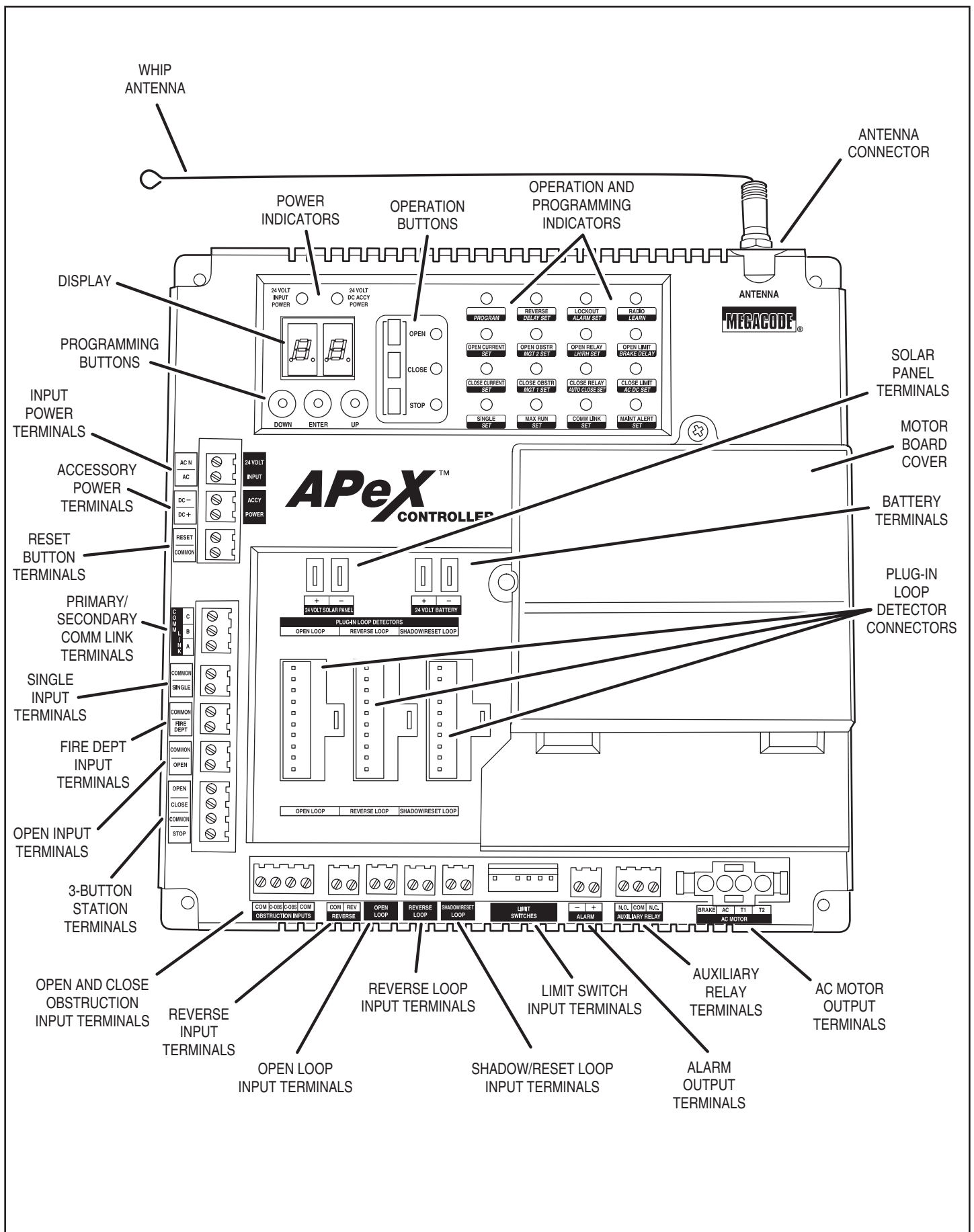































Figure 10. Controller Features

Indicator Descriptions

INDICATOR DEFINITION		INDICATION WHEN LIT DURING NORMAL OPERATION	INDICATION WHEN LIT DURING PROGRAMMING
OPERATION	PROGRAMMING		
24 VOLT INPUT POWER		LOW VOLTAGE AC POWER IS PRESENT	
24 VOLT DC ACCY POWER		LOW VOLTAGE DC POWER IS PRESENT	
OPEN		OPEN SIGNAL PRESENT FROM THE INTERNAL RECEIVER OR AN EXTERNAL DEVICE CONNECTED TO THE OPEN INPUT TERMINAL	
CLOSE		CLOSE SIGNAL IS PRESENT FROM A DEVICE CONNECTED TO THE CLOSE INPUT TERMINAL	
STOP		STOP INPUT TERMINAL IS OPEN AND NOT CONNECTED TO COMMON	
PROGRAM			CONTROLLER IS IN PROGRAMMING MODE
REVERSE	DELAY SET	SIGNAL FROM REVERSING DEVICE IS PRESENT	SET REVERSE DELAY TIME
LOCKOUT	ALARM SET	CONTROLS AND OPERATOR ARE LOCKED OUT BECAUSE OF EXISTING TROUBLE CONDITION	SET RUN ALARM AND PRE-START ALARM
RADIO	LEARN	BUILT-IN RECEIVER IS DETECTING A RADIO SIGNAL FROM A REMOTE CONTROL	TRANSMITTERS CAN BE ENTERED INTO MEMORY (UP TO 40 TRANSMITTERS)
OPEN CURRENT	SET	MOTOR CURRENT HAS EXCEEDED THE OPEN CURRENT SETTING WHILE OPENING	SET MAXIMUM OPEN CURRENT
OPEN OBSTR	MGT 2 SET	OPEN OBSTRUCTION TERMINAL CONNECTED TO COMMON BY BEAM OR SAFETY EDGE, OR SIGNAL FROM MGT OBSTACLE TRANSMITTER	SET MGT #2 FUNCTION
OPEN RELAY	LH/RH SET	OPEN RELAY IS ACTIVATED	SET LEFT-HAND RIGHT-HAND OPERATION
OPEN LIMIT	BRAKE DELAY	OPEN LIMIT SWITCH IS ACTIVATED	
CLOSE CURRENT	SET	MOTOR CURRENT HAS EXCEEDED THE CLOSE CURRENT SETTING WHILE CLOSING	SET MAXIMUM CLOSE CURRENT
CLOSE OBSTR	MGT 1 SET	CLOSE OBSTRUCTION TERMINAL CONNECTED TO COMMON BY BEAM OR SAFETY EDGE, OR SIGNAL FROM MGT OBSTACLE TRANSMITTER	SET MGT #1 FUNCTION
CLOSE RELAY	AUTO CLOSE SET	CLOSE RELAY IS ACTIVATED	SET AUTO-CLOSE TIME
CLOSE LIMIT	AC DC SET	CLOSE LIMIT SWITCH IS ACTIVATED	SET MOTOR TYPE
SINGLE	SET	SINGLE TERMINAL CONNECTED TO COMMON BY AN EXTERNAL PUSHBUTTON OR RADIO	SET SINGLE BUTTON INPUT FUNCTION
MAX RUN	SET	MAXIMUM RUN TIMER HAS BEEN EXCEEDED	SET MAXIMUM RUN TIME
COMM LINK	SET	DUAL OPERATOR CONNECTION DETECTED, BLINKS IF CONNECTION HAS FAILED	
MAINT ALERT	SET	MAINTENANCE IS REQUIRED ON OPERATOR	SET MAINTENANCE ALERT CYCLE COUNT

APEX FUNCTION DISPLAY INDICATIONS

 "RL" LEFT OR RIGHT HAND OPERATION	 "SB" SINGLE BUTTON INPUT SETUP	 "LP" LOW POWER MODE	 "MO" MOTOR TYPE SELECTION
 "PM" SINGLE OR DUAL GATE	 "SM" STAGGER MODE	 "FS" POWER FAILURE MODE	 "RA" RADIO ENABLE
 "AC" AUTO CLOSE TIMER	 "ST" STAGGER TIME	 "SS" SOFT START/STOP DURATION	 "TL" LEARN TRANSMITTERS
 "RP" RUN ALARM PRE-START ALARM	 "AR" AUXILIARY RELAY MODE	 "CT" RESET CYCLE COUNT	 "TD" DELETE TRANSMITTERS
 "OC" MAXIMUM OPEN CURRENT	 "RD" REVERSE DELAY TIME	 "MA" MAINTENANCE ALERT TRIGGER	 "ML" LEARN MGT TRANSMITTERS
 "CC" MAXIMUM CLOSE CURRENT	 "CP" CONSTANT PRESSURE MODE	 "MT" MID-TRAVEL STOP POSITION	 "MD" ERASE MGT TRANSMITTERS
 "AD" ADVANCED PROGRAMMING	 "SP" SHADOW LOOP OPEN INHIBIT	 "AT" ANTI-TAILGATE ENABLE	 "CL" RESET TO FACTORY DEFAULTS
 "RT" MAXIMUM RUN TIMER			

Terminal Descriptions

TERMINAL	GROUP	FUNCTION
AC N AC	24 VOLT INPUT	FACTORY CONNECTED TO 24 VAC FROM TRANSFORMER OR 24 VDC FROM CONTINUOUS DUTY DC SUPPLY.
DC - DC +	ACCESSORY POWER	PROVIDES 24 VOLT DC POWER FOR ACCESSORIES. (.5A MAX)
RESET COMMON	RESET BUTTON	FACTORY CONNECTED TO THE CONTROLLER'S RESET BUTTON.
C B A	COMM LINK	FOR 3-WIRE NETWORK CONNECTION TO SECOND OPERATOR IN DUAL GATE INSTALLATIONS.
COMMON SINGLE	SINGLE BUTTON INPUT	CONNECT TO NORMALLY OPEN SWITCH FOR SINGLE BUTTON OPERATION. ALTERNATES BETWEEN OPEN-CLOSE OR OPEN-STOP-CLOSE DEPENDING ON PROGRAMMING.
COMMON FIRE DEPT	FIRE BOX INPUT	CONNECT TO NORMALLY OPEN SWITCH IN FIRE BOX FOR FIRE DEPARTMENT ACCESS.
COMMON OPEN	OPEN INPUT	CONNECT TO NORMALLY OPEN DEVICES (KEYPAD, CARD READER, KEYSWITCH, TELEPHONE ENTRY SYSTEM) TO OPEN THE GATE. A CONSTANT OPEN INPUT WILL OVERRIDE THE MID-TRAVEL STOP AND HALT THE AUTO CLOSE TIMER UNTIL RELEASED.
OPEN CLOSE COMMON STOP	3-BUTTON STATION INPUT	CONNECT TO 3-BUTTON STATION FOR OPEN-CLOSE-STOP CONTROL. A CONSTANT OPEN INPUT WILL OVERRIDE THE MID-TRAVEL STOP AND HALT THE AUTO CLOSE TIMER UNTIL RELEASED.
COM O-OBS	OPEN OBSTRUCTION INPUT	CONNECT TO APPROVED OBSTRUCTION DETECTION DEVICES (GATE EDGE, PHOTO BEAM) TO DETECT AN OBSTRUCTION DURING OPENING. WHILE GATE IS MOVING, ANY OPEN OBSTRUCTION SIGNAL WILL CAUSE THE GATE TO STOP, REVERSE A SHORT DISTANCE, AND THEN STOP AGAIN. AT THIS TIME THE AUTO CLOSE TIMER IS DISABLED, AND A RENEWED INPUT WILL BE REQUIRED TO START THE GATE AGAIN. SHOULD THE GATE BE RESTARTED AND THE OBSTACLE SIGNAL OCCUR AGAIN PRIOR TO REACHING A LIMIT, THE GATE WILL STOP AGAIN, LOCKOUT, AND SOUND THE CONTINUOUS TONE ALARM.
C-OBS COM	CLOSE OBSTRUCTION INPUT	CONNECT TO APPROVED OBSTRUCTION DETECTION DEVICES (GATE EDGE, PHOTO BEAM) TO DETECT AN OBSTRUCTION DURING CLOSING. WHILE GATE IS MOVING, ANY CLOSE OBSTRUCTION SIGNAL WILL CAUSE THE GATE TO STOP, THEN REVERSE AND TRAVEL TO THE FULL OPEN POSITION. SHOULD A OPEN OBSTRUCTION INPUT OR AN OPEN DIRECTION INHERENT ENTRAPMENT CONDITION OCCUR PRIOR TO THE GATE REACHING THE OPEN LIMIT, THE OPERATOR WILL LOCKOUT AND SOUND THE CONTINUOUS TONE ALARM. IF THE AUTO CLOSE TIMER IS SET, WHEN THE CLOSE OBSTRUCTION INPUT IS CLEARED, THE GATE WILL CLOSE WHEN THE AUTO CLOSE TIMER EXPIRES.
COM REV	REVERSE	CONNECT TO NORMALLY OPEN DEVICES TO CAUSE A REVERSAL WHEN THE GATE IS TRAVELING CLOSED. THE GATE WILL REVERSE TO THE FULL OPEN POSITION.
OPEN LOOP OPEN LOOP	OPEN LOOP	CONNECT TO OPEN LOOP/FREE EXIT LOOP. THE GATE WILL OPEN WHEN THE LOOP IS TRIGGERED, AND REMAIN OPEN AS LONG AS THE LOOP IS TRIGGERED. REQUIRES LOOP DETECTOR.
REVERSE LOOP REVERSE LOOP	REVERSE LOOP	CONNECT TO REVERSE LOOP. TRIGGERING THE LOOP WILL CAUSE A REVERSAL WHEN THE GATE IS TRAVELING CLOSED. THE GATE WILL REVERSE TO THE FULL OPEN POSITION. REQUIRES LOOP DETECTOR.
SHADOW/RESET LOOP SHADOW/RESET LOOP	SHADOW/RESET LOOP	CONNECT TO SHADOW/RESET LOOP TO KEEP THE GATE IN ITS FULLY OPEN POSITION AS LONG AS THE SIGNAL IS PRESENT. USED TO KEEP GATE OPEN WHILE VEHICLE IS PASSING THROUGH. REQUIRES LOOP DETECTOR.
- +	ALARM	FACTORY CONNECTED TO THE ALARM BEEPER.
N.O. COM N.C.	AUX RELAY	FOR CONNECTION TO AUXILIARY DEVICES (MAGNETIC LOCK, SOLENOID LOCK, STROBE LIGHT) FOR ACTIVATION (OR DEACTIVATION) DURING GATE OPERATION.
+ -	24 VOLT SOLAR PANEL	FOR CONNECTION TO 24 VOLT SOLAR PANEL FOR BATTERY CHARGING.
+ -	24 VOLT BATTERY	FACTORY CONNECTED TO BATTERIES IN DC MODEL OPERATORS.

Operator Accessory Connections

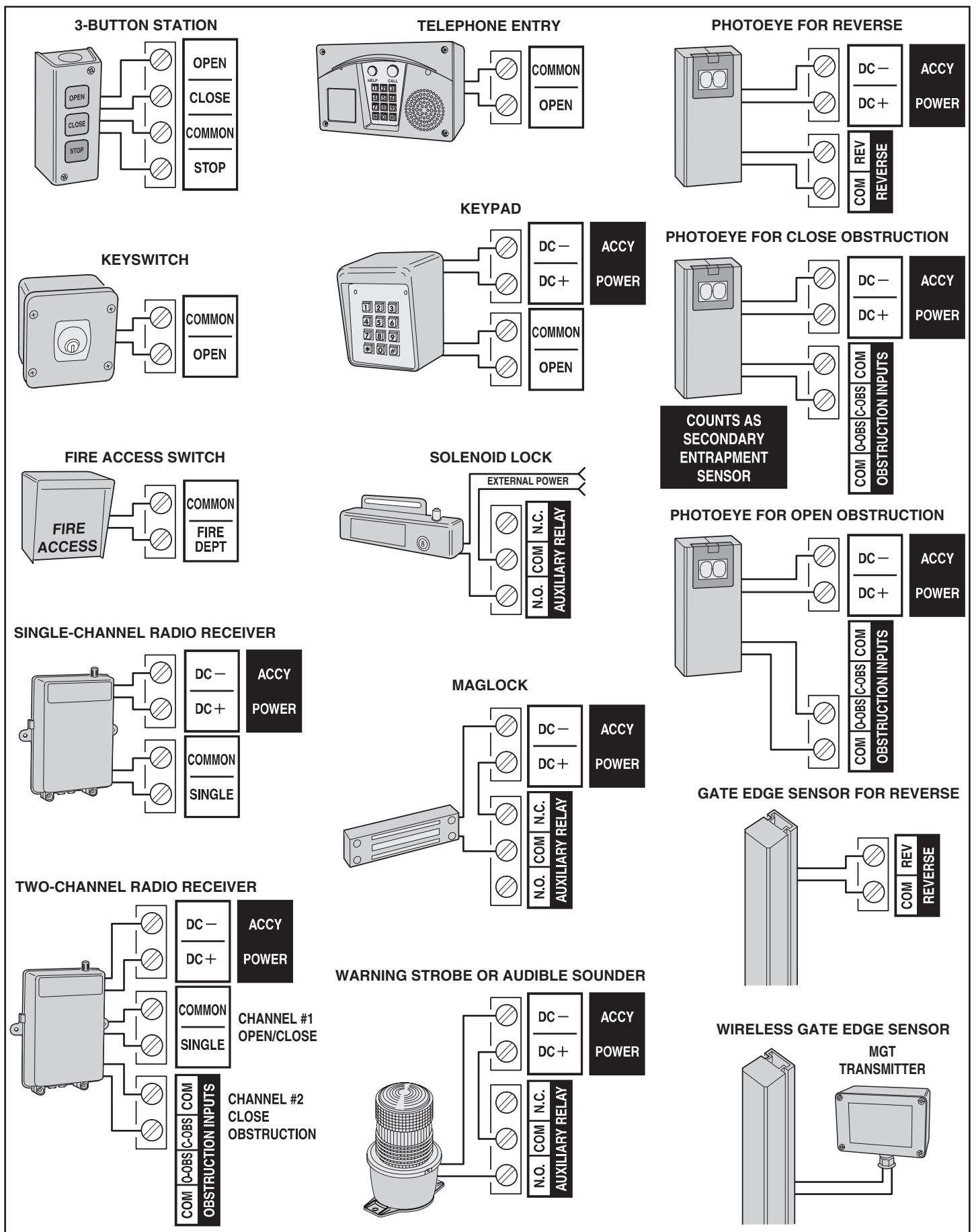

Figure 11. Operator Accessory Connections

Basic Controller Programming

Programming Overview

The Controller can be programmed with various options for the operator. The programming fields are defined as “functions” that have “options”. To make setup easier for the installer, the Controller’s programming is divided into two groups: basic and advanced. The basic programming group contains the functions commonly used in most slide gate installations. The advanced programming group contains functions less commonly used (i.e. dual gate stagger delay, maximum run timer, etc.).

Entering Programming Mode

Enter programming mode by pressing the **UP** and **DOWN** buttons together for one second. While in programming mode the **PROGRAM** indicator will light.

Exiting Programming Mode

Exit programming mode at any time by pressing the **UP** and **DOWN** buttons together. The Controller will automatically exit programming mode after three minutes of inactivity.

Programming Keystrokes

(Typical Programming Method)

While in programming mode, press the **UP** or **DOWN** buttons to scroll through the programming functions. When the desired function is displayed press the **ENTER** button to display the currently set option for the function. **When an option is displayed, the decimal points are lit.**

To change the option, press and hold the **ENTER** button for 1 second. To indicate that an option is ready to be changed, the display will flash. While the display is flashing, press the **UP** or **DOWN** button to display the other options available for that function.

When the desired option is displayed, press the **ENTER** button to store it into memory. To select another function, press **ENTER, UP,** or **DOWN.**

Left or Right Hand Operation

The factory default is for right hand operation (operator on right side of the driveway when viewed from the inside of the gate). For left hand installations, program the Controller for left hand operation.

Dual Gate Enable

The factory default is for single gate operation. For dual gate operation, wire the two gate controllers together through the **COMM LINK** terminals (see Page 25) and enable dual gate operation with this programming step.

✓ **NOTE:** The Mid-travel Stop feature is disabled when dual gate operation is enabled for paired units.

Auto Close Timer

The factory default turns off the Auto Close Timer. The timer can be set from 1 to 59 seconds and from 1 to 9 minutes. When the Auto Close Timer is set, after opening, the gate will wait for the length of the Auto Close Timer then close automatically.

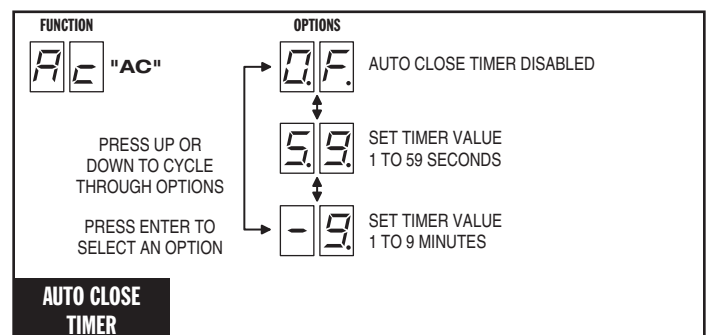
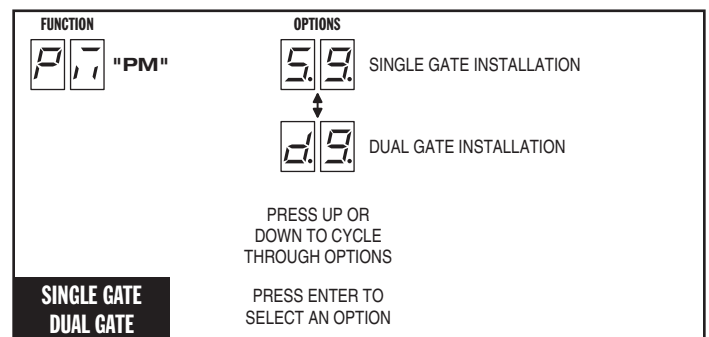
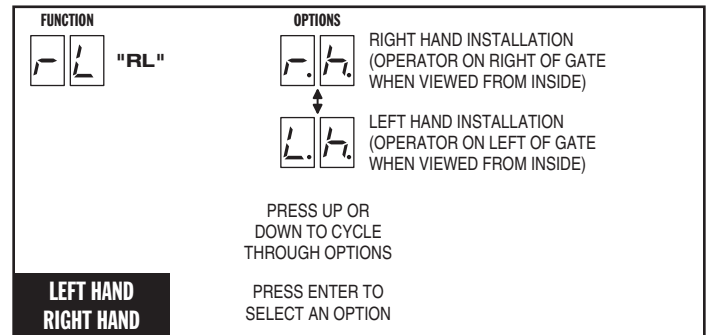
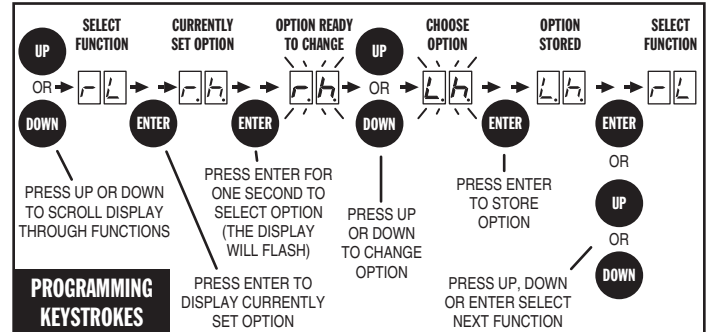
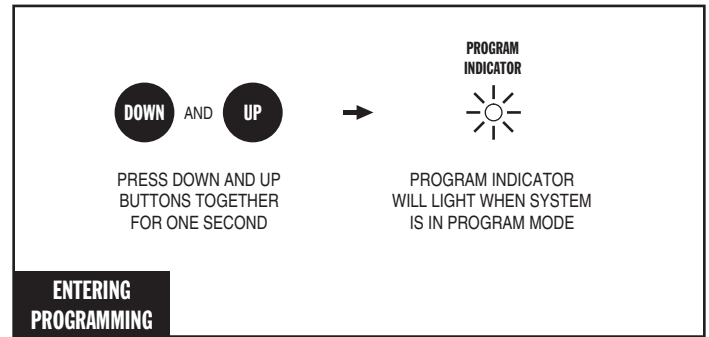

Basic Controller Programming (Cont.)

Run Alarm and Pre-start Alarm

The factory default is Run Alarm on and a 3-second Pre-start Alarm. The operator's beeper will sound 3 seconds before the operator starts. The options are:

- Run Alarm Off and Pre-start Alarm Off
- Run Alarm On and Pre-start Alarm Off
- Run Alarm On and Pre-start Alarm On for 1-9 Seconds

Maximum Open Direction Current Setting

To detect obstacles or mechanical problems with the gate, the operator monitors its motor current. If the open current load increases by more than the programmed maximum load range number, the operator will stop, reverse a short distance, then stop again. The Auto Close Timer will be disabled, and another open request will be required to start the operator again. If after restart, the overload or an open obstacle happens again before the open limit is reached, the operator will lockout and sound the alarm.

The maximum load range number may be adjusted by pressing and holding the "enter" button until the previously set number flashes.

Using the + and - buttons, set the programmed range number so that a minimal force (50-75 lbs.) will activate a reversal should an obstruction occur, but high enough to keep the gate moving under normal conditions without interruption.

Maximum Close Direction Current Setting

To detect obstacles or mechanical problems with the gate, the operator monitors its motor current. If the close current load increases by more than the programmed maximum load range number, the operator will stop, reverse, and travel to the full open position. Should an open obstruction input or an open direction inherent entrapment condition occur prior to the gate reaching the open limit, the operator will lockout and sound the continuous tone alarm. Another close request will be required to start the operator again. If after restart, the overload or a close obstacle happens again before the close limit is reached, the operator will lockout and sound the alarm. If the auto close timer is set, when the close obstruction input is cleared, the gate will close when the auto close timer expires.

The maximum load range number may be adjusted by pressing and holding the "enter" button until the previously set number flashes.

Using the + and - buttons, set the programmed range number so that a minimal force (50-75 lbs.) will activate a reversal should an obstruction occur, but high enough to keep the gate moving under normal conditions without interruption.

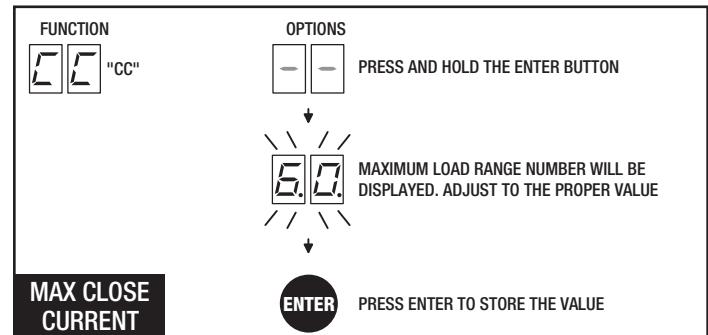
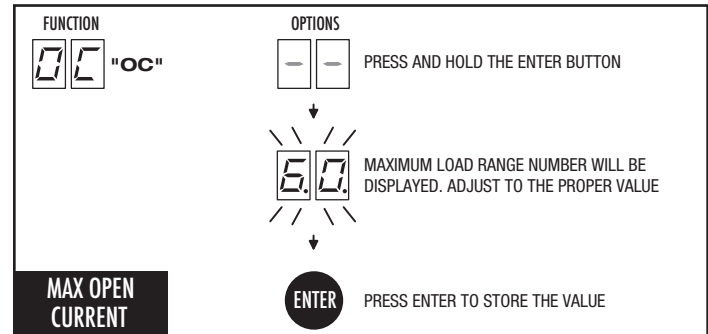
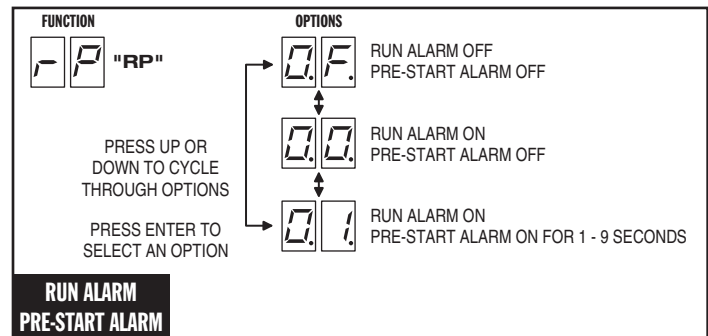

Advanced Controller Programming

Entering Advanced Programming Mode

To access and program the Advanced Programming functions, for each programming session, Advanced Programming must be enabled.

After exiting programming, the Advanced Programming functions will be available on the programming display during the next programming session unless the operator has run 50 or more cycles. After that, Advanced Programming must be enabled again.

Maximum Run Time

The factory default for the Maximum Run Time (MRT) is 99 seconds. When the operator starts, a timer will begin counting. If a open or close limit is not reached or an obstacle or reversing input is not received before the timer expires, the operator will stop, the unit locks out and the alarm sounds. The timer can be set for 10 to 99 seconds, but should be left at 99 in most applications. Setting it too close to the actual run time may cause the time to expire with changing ambient temperature, gate conditions, etc...

If AC is present and an open or close limit is not reached or an obstacle or reversing input is not received before this timer exceeds MRT, the operator will stop, the unit locks out and the alarm sounds.

In the case that AC is not present and MRT expires, it will be ignored as long as the actual run time is under 99 seconds. When the gate reached full open or full close position, MRT will be interpreted as fail safe/secure. EN05 will occur. If FS as set to fail safe, the gate will open. If FS is set to fail secure, the gate will close. However, if the actual run time is higher than 99, it will be interpreted as a physical mechanical problem, EN01 will occur and the gate will stop immediately.

Single Button Input Setup

This function is used for selecting the operation for single button controls and radio receivers.

The factory default sets the **SINGLE** input terminal so successive inputs will cycle the operator in OPEN-STOP-CLOSE-STOP order.

Alternately, the **SINGLE** input can be set to cause the gate to OPEN unless the gate is fully open. If the gate is fully open, the input will cause the gate to CLOSE.

Stagger Mode

(Rarely used in slide gate installations)

This function is used in dual gate installations only. The factory default sets the Stagger Mode to OFF. In dual gate installations the two operators communicate through the 3-wire **COMM LINK** interface. When using the Stagger Mode, set one operator for delayed opening and the other operator for delayed closing. The Stagger Delay Time programming function (see below) sets the length of the delay.

✓ **NOTE:** This function will only be displayed if dual gate operation is selected.

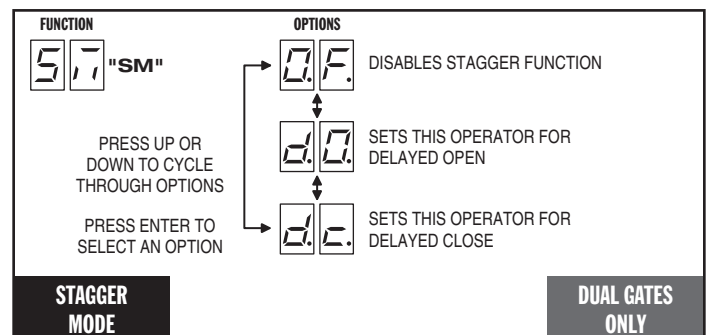
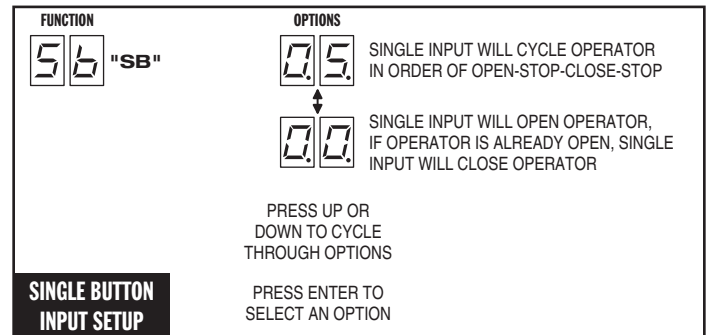
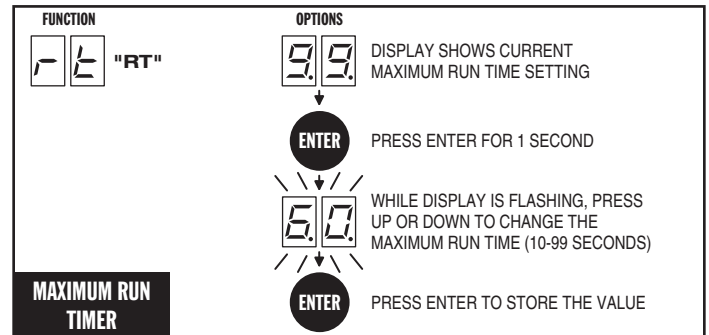
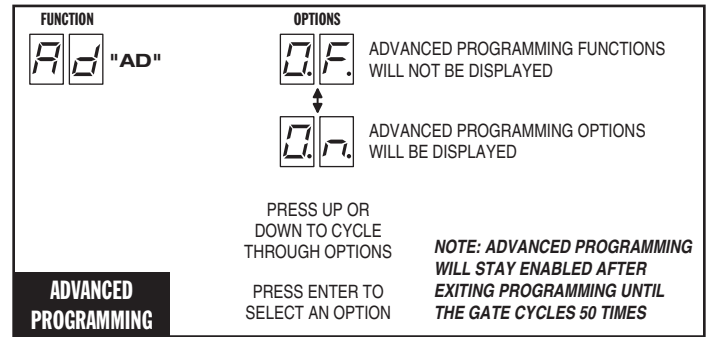

Advanced Controller Programming (Cont.)

Stagger Delay Time

(Rarely used in slide gate installations)

This function is used in dual gate installations only. The factory default sets the Stagger Time to 0 seconds (OFF). The Stagger Time sets the delay for the Stagger Mode. The Stagger Time can be set from 1-99 seconds.

✓ **NOTE:** This function will only be displayed if dual gate operation is selected.

This should be left at 99 seconds in most instances. Setting it close to the actual run time may cause the timer to expire with changing temperature, gate conditions, etc...

Auxiliary Relay Mode

The Auxiliary Relay has normally open and normally closed contacts. The factory setting disables the Auxiliary Relay. The relay can be set for:

- **Maglock:** To deactivate a magnetic or solenoid gate lock, the relay will energize during any pending or actual gate motion (open only).
- **M4:** To deactivate a magnetic or solenoid gate lock, the relay will energize during any pending or actual gate motion (open only). 3 seconds after the gate starts to move, the relay will de-energize. This option is used for higher current solenoid locks.
- **Ticket Dispenser:** The relay will energize while the gate is moving in the open direction and at the full open limit, or in an entrapment condition.
- **Strobe:** To activate a warning strobe light, the relay will energize during any pending or actual gate motion (either open or close).
- **Alarm:** The relay will energize if the gate is manually forced open from the full closed position.

Reverse Delay Time

The factory default sets the Reverse Delay to 1 second. The operator will wait the length of the delay before reversing direction. This feature will not change the reversal time when the operator is responding to an entrapment condition from an obstruction input or inherent entrapment protection sensor. The Reverse Delay can be set from 1 to 9 seconds. Heaver gates require a longer delay to allow time for the gate to stop.

Constant Pressure Mode

The factory default allows momentary pressure on a control station's **OPEN** or **CLOSE** button to cycle the operator. The controller can be set to require constant pressure on the **OPEN**, **CLOSE**, or both buttons to run the operator.

✓ **NOTE:** If a button is set for constant pressure, and it is released before the operator reaches the open or close limit, the operator will stop the gate at its current position.

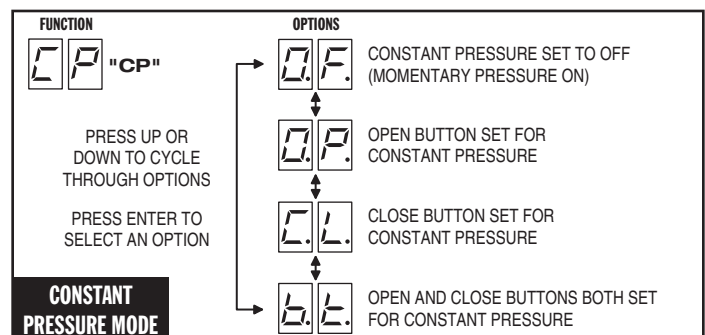
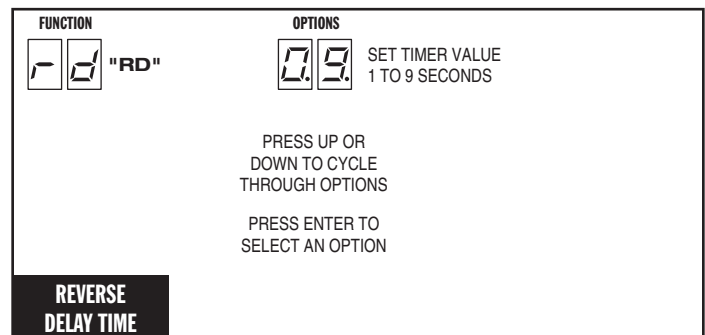
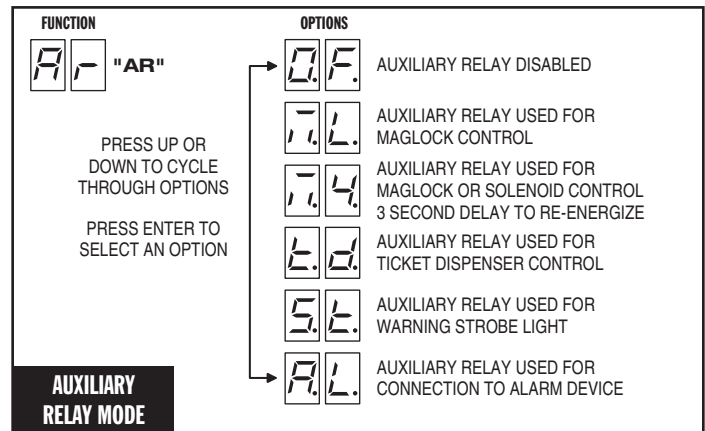
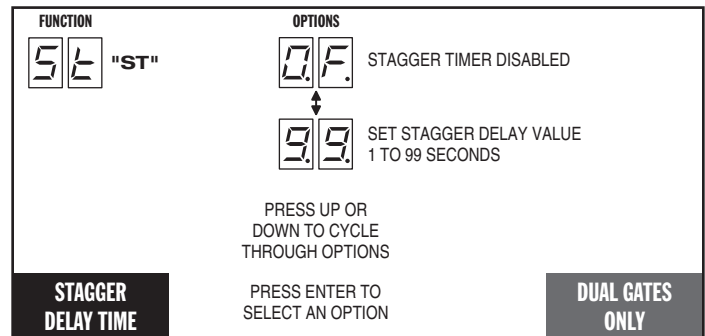

Advanced Controller Programming (Cont.)

Shadow Loop Open Prevention

If the shadow loop is triggered, it always prevents the gate from *closing* if the Auto Close Timer activates or a CLOSE command is given while the gate is at the full open position.

The controller can also be set to prevent the gate from *opening* if the shadow loop is triggered while the gate is at the close limit position. This prevents a swing gate from opening into a vehicle if it's parked near the gate on the inside.

Low Power Mode

This function is only used with DC slide gate Model SLD. The factory default disables the Low Power Mode. When Low Power Mode is enabled, and AC power fails, the controller will assume Low Power Mode after 60 seconds of gate inactivity. Low power mode turns off all accessory power and indicators. Only inputs from the radio receiver, reverse loop, open loop (optional by programming), fire department input, or restoring AC power will wake the Controller from Low Power Mode. Programming Mode can still be accessed while the Controller is awake in Low Power Mode.

✓ **NOTE:** This function will only be displayed in Model SLD operators.

Power Failure Mode

This function is only used with DC slide gate Model SLD. The factory default is set for Fail Safe, alternately the Controller can be set for Fail Secure, Open Immediate, or Close Immediate.

- **Fail Safe:** If the AC power fails and the battery voltage drops below approximately 22 Volts, 5 seconds later the operator will cycle open if not already open. When AC power is restored, or the battery gets charged by solar panels, the operator will resume normal operation and auto-close if programmed to do so.
 - **Fail Secure:** If the AC power fails and the battery voltage drops below approximately 22 Volts, 5 seconds later the operator will cycle closed if not already closed. When AC power is restored, or the battery gets charged by solar panels, the operator will resume normal operation.
- ✓ **NOTE:** Fail Safe and Fail Secure are disabled if Stagger Mode is enabled.
- **Open Immediate:** If the AC power fails, the operator will cycle open if not already open and cease operation. When AC power is restored, the operator will resume normal operation and auto-close if programmed to do so.
 - **Close Immediate:** If the AC power fails, the operator will cycle closed if not already closed and cease operation. When AC power is restored, the operator will resume normal operation.

✓ **NOTE:** This function will only be displayed in Model SLD operators.

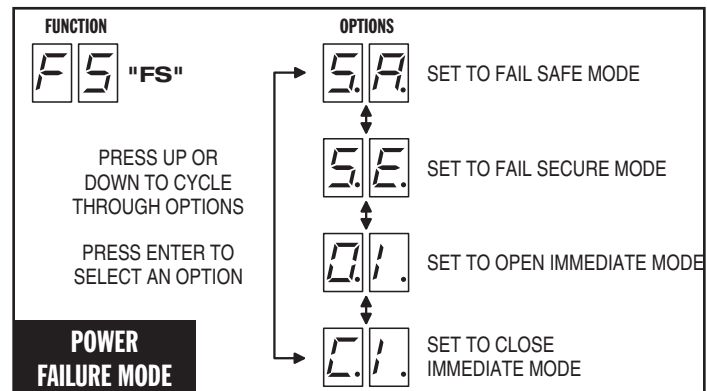
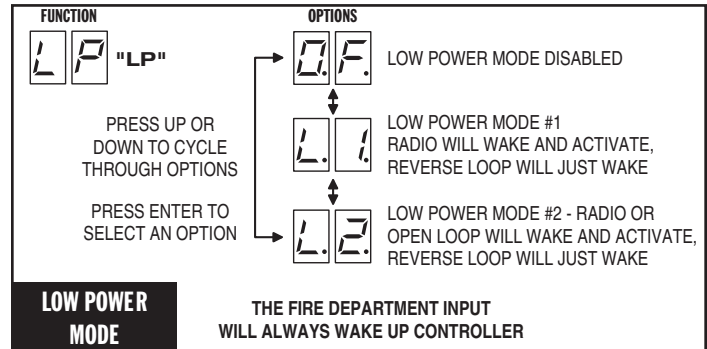
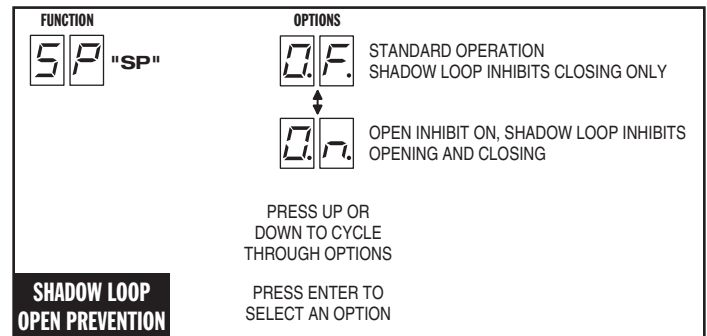

Advanced Controller Programming (Cont.)

Soft Start/Stop Duration

This function is only used with DC slide gate Model SLD. This function causes the operator to start and stop the DC motor slowly reducing gate wear and tear (at the full open or closed positions only). The factory default sets the Soft Start/Stop Duration to 3 seconds. The Soft Start/Stop Duration can be set from 1 to 10 seconds.

- ✓ **NOTE:** Changing the Soft Start/Stop Duration will reset the open and close current setting value to zero. It will be necessary to reprogram maximum open and close current settings.
- ✓ **NOTE:** This function will only be displayed in Model SLD operators set for DC motor operation with soft start motor selection.

Reset Cycle Count

The Controller counts of the number of times the operator has been cycled full open and close. The cycle count can be displayed. The display will scroll the cycle count number, flashing two digits at a time from left to right.

To reset the Cycle Count, press and hold the **ENTER** button for 2 seconds while the Cycle Count is displayed.

If the Maintenance Alert has been triggered, resetting the Cycle Count will also reset the Maintenance Alert indicator.

Maintenance Alert Trigger

The Controller has a **MAINT ALERT** indicator that can be programmed to light when the number of activations exceeds a set number of cycles.

The factory default sets the Maintenance Alert Trigger to 10,000 cycles. The Maintenance Alert Trigger can be programmed for 5, 10, 15, or 25 thousand cycles.

The Maintenance Cycle Count can be reset independently from the operator's absolute Cycle Count.

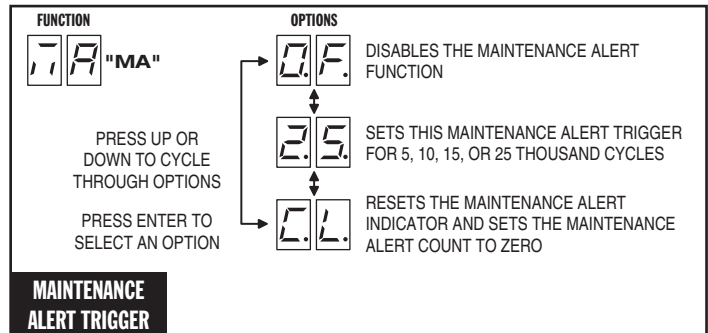
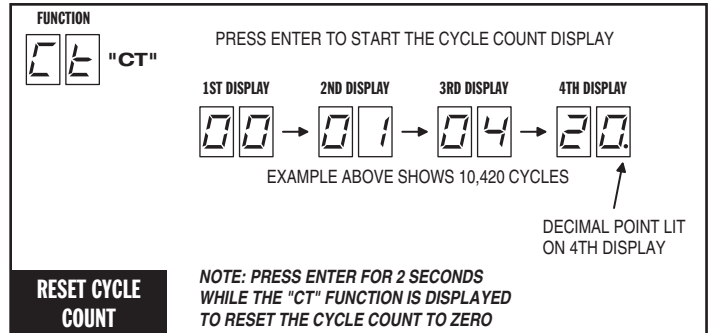
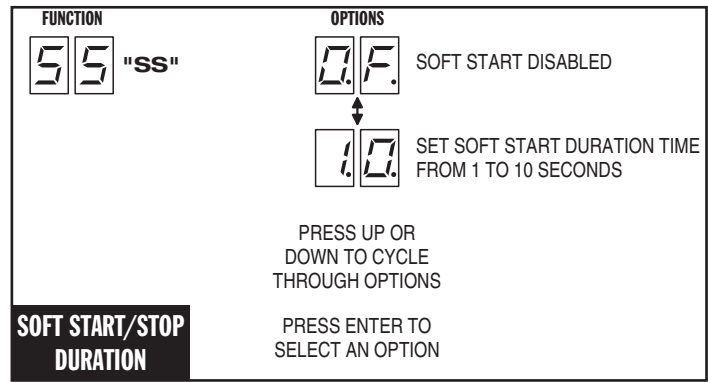

Advanced Controller Programming (Cont.)

Mid-travel Stop Position

The Controller can be programmed so the gate will stop at a mid-travel point instead of fully opening. This can be useful in installations where a large gate, that takes a long time to open and close fully, only needs to be opened partway to allow traffic to pass.

The factory default sets the Controller for full open operation. Alternately, the Controller can be programmed to open for 1 to 99 seconds then stop, before reaching the open limit.

When a Mid-travel Stop Position time has been programmed, the gate will **still fully open** if the Fire Department input is triggered, if the **OPEN** button is held down beyond the Mid-travel Stop Position, or a close obstruction or reverse loop input is triggered.

✓ **NOTE:** The Mid-travel Stop feature is disabled when dual gate operation is enabled for paired units.

Anti-tailgate Enable

The factory default sets the Anti-tailgate Enable to OFF. With this setting, during a gate cycle, after the shadow loop has been triggered by the vehicle and then has cleared after the vehicle passes, the Auto Close Timer or a CLOSE command is required to begin closing the gate.

If the Anti-tailgate Enable is set to ON, the gate will close immediately as soon as the shadow loop has cleared. Any subsequent shadow loop triggers while the gate is closing will stop the gate. When the shadow loop clears, the gate will continue closing.

Motor Type Selection

The factory sets the default for the Controller to match the type of motor in the operator. If required, change the motor selection option to a different type of motor used in the operator. The options available are:

- AC Motor Only
- DC Motor Only with Mechanical Braking
- DC Motor with Electronic Soft Start/Stop
- 3 Phase AC Motor
- AC Motor with DC Motor Backup with Mechanical Braking
- AC Motor with DC Motor Backup with Electronic Soft Start/Stop

FUNCTION	OPTIONS
"MT"	MID-TRAVEL STOP DISABLED (GATE RUNS FULL TRAVEL)
	SET LENGTH OF OPENING TIME FROM 1 TO 99 SECONDS
	PRESS UP OR DOWN TO CYCLE THROUGH OPTIONS
MID-TRAVEL STOP POSITION	PRESS ENTER TO SELECT AN OPTION

FUNCTION	OPTIONS
"AT"	ANTI-TAILGATE ENABLE OFF GATE REQUIRES AUTO OR MANUAL CLOSE
	ANTI-TAILGATE ENABLE ON GATE CLOSING WHEN SHADOW LOOP CLEARS
	PRESS UP OR DOWN TO CYCLE THROUGH OPTIONS
ANTI-TAILGATE ENABLE	PRESS ENTER TO SELECT AN OPTION

FUNCTION	OPTIONS
"MO"	AC MOTOR ONLY
	DC MOTOR ONLY WITH BRAKING
	DC MOTOR WITH SOFT START/STOP
	3 PHASE AC MOTOR
	AC MOTOR PRIMARY WITH DC MOTOR BACKUP WITH BRAKING
	AC MOTOR PRIMARY WITH DC MOTOR BACKUP WITH SOFT START/STOP
	PRESS UP OR DOWN TO CYCLE THROUGH OPTIONS
	PRESS ENTER TO SELECT AN OPTION
MOTOR TYPE SELECTION	NOTE: SELECTION MUST MATCH MOTOR BOARD!

Advanced Controller Programming (Cont.)

Radio Enable

The Controller contains a built-in MegaCode® radio receiver to allow activation from up to 40 access control transmitters and two Model MGT (gate edge) transmitters. The factory default enables the internal radio receiver. Alternately, the internal receiver can be disabled.

Antenna Installation

The Controller is supplied with a local whip antenna installed. If using a remote antenna, remove the whip antenna and connect coax cable from the antenna to the **ANTENNA** connector.

Radio Transmitter Learn

The Controller's built-in MegaCode® radio receiver can store the IDs of up to 40 transmitters. Refer to the figure for the steps required to learn transmitters.

- ✓ **NOTE:** This function will NOT be displayed if the transmitter memory is full, or if the radio receiver is disabled.

Radio Transmitter Delete

Transmitters can be deleted from the Controller's memory either individually, or all at the same time. Refer to the figure for the steps required to delete transmitters.

- ✓ **NOTE:** This function will NOT be displayed if no transmitters are stored in memory, or if the radio receiver is disabled.

MGT Obstacle Transmitter Learn

The Controller supports one or two Model MGT Obstacle Transmitters. The transmitters can be programmed to function as Open Obstruction, Close Obstruction, Reverse, or Stop. Refer to the figure for the steps required to learn MGT transmitters.

- ✓ **NOTE:** This function will NOT be displayed if two MGT transmitters are already stored in memory, or if the radio receiver is disabled.

MGT Obstacle Transmitter Delete

MGT transmitters can be deleted from the Controller's memory either individually, or all at the same time. Refer to the figure for the steps required to delete MGT transmitters.

- ✓ **NOTE:** This function will NOT be displayed if no MGT transmitters are stored in memory, or if the radio receiver is disabled.

Reset Controller to Factory Defaults

The Controller can be reset with this function. **ALL PROGRAMMED DATA WILL BE LOST**, and the factory defaults will be loaded. This function will not erase radio transmitters, current sense values, or motor type. Transmitters must be deleted with the two functions above.

FUNCTION

 "CL"

ENTER WHILE "CL" IS DISPLAYED, PRESS ENTER

ALL PROGRAMMED DATA WILL BE CLEARED AND THE FACTORY DEFAULTS WILL BE STORED IN MEMORY.

NOTE: THIS FUNCTION WILL NOT ERASE TRANSMITTERS, CURRENT SENSE VALUES, OR MOTOR TYPE.

RESET TO FACTORY DEFAULTS

FUNCTION

 "RA"

OPTIONS

 INTERNAL RADIO RECEIVER DISABLED

↕

 INTERNAL RADIO RECEIVER ENABLED

PRESS UP OR DOWN TO CYCLE THROUGH OPTIONS

PRESS ENTER TO SELECT AN OPTION

RADIO ENABLE

FUNCTION

 "TL"

ENTER PRESS ENTER (ONCE FOR EACH TRANSMITTER, UP TO 40 TRANSMITTERS TOTAL)

 "TL" WILL BLINK FOR 30 SECONDS WHILE THE CONTROLLER IS READY TO LEARN A TRANSMITTER

 ACTIVATE THE TRANSMITTER

 DISPLAY WILL SHOW "-." THEN THE TRANSMITTER ID NUMBER - IF TRANSMITTER IS ALREADY ENTERED, "dU" WILL BE DISPLAYED, IF DECODE IS BAD "ERROR" WILL BE DISPLAYED

LEARN TRANSMITTERS

FUNCTION

 "TD"

ENTER PRESS ENTER

 "TD" WILL BLINK FOR 30 SECONDS WHILE THE CONTROLLER IS READY TO DELETE ONE OR MORE TRANSMITTERS, (TO EXIT WITHOUT DELETING ANY, PRESS ENTER)

ENTER TO DELETE ALL TRANSMITTERS, PRESS ENTER FOR 2 SECONDS, OR TO PICK TRANSMITTERS GO TO NEXT STEP

UP OR DOWN PRESS UP OR DOWN TO SCROLL THROUGH THE LIST OF TRANSMITTER ID NUMBERS

 THE TRANSMITTER ID NUMBER IS DISPLAYED (TO EXIT WITHOUT DELETING, PRESS ENTER) (TO PICK A DIFFERENT TRANSMITTER ID, PRESS UP OR DOWN)

ENTER PRESS ENTER FOR 2 SECONDS TO DELETE THE TRANSMITTER DISPLAYED

DELETE TRANSMITTERS

FUNCTION

 "ML"

ENTER PRESS ENTER, "ML" WILL BLINK FOR 30 SECONDS WHILE THE CONTROLLER IS READY TO LEARN AN MGT TRANSMITTER

 ACTIVATE THE MGT TRANSMITTER, THE DISPLAY WILL FLASH "E" - IF THE TRANSMITTER IS ALREADY ENTERED, "dU" WILL BE DISPLAYED, IF DECODE IS BAD "ERROR" WILL BE DISPLAYED

UP OR DOWN PRESS UP OR DOWN TO SELECT THE MGT FUNCTION:
"E" = REVERSE "S" = STOP
"OP" = OPEN OBSTRUCTION "CL" = CLOSE OBSTRUCTION

ENTER PRESS ENTER TO ACCEPT THE SELECTION

 DISPLAY WILL SHOW "-." FOR 5 SECONDS, THEN SHOW THE TRANSMITTER'S ID NUMBER - REPEAT STEPS FOR SECOND MGT TRANSMITTER IF USED

LEARN MGT TRANSMITTERS

FUNCTION

 "MD"

ENTER PRESS ENTER

 "MD" WILL BLINK FOR 30 SECONDS WHILE THE CONTROLLER IS READY TO DELETE ALL MGT TRANSMITTERS

ENTER TO DELETE ALL MGT TRANSMITTERS, PRESS ENTER FOR 2 SECONDS, (TO EXIT WITHOUT DELETING ANY, QUICKLY PRESS ENTER)

 THE DISPLAY WILL SHOW "DELETE ALL" AND THE CONTROLLER RETURNS TO PROGRAMMING MODE

ERASE MGT TRANSMITTERS

Loop Layout Illustration

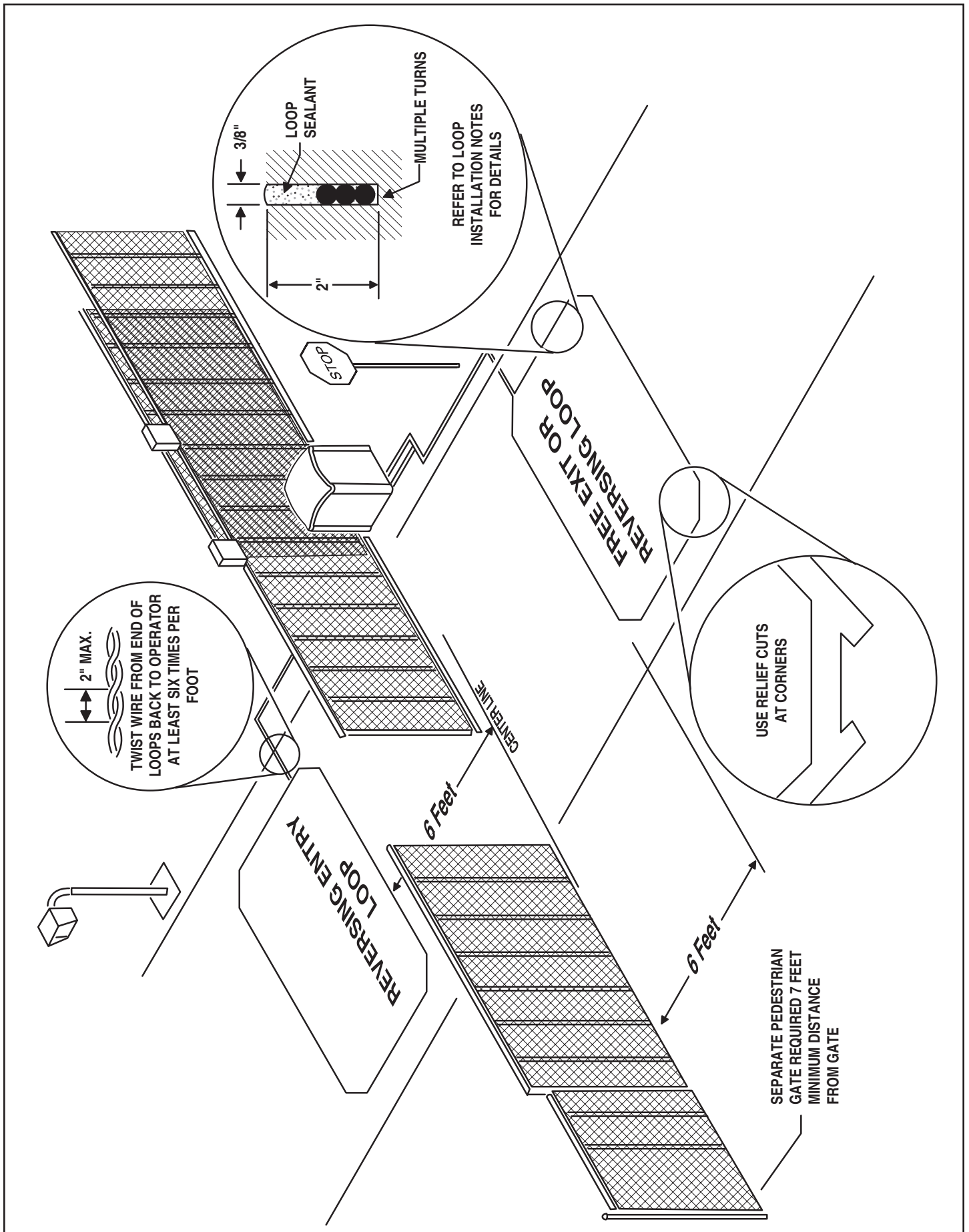

Safety Edge Layout Illustration #1

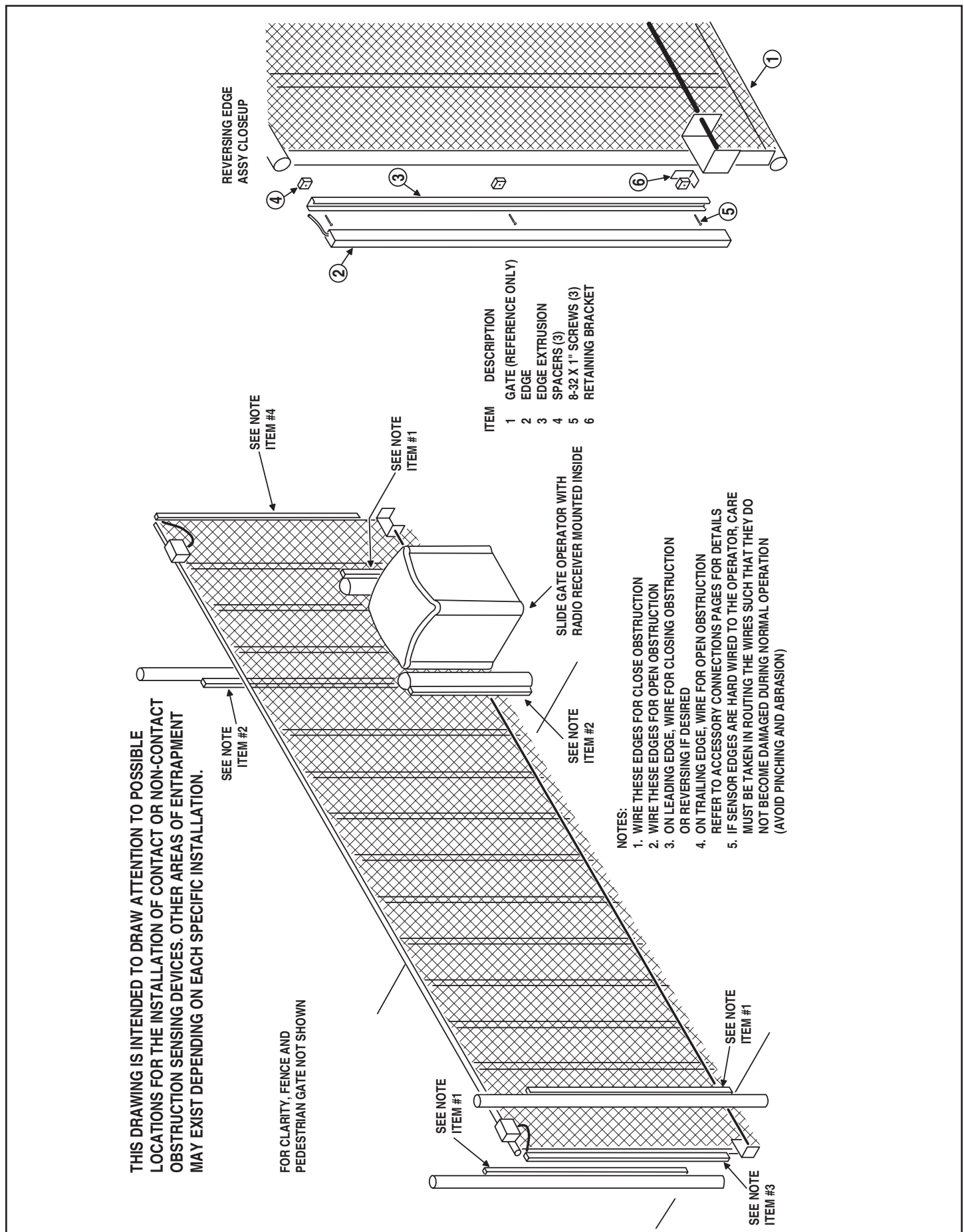

Safety Edge Layout Illustration #2

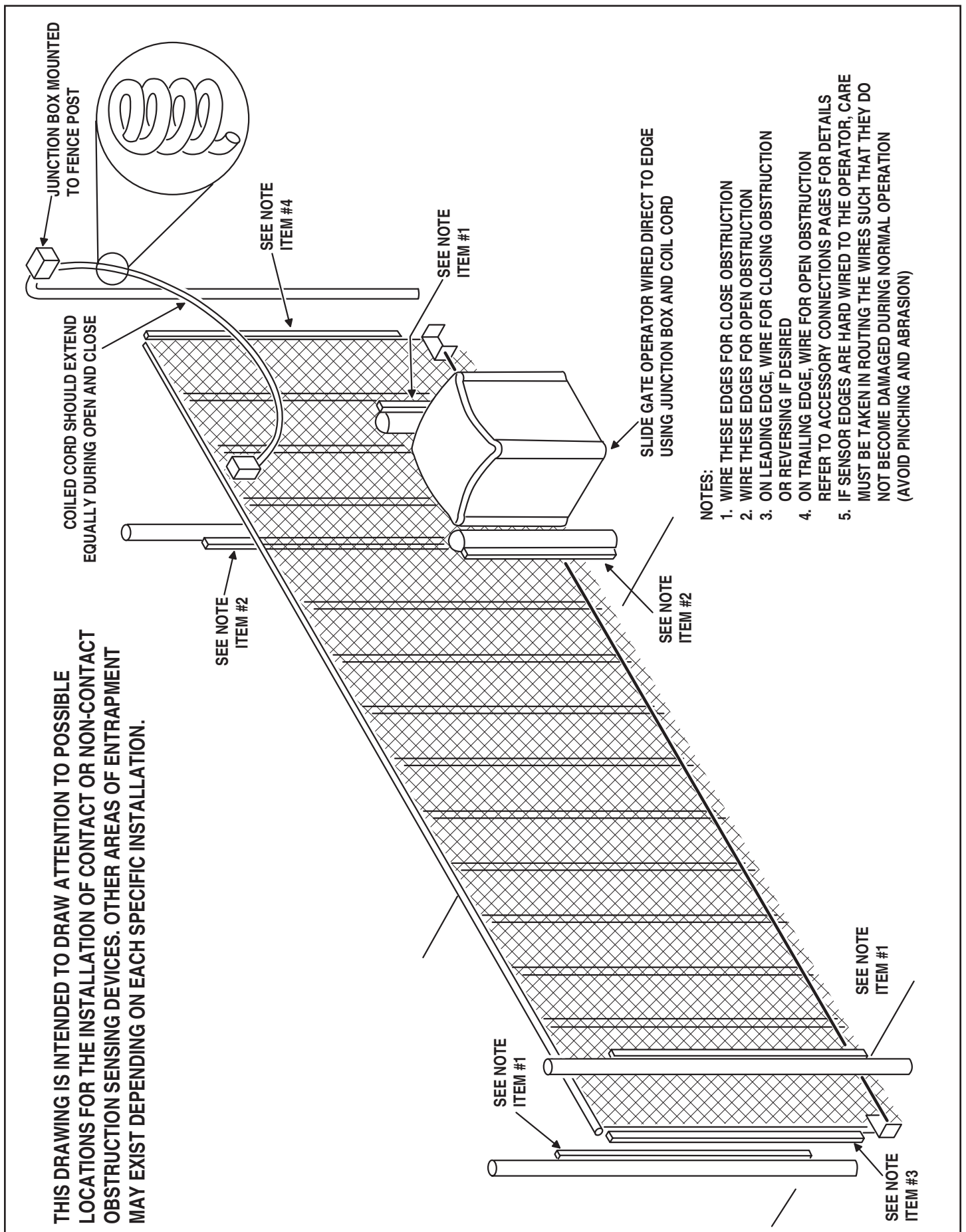

Photoeye Installation Illustration

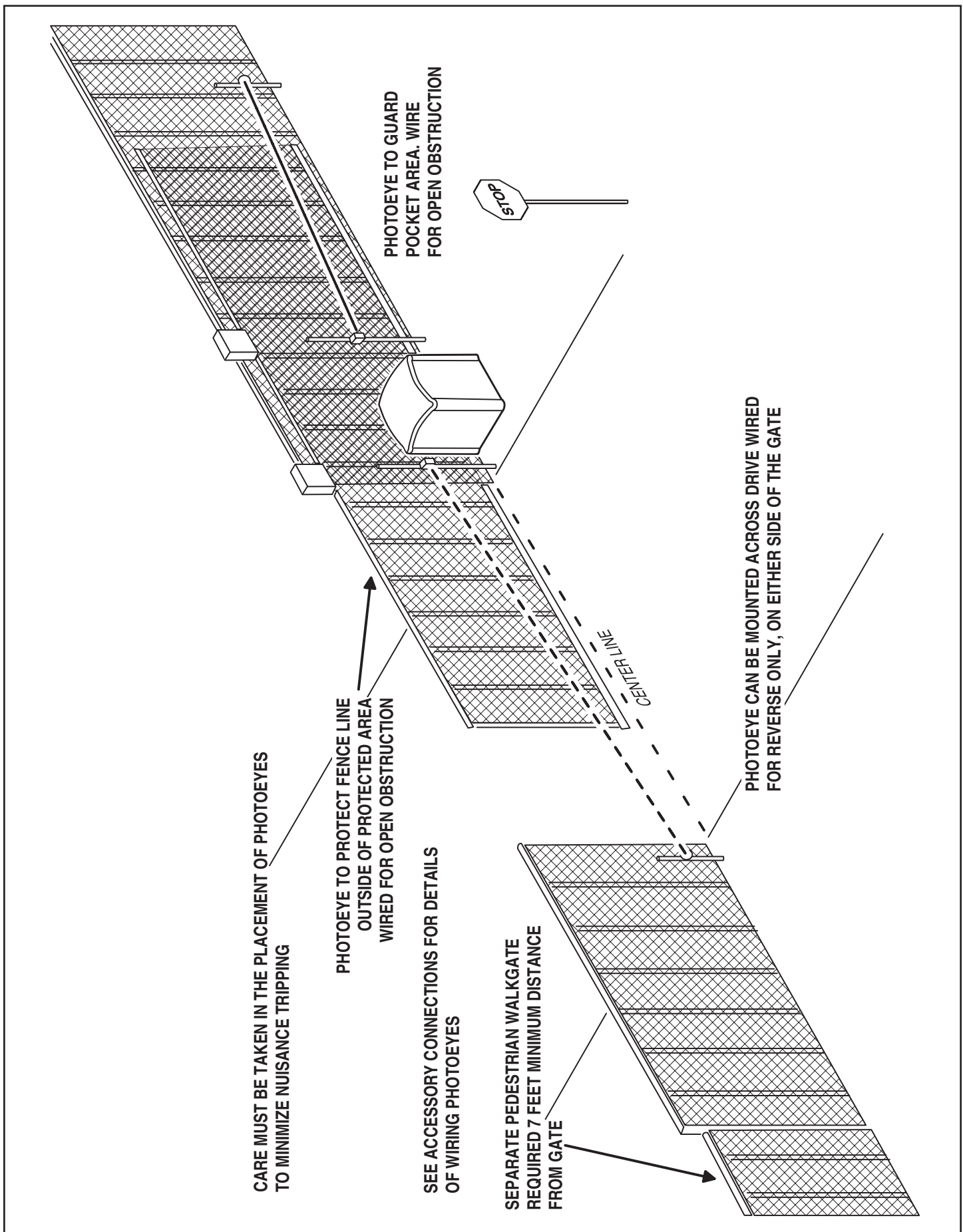

Picket Gate Installation

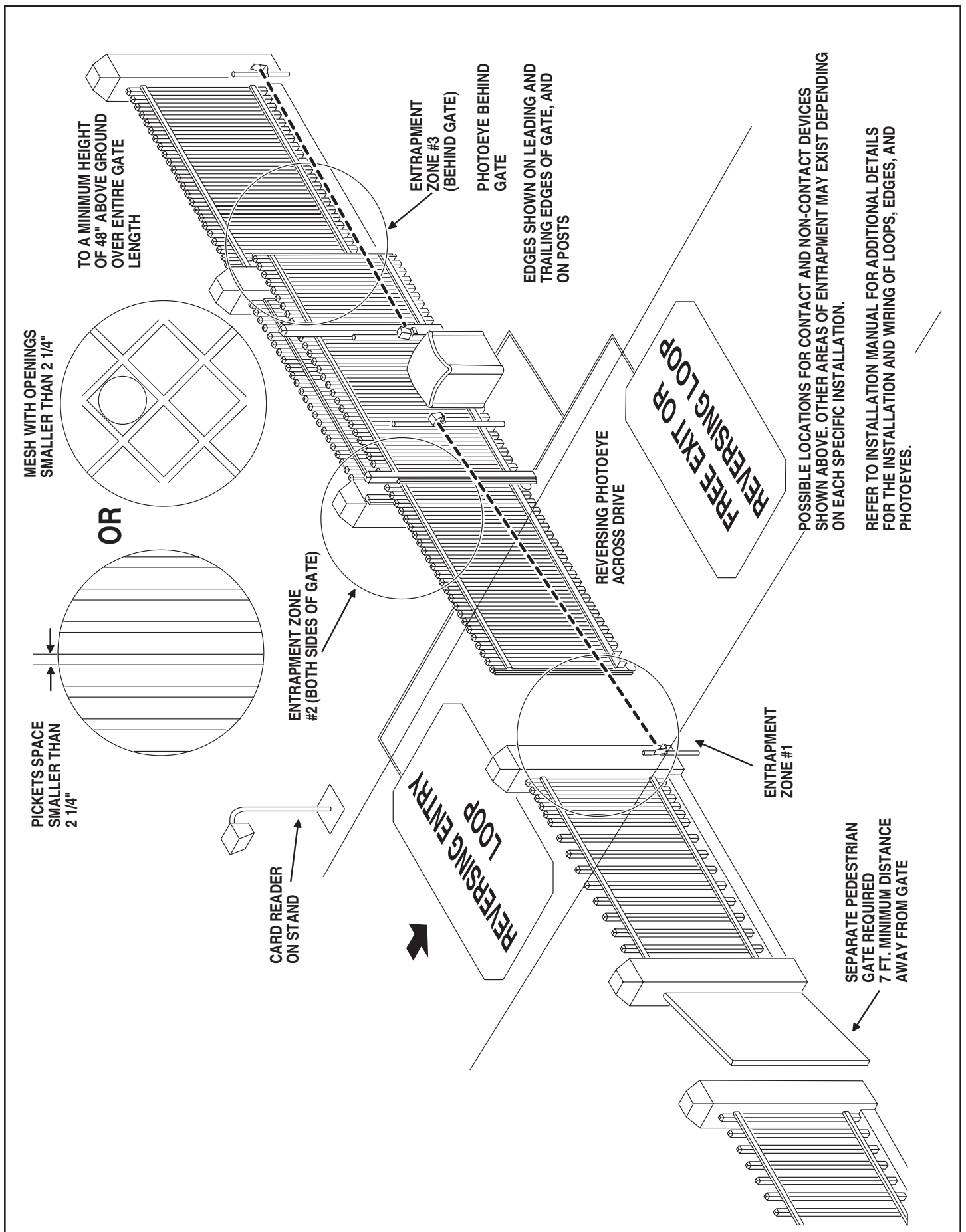

Track Gate Installation

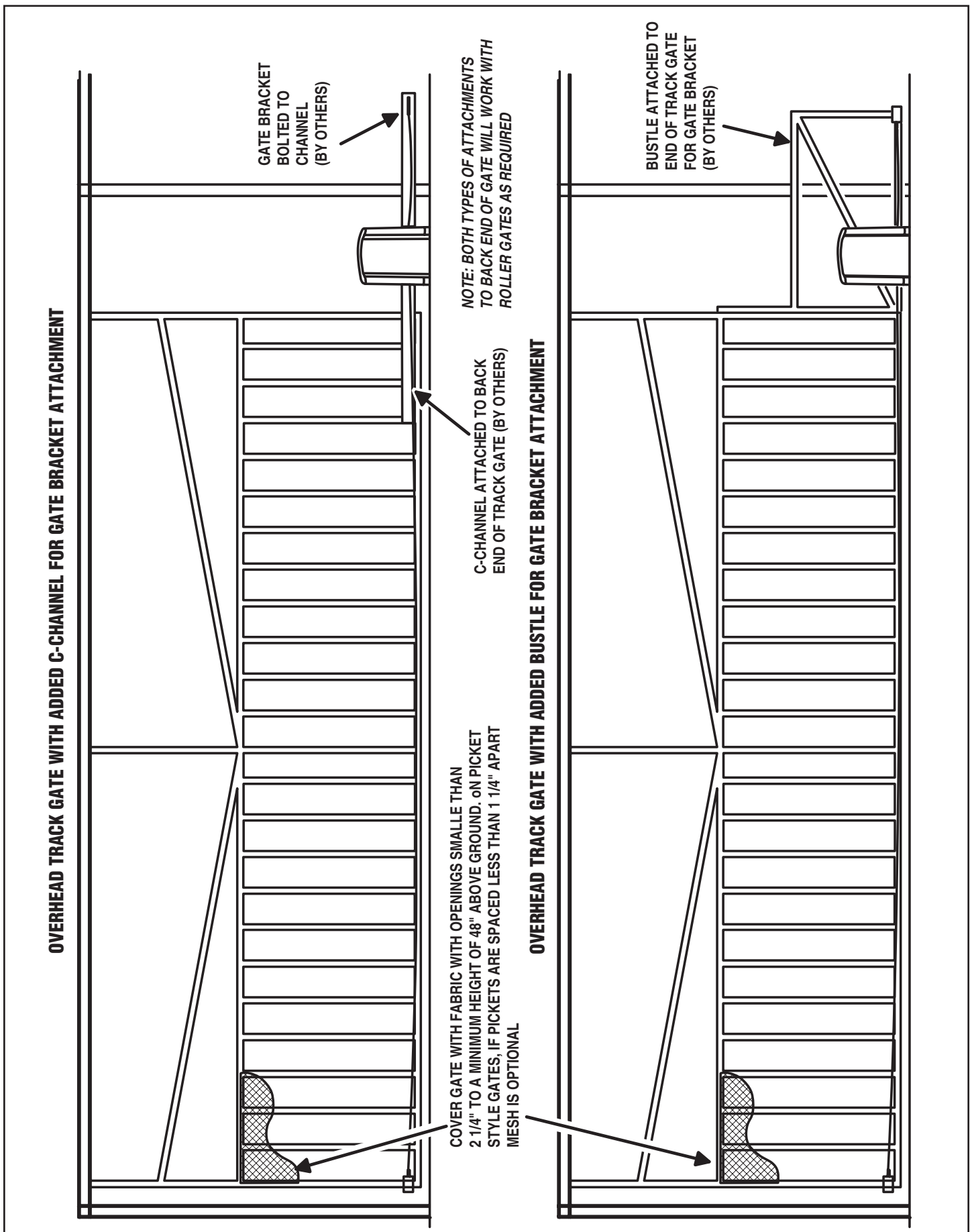

Dual Gate Installations

Two operators can be used in dual gate installations. The operators communicate with each other through the 3-wire **COMM LINK** terminals.

When one operator activates, the **COMM LINK** connection signals the other operator to activate. Each operator functions independently, controlling its gate and monitoring its inputs and accessories.

A three-wire shielded conductor cable is required to connect two operators together for dual operation. Use Belden 8760 Twisted Pair Shielded Cable (or equivalent) only – P/N 2500-1982, per foot).

✓ **NOTE:** *The shield wire should be connected COMM LINK terminal "C" in both operators.*

Three of the programming functions available are only used for dual gate installations:

- **Dual Gate Enable**
Dual Gate Enable must be set for all dual gate installations.
- **Stagger Mode**
The Stagger Mode function determines if the operator has a delayed open or a delayed close. In dual swing gate installations, typically one operator is programmed for delayed open, and the other operator is programmed for delayed close.
- **Stagger Delay Time**
The Stagger Time sets the length of the delay for the Stagger Mode.

See Pages 11, 13, & 14 for details on these three dual gate programming functions.

Set the following parameters in each gate operator individually in a single gate mode before connecting the network cable and operating in dual gate mode.

1. Open and Close Limit settings
2. Open and Closed direction inherent entrapment protection (OC & CC)

After these parameters have been set, and each operator has been tested independently and is functioning correctly in single gate mode, then set BOTH operators to dual gate (dg) in the Paired Mode setup step under Basic Programming steps.

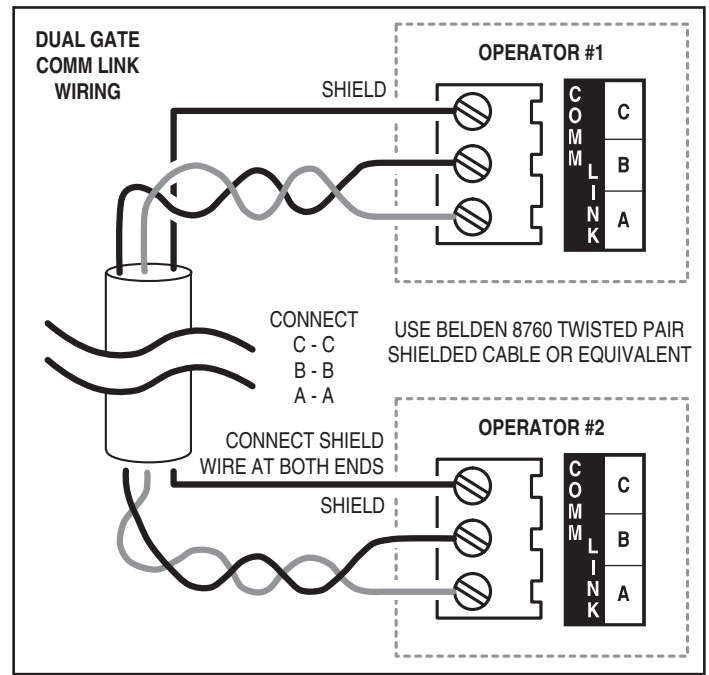

Figure 12. COMM LINK Wiring

Gate Operation

Open Button

Opens the gate. If the Controller is programmed to stop opening the gate at mid-travel, a constant press of the **OPEN** button will override the Mid-travel Stop and completely open the gate. If the Auto Close Timer is set, it will be suspended until the **OPEN** button is released.

Close Button

Closes the gate if the gate is open. Also closes the gate if the gate is in the process of opening.

Stop Button

Stops the gate from opening or closing at any time.

Single Input

Opens the gate if it's closed and closes the gate if it's open (open-close programming option). Activating the input while the gate is moving will reverse the gate.

Can be programmed to stop the gate while the gate is moving (open-stop-close programming option).

Fire Department Input

Fully opens the gate when the input is activated. Overrides the Mid-travel Stop and Auto Close Timer (if either is programmed for the gate). The gate will lockout in the open position without sounding the alarm. Press the **STOP** button to release the lockout.

Open Input

Functions the same as the **OPEN** button.

Open Obstruction

While the gate is opening, any open obstruction signal will cause the gate to stop, reverse a short distance, and then stop again. The Auto Close Timer will be disabled, and a renewed input will be required to start the gate again. Should the gate be restarted and the obstacle signal occur again prior to reaching a limit, the gate will stop again, lockout, and sound the emergency alarm.

Close Obstruction

While the gate is closing, any close obstruction signal will cause the gate to stop, reverse, and travel to the full open position. Should a open obstruction input or an open direction inherent entrapment condition occur prior to the gate reaching the open limit, the operator will lockout and sound the continuous tone alarm. Another close request will be required to start the operator again. If after restart, the overload or a close obstacle happens again before the close limit is reached, the operator will lockout and sound the alarm. If the auto close timer is set, when the close obstruction input is cleared, the gate will close when the auto close timer expires.

Reverse Input

If the reverse input is triggered while the gate is closing, the gate will reverse to the full open position. If the Auto Close Timer is set, when the reverse input is cleared, the gate will close when the Auto Close Timer expires.

Open Loop

Functions the same as the **OPEN** button.

Reverse Loop

Functions the same as the reverse input.

Shadow/reset Loop

Only used with Swing Gates. Holds the gate fully open or fully closed while triggered. If open, the gate closes immediately when cleared if Anti-tailgate is enabled.

Operation Indications

During normal operation, the Controller's displays will indicate current operating conditions and status.

Power-up Display

When the Controller powers up, dashes will show on the display, then the firmware version number, then the gate type (SL for slide and swing gates).

Exiting programming restarts the Controller. The power-up display will show upon the restart.

Idle Condition

While the Controller is idling, waiting for a command, the display will show circulating dashes.

For DC models only - Clockwise : Batteries discharging, Counterclockwise : Batteries charging.

Last Gate Position/Condition

When the gate moves or stops, the display will show the status for up to one minute.

- Stop is displayed as **St**
- Full Close is displayed as **FC**
- Full Open is displayed as **FO**
- Entrapment is displayed as **En**

Pre-start Delay

During the pre-start delay, the display will countdown the number of seconds remaining before the operator starts.

Reverse Delay

If the gate travel direction is reversed from a user activation or reversing device, and a reverse delay is set, the display will count down the delay time in seconds before the operator restarts.

Run Timer

While the gate is opening or closing, the number of seconds running time is displayed.

Error Indications

During abnormal operation, the Controller's displays and beeper will indicate the error condition that has occurred.

Entrapment

If an entrapment condition occurs detected by two repeated open or close obstruction triggers, the Controller will lock the operator out. The beeper will sound constantly and the gate will not operate. To reset the Controller press the **STOP** button or press the **RESET**

 WARNING 
The Stop and/or Reset button must be located in the line-of-sight of the gate. Activation of the reset control shall not cause the operator to start.

button on the operator's cover.

COMM LINK Connection Failure

In dual gate installations, if there is a connection failure between the two operators, the **COMM LINK** indicator will blink once a second. During this condition the gate will not operate, except if triggered by the **FIRE DEPT** input, which functions normally.

MGT Obstacle Transmitter Trouble

If any MGT transmitters are used with the operator, their supervision feature will alert the Controller if there is any trouble with the transmitter. MGT transmitters send hourly status reports and will send low battery reports when the transmitter has a low battery. The MGT transmitters also have a tamper detection switch that will trigger when their case is opened.

When the Controller detects a low transmitter battery, a tamper signal, or missing transmitter status reports, the gate will still operate normally, but the beeper will change as follows:

- The Pre-start Alarm will beep twice as fast.
- The Run Alarm will beep twice as fast and continue for five minutes after the gate stops.
- The sounder will "chirp" every five seconds when the gate is idle.

Correct the trouble (close case, replace battery, or replace transmitter) to clear the obstacle transmitter trouble indications.

Maximum Run Time Exceeded

If the Maximum Run Time is exceeded, the Controller stops the operator the same as if a double obstacle has occurred in an entrapment condition. The entrapment alarm sounds constantly, and is cleared by pressing the **STOP** button or the **RESET** button on the cover. After the **STOP** or **RESET** button is pressed, because the Maximum Run Time has been exceeded, the sounder will beep twice every five seconds. The next operation of the gate will clear the indication.

CONTROLLER ERROR CAUSES AND INDICATIONS		
ERROR CAUSE	ERROR INDICATION	HOW TO CLEAR
TWO SAFETY REVERSALS (ON SINGLE GATE OR ON EITHER DUAL GATE)	En 00, CONTINUOUS ALARM BEEPER, GATE DISABLED	PRESS STOP BUTTON
MAXIMUM RUN TIMER EXCEEDED ON OPENING	En 01, AND MAX RUN LED, CONTINUOUS ALARM BEEPER, GATE DISABLED	PRESS STOP BUTTON, CLEARS CONTINUOUS ALARM, THEN DOUBLE BEEP EVERY 5 SECONDS UNTIL NEXT OPERATION
MAXIMUM RUN TIMER EXCEEDED ON CLOSING	En 02, AND MAX RUN LED, CONTINUOUS ALARM BEEPER, GATE DISABLED	PRESS STOP BUTTON, CLEARS CONTINUOUS ALARM, THEN DOUBLE BEEP EVERY 5 SECONDS UNTIL NEXT OPERATION
COMM LINK FAILURE	En 03, AND COMM LINK LED, CONTINUOUS ALARM BEEPER FOR 1 MINUTE, GATE DISABLED (EXCEPT FOR FIRE DEPT INPUT)	PRESS STOP BUTTON, CLEARS CONTINUOUS ALARM
GATE FULL OPEN RESULTING FROM FIRE DEPT INPUT	En 04, GATE DISABLED	PRESS STOP BUTTON
FAIL SAFE OR FAIL SECURE BECAUSE OF BATTERY VOLTAGE DROP BELOW 21.6 VDC DUE TO AC POWER LOSS	En 05, GATE DISABLED	BATTERY VOLTAGE MUST RISE ABOVE 24 VDC
OTHER CONTROLLER IN ENTRAPMENT (DUAL GATE)	En 06, GATE DISABLED	CLEAR ENTRAPMENT ON OTHER CONTROLLER (PRESS STOP)
LOW AC VOLTAGE AT CONTROLLER	En 07, GATE DISABLED	RESTORE AC POWER TO NORMAL LEVEL
INPUT TRIGGERED DURING ENTRAPMENT LOCKOUT	En 08, GATE DISABLED	PRESS STOP BUTTON
COMPATIBILITY PROBLEM	En 09, GATE DISABLED	UPDATE FIRMWARE AND RESET BOTH PAIRED CONTROLLERS
EEPROM PROBLEM	En 10, GATE DISABLED	TRY RESET, CALL TECH. SUPPORT
DC MOTOR MISMATCH	En 11, GATE DISABLED	REPROGRAM MOTOR TYPE OR CHANGE DC MOTOR BOARD, NEXT GATE MOVEMENT WILL RETRY DC MOTOR CHECK
MOTOR FAILURE	En 12, GATE DISABLED	REPLACE MOTOR
AC POWER LOSS IN OPEN OR CLOSE IMMEDIATE POWER FAIL MODE	En 13	REAPPLY AC POWER
MAXIMUM RUN TIMER EXCEEDED AFTER AC POWER LOSS	En 14	BATTERY VOLTAGE MUST RISE ABOVE 24 VOLTS
MGT SUPERVISORY CONDITION (TAMPER, LOW BATTERY, MISSING HOURLY STATUS)	FAST BEEPS DURING PRESTART, FAST BEEP RUN ALARM, CHIRP EVERY 5 SECONDS AT IDLE	CLEARS WHEN MGT CONDITION CLEARS

Troubleshooting

Contacting Technical Support

For technical questions regarding Linear gate operators, contact the Technical Services Department at:

1-800-421-1587 from 6:30 AM to 4:30 PM Pacific time

Operator fails to start

- A. If the operator has been running a large number of cycles, the motor may have become too hot and tripped its thermal overload breaker. Allow the motor to cool down and the thermal overload breaker will reset automatically.
- B. Make sure you have power at the master distribution panel and that the power has not been turned off.
- C. On an SLD, if the "Reset to Factory Defaults" programming step has been used, ensure the motor type (MO) has been set to d2 and the open (OC) and closed currents (CC) have been set.

Motor operates, but gate does not move

- A. Check for broken chain or worn belts.
- B. Check all setscrews on pulleys and sprockets and tighten them if necessary, and check for keys which may have fallen loose from keyways.

Motor sounds like it is working harder than normal

- A. Make sure the gate is moving freely and without binding throughout its entire travel.
- B. Check the drive chain for obstructions (if the operator has one).
- C. If the operator has an internal brake mechanism, make sure it is releasing.

Limit switch getting out of time

- A. Check for proper tension on all limit chains to be sure there is no jumping taking place. Mark one tooth and its corresponding link and run the gate. If the marks have moved, the chain is skipping.
- B. Check the setscrews in limit sprockets for tightness. In rotary limit boxes, check the rotary limit nut for sloppiness or stripped threads. Replace if necessary.

Gate stopping part way open or closed (but no visible obstruction)

- A. The Controller may have received a false obstruction input triggered by current sensing set too low. Make sure the gate moves freely through its entire travel before adjusting the current sensing.
- B. The Maximum Run Timer may have counted down and expired. This can be caused by having the timer set too low, if a chain or belt is broken, or if a sprocket or pulley is slipping. When the timer expires, the gate stops and the beeper will sound.
- C. An obstruction signal from an accessory wired to the obstruction input may have triggered falsely. Check the control board for lit indicators for any of the following inputs: safety, shadow/reset, open obstruction, close obstruction, stop, etc. If any are lit when the operator should be running, remove all devices hooked to that function and hook them up one at a time and try to run the operator until the problem device is found. Refer to Page 8 for details on the control board indicators.

Gate staying open with automatic system

- A. If there are vehicle detectors used with the operator, one of the loops or loop detectors may be sending a false signal or needs to be reset. Observe the indicators on the loop detector. Unplug the detector and try running the operator.
- B. An opening or reversing device may be stuck or malfunctioning. Try disconnecting these devices and hook them back up one at a time and try running the operator until the malfunctioning device is found.
- C. Make sure the close limit switch isn't activated. If it is, the operator will think the gate is already closed.

How to Order Replacement Parts

Use the part numbers listed on the following pages.
Contact your local Linear dealer or distributor to order parts.

1. Supply the model number and serial number of your operator.
2. Specify the quantity of pieces needed and order by part number and name of part.
3. State whether to ship by freight, truck, parcel post, UPS or air express.
4. State whether transportation charges are to be prepaid or collect.
5. Specify name and address of person or company to whom parts are to be shipped.
6. Specify name and address of person or company to whom invoice is to be sent test

Model SLR Exploded View

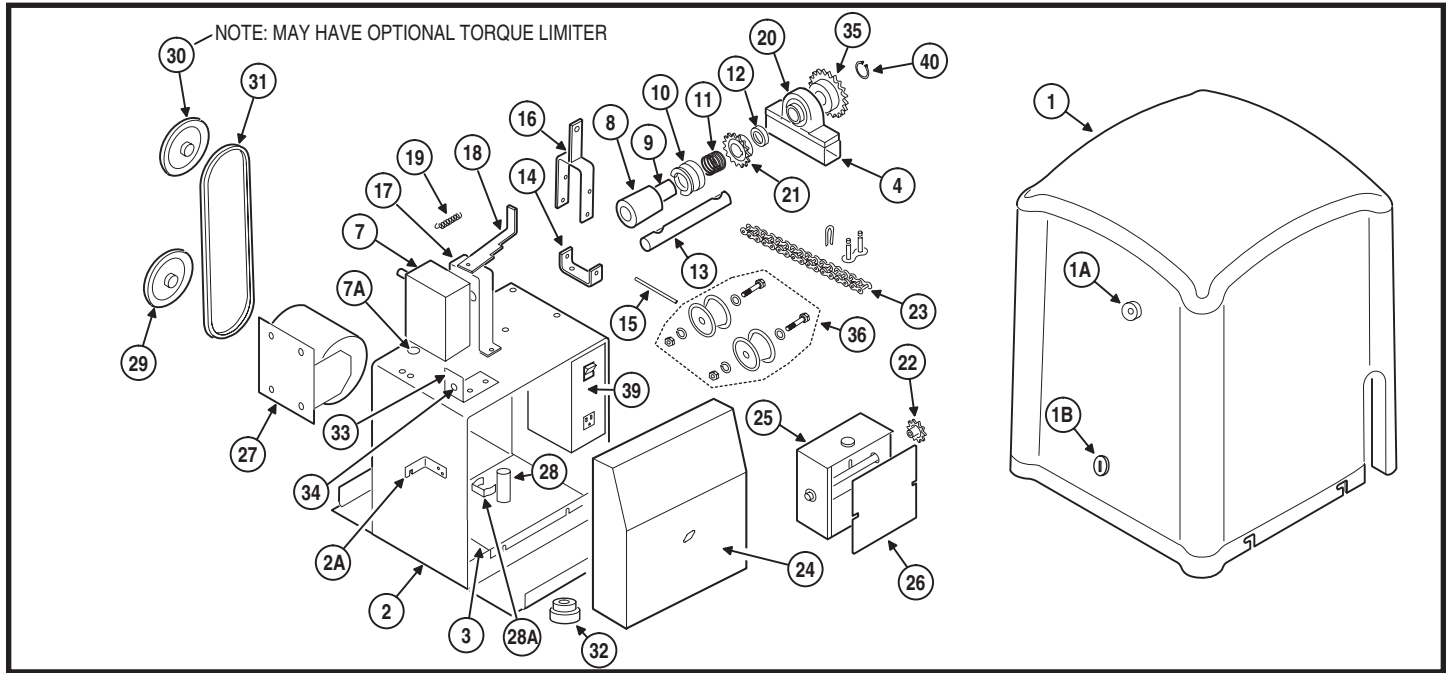

MODEL SLR MECHANICAL PARTS LIST		
REF. #	PART #	DESCRIPTION
1	2300-907	Operator Cover
1A	2510-354	Plunger Reset Assembly
	2500-2240	Plunger Reset Button
	2500-2241	Plunger Extension Only
1B	2200-790	Lock for Cover, with Keys
	2200-824	Extra Keys
2	2110-796	Main Frame Assembly
2A	2100-2006	Lock Tab Bracket
3	2100-2055	Bottom Shelf
4	2100-1985	Pillow Block Tube Spacer
7	2200-942	Gear Reducer, 20:1
7A	2100-1980	Gear Reducer Tube Spacer
8	2110-783	Reducer Coupler, with Oilite Bushing
10	2100-2026	Disconnect Collar
11	2200-115	Disconnect Collar Spring
12	2200-014	Shaft Collar, 1" diameter, 3/8" LTB
13	2100-1983	Drive Shaft, 1" diameter
13A	2100-529	1" Woodruff Key
14	2100-1986	Disconnect Handle Fulcrum Bracket
15	2100-549	Pin for Disconnect Handle
	2400-169	Push-on Nut, 1/4" (not shown)
	2120-477	Disconnect Handle
17	2100-2060	Disconnect Fulcrum Bracket
18	2100-2059	Disconnect Lever
19	2200-939	Locking Handle Spring
20	2200-274	Pillow Block Bearing, 1" diameter
21	2200-042	Sprocket, 48-B-15, 1" bore
22	2200-041	Sprocket, 48-B-15, 1/2" bore
23	2200-966	#48 Roller Chain, 15 Links
	2200-010	#48 Master Link
24	620-101293	APeX Module
	2100-2104	APeX Mounting Plate
	2300-1025	Controller Plastic Cover Only
	2510-423	Knob Kit
	2520-396-SLC	Limit Box Assembly with Cover
25	2100-057	Limit Shaft
	2200-029	Oilite Bushing
	2200-030	Limit Nut
	2200-193	1/2" E-ring
	2300-946	Heyco Bushing with Wire Guards
	2500-440	Limit Switch
	2100-261	Detent Plate
	2200-028	Detent Spring

REF. #	PART #	DESCRIPTION
26	2300-945	Limit Box Cover
	2510-274	Motor Assembly, 115 VAC, with Harness
27	2510-275	Motor Assembly, 230 VAC, with Harness
	2500-261	Capacitor for 115 VAC
28	2500-552	Capacitor for 230 VAC
	2200-872	Capacitor Clamp
29	2200-647	4" Pulley, 1/2" bore
30	2200-118	4" Pulley, 5/8" bore
31	2200-932	V-belt, 4L 31" Cogged
32	2500-2435	Alarm
33	2100-2114	Stop/Reset Button Bracket
34	2500-1495	Stop/Reset Button
35	2200-650	Sprocket, 41-B-24, 1" bore
	2110-823	Idler Assembly
	2300-697	Idler Wheel, UHMW
	2400-527	1/2" Shoulder Bolt
36	2400-528	1/2" Lock Washer
	2400-529	1/2" Nut
	2100-2109	APeX Controller Mounting Bracket (not shown)
37	2510-422	115 VAC Power Box Assembly
	2510-430	230 VAC Power Box Assembly
	2500-2411	Power Switch
	2500-2413	Power Outlet (only available on 115 VAC Models)
	2500-212	115 VAC - 24 VAC Power Transformer
	2500-791	230 VAC - 24 VAC Power Transformer
	2100-2113	Back Plate
2100-2112	Cover Plate	
38	2510-424	115 VAC Wiring Harness Assembly (not shown)
	2510-428	230 VAC Wiring Harness Assembly (not shown)
39	2510-424	115 VAC Wiring Harness Assembly (not shown)
	2510-428	230 VAC Wiring Harness Assembly (not shown)
40	2400-501	1" Rotor Clip
	PARTS FROM ACCESSORY BOX (Not shown in exploded view)	
	2100-2007	Gate Attachment Bracket
	2400-170	U-bolt, 3"
	2100-054	#41 Chain Tension Bolt
	2200-367	Chain Spring
	2200-027	#41 Master Link
	2200-150	#41 Chain, per Foot
	2400-152	Square Head Bolt, 3/8"
OPTIONAL PARTS		
	2100-2010	Base Plate for Operator
	2100-2008	Critter Plate
	2650-107	Remote Disconnect Kit
	2120-483	Post Mounting Kit
	2220-045	2" Torque Limiter Assembly Complete
	2300-693	Friction Disc (Pair)
	2200-676	4" Pulley for Torque Limiter
	2200-877	Bushing for Pulley

Model SLC Exploded View

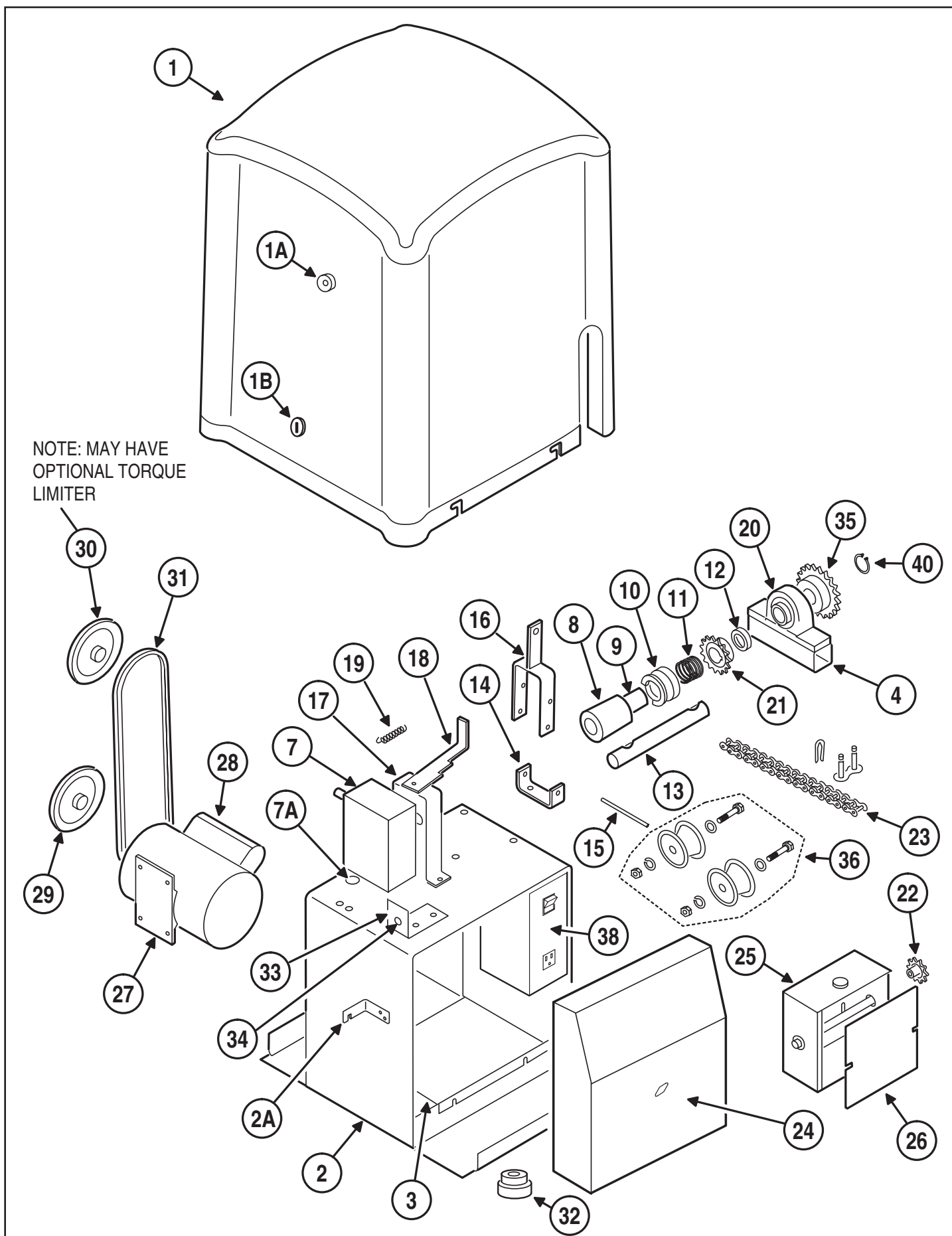

MODEL SLC MECHANICAL PARTS LIST		
REF. #	PART #	DESCRIPTION
1	2300-907	Operator Cover
1A	2510-354	Plunger Reset Assembly
	2500-2240	Plunger Reset Button
1B	2500-2241	Plunger Extension Only
	2200-790	Lock for Cover, with Keys
	2200-824	Extra Keys
2	2110-796	Main Frame Assembly
2A	2100-2006	Lock Tab Bracket
3	2100-2055	Bottom Shelf
4	2100-1985	Pillow Block Tube Spacer
7	2200-954	Gear Reducer, 20:1
7A	2100-2062	Reducer Spacer
8	2110-777	Reducer Coupler, with Oilite Bushing
10	2100-2026	Disconnect Collar
11	2200-115	Disconnect Collar Spring
12	2200-014	Shaft Collar, 1" diameter, 3/8" LTB
13	2100-1983	Drive Shaft, 1" diameter
13A	2100-529	1" Woodruff Key
14	2100-1986	Disconnect Handle Fulcrum Bracket
15	2100-549	Pin for Disconnect Handle
	2400-169	Push-on Nut, 1/4" (not shown)
16	2120-477	Disconnect Handle
17	2100-2060	Disconnect Fulcrum Bracket
18	2100-2059	Disconnect Lever
19	2200-939	Locking Handle Spring
20	2200-274	Pillow Block Bearing, 1" diameter
21	2200-042	Sprocket, 48-B-15, 1" bore
22	2200-041	Sprocket, 48-B-15, 1/2" bore <i>(For drives less than 34 feet wide)</i>
	2200-276	Sprocket, 48-B-20, 1/2" bore <i>(For drives 34 to 47 feet wide)</i>
23	2200-554	#48 Roller Chain, 14 Links (Use with 2200-008 Sprocket)
	2200-966	#48 Roller Chain, 15 Links (Use with 2200-041 Sprocket)
	2200-855	#48 Roller Chain, 16 Links (Use with 2200-276 Sprocket)
	2200-010	#48 Master Link
24	620-101293	APeX Module
	2100-2104	APeX Mounting Plate
	2300-1025	Plastic Cover
	2510-423	Knob Kit
25	2520-396-SLC	Limit Box Assembly with Cover
	2100-057	Limit Shaft
	2200-029	Oilite Bushing
	2200-030	Limit Nut
	2200-193	1/2" E-ring
	2300-946	Heyco Bushing with Wire Guards
	2500-440	Limit Switch
	2100-261	Detent Plate
2200-028	Detent Spring	
26	2300-945	Limit Box Cover

REF. #	PART #	DESCRIPTION
MOTORS		
27	2500-2307	1/2 HP, 115 VAC, 1 Phase
	2500-2308	1/2 HP, 208/230 VAC, 1 Phase
	2500-2309	3/4 HP, 115 VAC, 1 Phase
	2500-2310	3/4 HP, 208/230 VAC, 1 Phase
	2500-2311	1 HP, 115 VAC, 1 Phase
	2500-2312	1 HP, 208/230 VAC, 1 Phase
CAPACITORS		
28	2500-2336	Capacitor for 2500-2307 Motor
	2500-2337	Capacitor for 2500-2308 Motor
	2500-1926	Capacitor #1 for 2500-2309 Motor
	2500-1930	Capacitor #2 for 2500-2309 Motor
	2500-1931	Capacitor for 2500-2310 Motor
	2500-2338	Capacitor for 2500-2311 Motor
	2500-1932	Capacitor for 2500-2312 Motor
29	2200-118	4" Pulley, 5/8" bore
30	2200-955	4" Pulley, 3/4" bore
31	2200-962	V-belt, 4L 35" Cogged
32	2500-2435	Alarm
33	2100-2114	Stop/Reset Button Bracket
34	2500-1495	Stop/Reset Button
35	2200-650	Sprocket, 41-B-24, 1" bore
36	2110-823	Idler Assembly
	2300-697	Idler Wheel, UHMW
	2400-527	1/2" Shoulder Bolt
	2400-528	1/2" Lock Washer
	2400-529	1/2" Nut
37	2100-2109	APeX Controller Mounting Bracket (not shown)
38	2510-422	115 VAC Power Box Assembly
	2510-430	230 VAC Power Box Assembly
	2500-2411	Power Switch
	2500-2413	Power Outlet (only available on 115 VAC Models)
	2500-212	115 VAC - 24 VAC Power Transformer
	2500-791	230 VAC - 24 VAC Power Transformer
	2100-2113	Back Plate
2100-2112	Cover Plate	
39	2510-424	115 VAC Wiring Harness Assembly (not shown)
	2510-428	230 VAC Wiring Harness Assembly (not shown)
40	2400-501	1" Rotor Clip
PARTS FROM ACCESSORY BOX (Not shown in exploded view)		
	2100-2007	Gate Attachment Bracket
	2400-170	U-bolt, 3"
	2100-054	#41 Chain Tension Bolt
	2200-367	Chain Spring
	2200-027	#41 Master Link
	2200-150	#41 Chain, per Foot
	2400-152	Square Head Bolt, 3/8"
OPTIONAL PARTS		
	2100-2010	Base Plate for Operator
	2100-2008	Critter Plate
	2650-107	Remote Disconnect Kit
	2120-483	Post Mounting Kit
	2220-045	2" Torque Limiter Assembly Complete
	2300-693	Friction Disc (Pair)
	2200-676	4" Pulley for Torque Limiter
	2200-877	Bushing for Pulley

Model SLD Exploded View

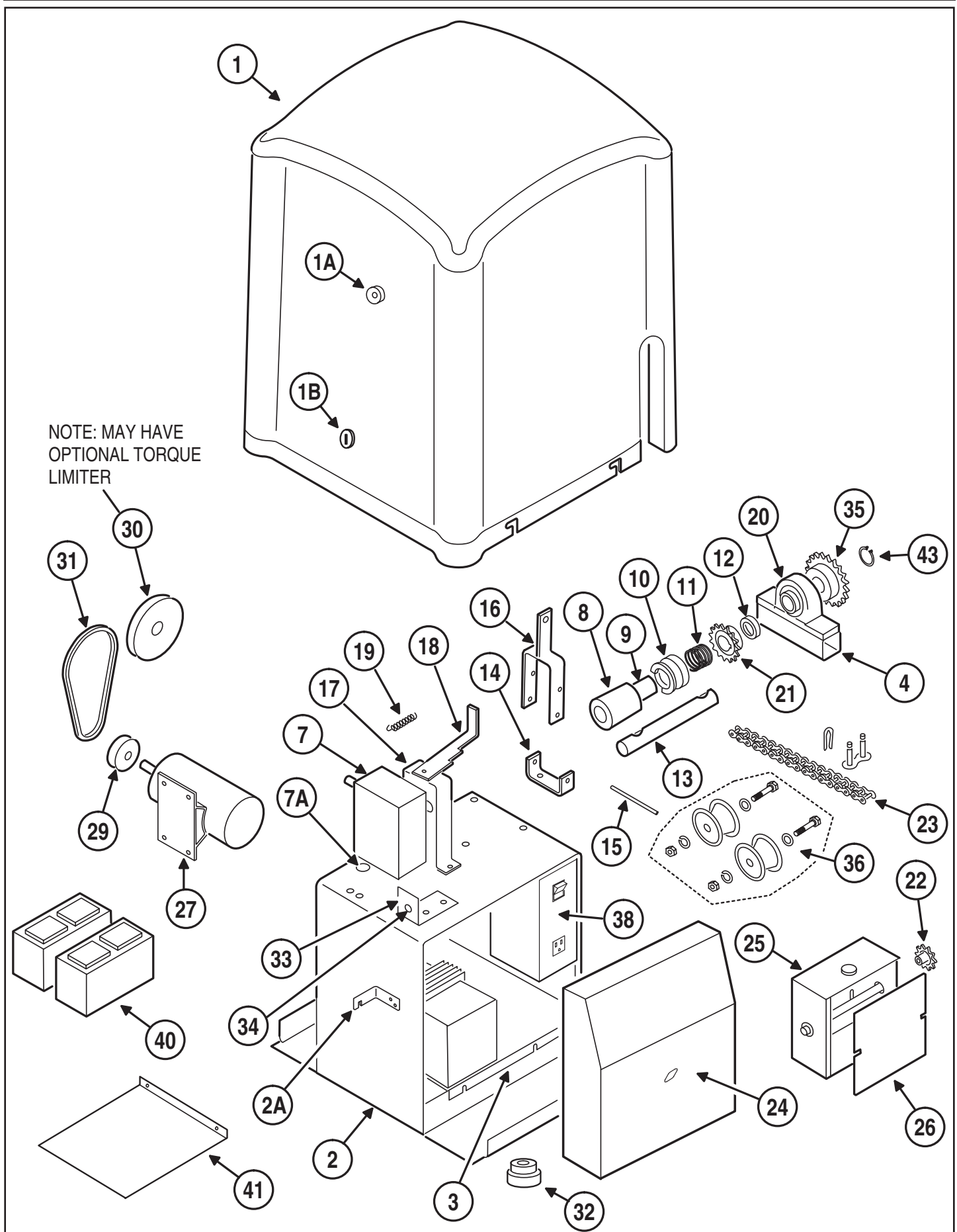

MODEL SLD MECHANICAL PARTS LIST		
REF. #	PART #	DESCRIPTION
1	2300-907	Operator Cover
1A	2510-354	Plunger Reset Assembly
	2500-2240	Plunger Reset Button
	2500-2241	Plunger Extension Only
1B	2200-790	Lock for Cover, with Keys
	2200-824	Extra Keys
2	2110-796	Main Frame Assembly
2A	2100-2006	Lock Tab Bracket
3	2100-2055	Bottom Shelf
4	2100-1985	Pillow Block Tube Spacer
7	2200-954	Gear Reducer, 20:1
7A	2100-1980	Tube Spacers
8	2110-783	Reducer Coupler, with Oilite Bushing
10	2100-2026	Disconnect Collar
11	2200-115	Disconnect Collar Spring
12	2200-014	Shaft Collar, 1" diameter, 3/8" LTB
13	2100-1983	Drive Shaft, 1" diameter
13A	2100-529	1" Woodruff Key
14	2100-1986	Disconnect Handle Fulcrum Bracket
15	2100-549	Pin for Disconnect Handle
	2400-169	Push-on Nut, 1/4" (not shown)
16	2120-477	Disconnect Handle
17	2100-2060	Disconnect Fulcrum Bracket
18	2100-2059	Disconnect Lever
19	2200-939	Locking Handle Spring
20	2200-274	Pillow Block Bearing, 1" diameter
21	2200-042	Sprocket, 48-B-15, 1" bore
22	2200-041	Sprocket, 48-B-15, 1/2" bore
23	2200-966	#48 Roller Chain, 15 Links
	2200-010	#48 Master Link
24	2510-439	APeX Module & DC Motor Board Assembly
	620-101293	APeX Module
	2500-2399	APeX DC Motor Board
	2100-2104	APeX Mounting Plate
	2300-1025	Plastic Cover
	2510-423	Knob Kit
25	2520-396-SLC	Limit Box Assembly with Cover
	2100-057	Limit Shaft
	2200-029	Oilite Bushing
	2200-030	Limit Nut
	2200-193	1/2" E-ring
	2300-946	Heyco Bushing with Wire Guards
	2500-440	Limit Switch
	2100-261	Detent Plate
26	2200-028	Detent Spring
	2300-945	Limit Box Cover

REF. #	PART #	DESCRIPTION
27	2500-1902	Motor, 24 VDC
	2510-243	Brush Replacement Kit
29	2200-132	Motor Pulley, 2"
30	2200-993	3" Pulley, 3/4" bore
31	2200-975	V-belt, 4L 29" Cogged
32	2500-2435	Alarm
33	2100-2114	Stop/Reset Button Bracket
34	2500-1495	Stop/Reset Button
35	2200-269	Sprocket, 41-B-20, 1" bore
	2110-823	Idler Assembly
36	2300-697	Idler Wheel, UHMW
	2400-527	1/2" Shoulder Bolt
	2400-528	1/2" Lock Washer
	2400-529	1/2" Nut
37	2100-2109	APeX Controller Mounting Bracket (not shown)
38	2510-431	Power Box Assembly
	2500-2411	Power Switch
	2500-2413	Power Outlet
	2500-2473	Relay
	2500-1768	Bridge Rectifier
	2500-1819	Fuse Holder
39	2500-1748	Fuse, 10 Amp, Slow-blow
	2510-419	Transformer Assembly
40	2510-182	Battery Assembly
	2500-1118	Battery, 12 Volt (Two required)
	2300-450	Velcro Tape, per Foot
41	2100-2115	Accessory Shelf
42	2510-425	Wiring Harness Assembly (not shown)
43	2400-501	1" Rotor Clip
PARTS FROM ACCESSORY BOX (Not shown in exploded view)		
	2100-2007	Gate Attachment Bracket
	2400-170	U-bolt, 3"
	2100-054	#41 Chain Tension Bolt
	2200-367	Chain Spring
	2200-027	#41 Master Link
	2200-150	#41 Chain, per Foot
	2400-152	Square Head Bolt, 3/8"
OPTIONAL PARTS		
	2100-2010	Base Plate for Operator
	2100-2008	Critter Plate
	2650-107	Remote Disconnect Kit
	2120-483	Post Mounting Kit
	2220-045	2" Torque Limiter Assembly Complete
	2300-693	Friction Disc (Pair)
	2200-676	4" Pulley for Torque Limiter
	2200-877	Bushing for Pulley

Model SLD Maintenance

Battery Maintenance

The gel-cell batteries in this operator require no routine maintenance. For assured continued performance, they should be replaced every year. If power is to be removed for one week or more, disconnect the negative wire from the batteries as this will prevent deep discharging. Fully charge before use after storage or upon initial installation.

DC Motor Brush Replacement

Brushes should be inspected every 100,000 cycles or yearly, whichever comes first. The motor has two brushes, one on each side.

Original brushes are approximately 3/4" long and should be replaced when they are 1/2" long, or sooner. If brushes are allowed to wear beyond this point, permanent damage to the motor may result.

To inspect the brushes: (1) remove the retaining cap with straight-blade screwdriver; (2) carefully pull assembly straight out; (3) measure the remaining brush material.

To reinstall: (4) place the brush in holder, aligning the brush's rounded indentation correctly with motor shaft; (5) gently push in the spring and align metal contact with oval slot in the brush holder, then push it in with retaining cap. Hold the cap in place and thread the cap into brush holder. **Do not overtighten or cap will crack!**

Repeat for the other brush.

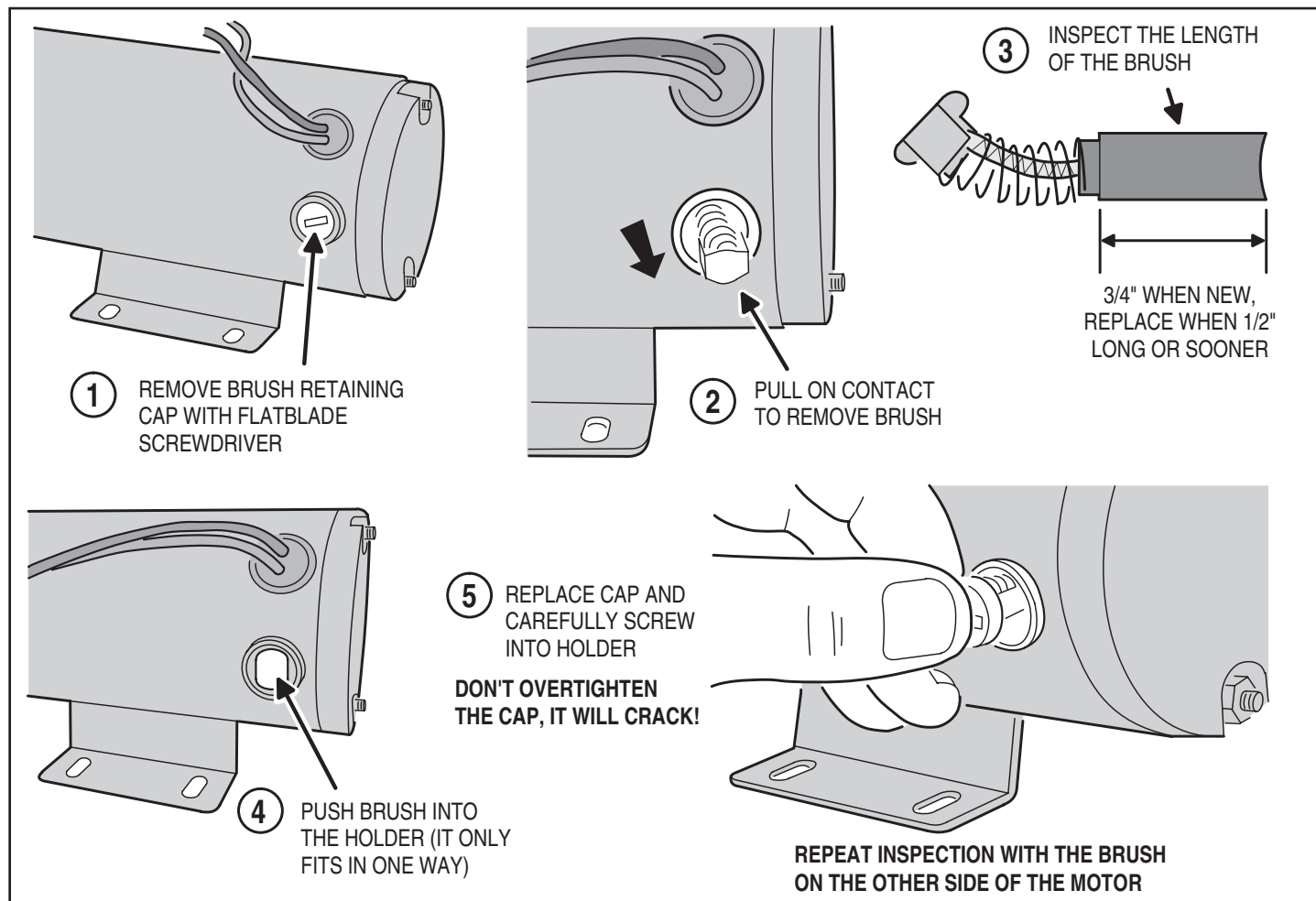

Figure 13. Replacing DC Motor Brushes

Preventative Maintenance



WARNING

**Always disconnect power from operator before servicing.
Keep clear of gate during operation.**

General

Linear gate operators are designed for many years of trouble-free operation and, under recommended operating conditions, will require only minimal maintenance. To ensure that a unit is ready for operation at all times, and to preclude serious damage or failure, inspect the unit systematically. Proper adjustments and lubrication should be made as recommended.

Lubrication

- ✓ **Bearings** — For models which have pillow block style bearings with grease fittings, lubricate at least twice a year with a lithium complex based, petroleum oil NLGI 2 rated grease. Oilite and precision sealed bearings do not require additional lubrication.
- ✓ **Motor** — Motors have sealed ball bearings and do not require further lubrication. If bearing noise develops after several years of operation, bearings should be replaced by a motor repair company, or the motor should be replaced if necessary.
- ✓ **Drive Chain and Sprocket** — The main drive chain and sprockets should be inspected for wear, cleaned, and wiped down with a lightly oiled rag every six months.

6-Month Preventative Maintenance

1. For operators with V-belts, inspect for wear and replace as necessary. Check for proper tension and adjust if required. Check all pulley setscrews for tightness and tighten if necessary.
2. For operators with internal chain drives, inspect chain and sprockets for wear and replace if necessary. Check for proper tension and alignment, and adjust if required. Check all hub sprocket setscrews and tighten if required.
3. Check limit switches and limit actuators (cams, limit nuts, etc.) for wear and replace as required. In rotary limit switch assemblies, wipe the limit shaft clean and apply a light coating of dry lubricant.
4. For operators with magnetic brakes, check for proper adjustment. Brake disc must run free when the brake is engaged. For brake assemblies other than C-face style, the brake should be adjusted so that the solenoid plunger throw is between 3/8" to 1/2". Too much throw will damage the solenoid. **If the solenoid emits a loud buzzing sound when the motor is run, the brake must be adjusted.**
5. In operators which have a disconnect handle, inspect disconnect handle for proper function and lubricate if necessary. Use a lithium based grease on all moving parts.
6. Inspect all nuts and bolts for proper tightness and tighten as necessary.
7. Check all reversing devices for proper function. Inspect all contact edges for wear and replace if required. Check photoeyes for proper alignment and function.
8. Check current sensing for proper adjustment when finished with inspection and maintenance.
9. Inspect the installation area. Are all the warning signs intact and visible? If they are missing or need replaced, contact Linear. Be sure there are no control stations mounted within reach of the gate. Review safety literature with the customer and advise them to remove any such stations found.

FCC Notice

This device complies with FCC Rules Part 15 and Industry Canada Rules & Regulations. Operation is subject to the following two conditions: (1) This device may not cause harmful interference and (2) this device must accept any interference received, including interference that may cause undesired operation.

For all gate operators, you must inspect the gate for proper operation. The gate should move easily without binding through its entire travel. If the gate does bind, adjust or fix as required. Failure to keep the gate in good working condition will have adverse effects on the operator.

Gate Operator Installation Checklist

INSTALLER CUSTOMER

- | | | |
|--------------------------|--------------------------|--|
| <input type="checkbox"/> | <input type="checkbox"/> | 1. The gate has been checked to make sure it is level and moves freely in both directions. |
| <input type="checkbox"/> | <input type="checkbox"/> | 2. Potential pinch areas have been guarded so as to be inaccessible OR have contact and/or non-contact obstruction sensing devices installed. |
| <input type="checkbox"/> | <input type="checkbox"/> | 3. The installer has installed one or more approved obstruction detection devices, in compliance with UL325 requirements for this installation. |
| <input type="checkbox"/> | <input type="checkbox"/> | 4. If pedestrian traffic is expected, a separate pedestrian gate has been installed, a minimum of seven feet from the gate. The customer has been informed that <u>all pedestrian traffic must use the pedestrian gate.</u> |
| <input type="checkbox"/> | <input type="checkbox"/> | 5. Warning signs have been installed on each side of the gate in highly visible locations. The customer has been informed that these signs must remain at all times. |
| <input type="checkbox"/> | <input type="checkbox"/> | 6. There are no controls installed on the gate operator, or within seven feet of the gate. |
| <input type="checkbox"/> | <input type="checkbox"/> | 7. The installer has properly adjusted the obstruction sensing feature and has tested the gate to make sure that the gate stops and reverses a short distance with minimal resistance applied (40 lbs. on a swing gate at the end of the gate, 75 lbs. on a slide gate) |
| <input type="checkbox"/> | <input type="checkbox"/> | 8. The installer has instructed the customer in the proper use of the gate operator and reviewed all of the operational functions, obstruction sensing devices, warning beeper and reset, etc. |
| <input type="checkbox"/> | <input type="checkbox"/> | 9. The installer has instructed the customer in the proper use of the operator's manual disconnect feature. The manual disconnect must never be used while the gate is in motion. The power switch must be turned off before using the manual disconnect and disengaging the operator. |
| <input type="checkbox"/> | <input type="checkbox"/> | 10. The installer has reviewed all safety instructions with the customer, and has left the safety instructions and owner's information sheets for their reference. |
| <input type="checkbox"/> | <input type="checkbox"/> | 11. The installer has answered any questions the customer has regarding the operation of the gate operator and gate operator safety precautions. |
| <input type="checkbox"/> | <input type="checkbox"/> | 12. The installer has explained to the customer that a regular maintenance schedule for both the gate and the gate operator is recommended. |

By signing this installation checklist, I/we hereby certify that each item listed and checked above has been covered by the installer and is clearly understood by the customer.

Customer's Signature

Date

Installer's Signature

Date

