

Installation Guide for

MAX 1200FS PRO MAX 1700FS PRO

MATRIX III

Fail Safe Slide Gate Operator

CONFORMS TO UL STD 325
UL CLASS - I, II, III, IV

SAFETY SENSORS REQUIRED

CERTIFIED TO CAN/CSA STD
C22.2 NO. 247



Residential/Commercial Brushless DC Slide Gate Operators

Made in USA



Intertek
4009963



UL 325 COMPLIANT INSTALLATION REQUIREMENTS

a) Install the gate operator only when:

a) N'installez l'ouvre-barrière que si :

1) The operator is appropriate for the construction of the gate and the usage Class of the gate,

1) l'ouvre-barrière est approprié pour la structure et la classe d'utilisation de la barrière;

2) All openings of a horizontal slide gate are guarded or screened from the bottom of the gate to a minimum of 1.83 m (6 ft) above the ground to prevent a 57.2 mm (2-1/4 inch) diameter sphere from passing through the openings anywhere in the gate, and in that portion of the adjacent fence that the gate covers in the open position,

2) toutes les ouvertures de la barrière coulissante sont protégées ou grillagées du bas de la porte jusqu'à un minimum de 1,83 m (6 pi) du sol si bien qu'une sphère de 57,2 mm (2 1/4 po) de diamètre ne peut passer par une ouverture au niveau de la barrière et de la portion de la clôture adjacente que la barrière couvre en position ouverte;

3) All exposed pinch points are eliminated or guarded, and

3) tous les points de pincement sont éliminés ou protégés;

4) Guarding is supplied for exposed rollers.

4) des protections sont fournies pour les galets exposés.

b) The operator is intended for installation only on gates used for vehicles. Pedestrians must be supplied with a separate access opening. The pedestrian access opening shall be designed to promote pedestrian usage. Locate the gate such that persons will not come in contact with the vehicular gate during the entire path of travel of the vehicular gate.

b) L'ouvre-barrière est destiné à n'être installé que sur des barrières utilisées pour les véhicules. Il faut fournir une autre voie d'accès aux piétons. La voie d'accès pour les piétons doit être conçue pour favoriser le passage des piétons. Placez la barrière de sorte que personne ne puisse entrer en contact avec la barrière pour les véhicules sur l'ensemble de sa trajectoire.

c) The gate must be installed in a location so that enough clearance is supplied between the gate and adjacent structures when opening and closing to reduce the risk of entrapment. Swinging gates shall not open into public access areas.

c) Pour réduire les risques de coincement lors de l'ouverture et de la fermeture, la barrière doit être installée dans un endroit où la barrière et les structures avoisinantes sont suffisamment éloignées l'une de l'autre. Les barrières battantes ne doivent pas ouvrir dans une zone d'accès public.

d) The gate must be properly installed and work freely in both directions prior to the installation of the gate operator. Do not over-tighten the operator clutch or pressure relief valve to compensate for a damaged gate.

d) La barrière doit être bien installée et fonctionner librement dans les deux directions avant d'entreprendre l'installation de l'ouvre-barrière. Ne serrez pas trop l'embrayage ou la soupape de surpression de l'ouvre-barrière pour compenser une barrière endommagée.

e) For gate operators utilizing Type D protection:

e) Pour les ouvre-barrières qui utilisent des protections de type D :

1) The gate operator controls must be placed so that the user has full view of the gate area when the gate is moving,

1) les commandes de l'ouvre-barrière doivent être placées de sorte que l'utilisateur voit l'ensemble de la zone de la barrière lorsque cette dernière est en mouvement;

2) The placard as required by 62.1.6 shall be placed adjacent to the controls,

2) l'étiquette requise selon la clause 62.1.6 doit être placée à côté des commandes;

3) An automatic closing device (such as a timer, loop sensor, or similar device) shall not be employed, and

3) un dispositif de fermeture automatique (comme une minuterie, une boucle de détection ou un dispositif similaire) ne doit pas être utilisé;

4) No other activation device shall be connected.

4) aucun autre appareil d'activation ne doit être connecté.

f) Controls intended for user activation must be located at least 1.83 m (6 ft) away from any moving part of the gate and where the user is prevented from reaching over, under, around or through the gate to operate the controls.

f) Les commandes destinées à l'activation par l'utilisateur doivent être situées à au moins 1,83 m (6 pi) des pièces mobiles de la barrière et à un endroit où l'utilisateur ne peut pas atteindre les commandes par le dessus, par le dessous, par les côtés et au travers de la barrière.

Exception: Emergency access controls only accessible by authorized personnel (e.g. fire, police, EMS) may be placed at any location in the line-of-sight of the gate.

Exception : Les commandes d'accès d'urgence accessibles au personnel autorisé seulement (p. ex. pompier, policier, SMU) peuvent être placées à tout endroit dans le champ de visibilité de la barrière.

UL 325 COMPLIANT INSTALLATION REQUIREMENTS CONTINUED

- g) The Stop and/or Reset button must be located in the line-of-sight of the gate. Activation of the reset control shall not cause the operator to start.
g) Le bouton d'arrêt, le bouton de réenclenchement ou ces deux boutons doivent être situés dans le champ de visibilité de la barrière. L'activation des commandes de réenclenchement ne doit pas mettre en marche l'ouvrebarrière.
- h) A minimum of two (2) WARNING SIGNS shall be installed, in the area of the gate. Each placard is to be visible by persons located on the side of the gate on which the placard is installed. Also see 62.1.1.
h) Au moins deux panneaux de mise en garde doivent être installés dans la zone de la barrière. Chaque étiquette doit être visible des personnes situées de chaque côté de la barrière sur laquelle l'étiquette est installée. Voir aussi la clause 62.1.1.
- i) For gate operators utilizing a non-contact sensor in accordance with 32.1.1:
i) Pour les ouvre-barrières qui fonctionnent avec des capteurs sans contact conformément à la clause 32.1.1 :
1) See instructions on the placement of non-contact sensors for each Type of application,
1) Voir les instructions sur le positionnement des capteurs sans contact pour chaque type d'utilisation.
2) Care shall be exercised to reduce the risk of nuisance tripping, such as when a vehicle, trips the sensor while the gate is still moving, and
2) Des précautions doivent être prises pour réduire les risques de déclenchement inutile, comme lorsqu'un véhicule déclenche le capteur alors que la barrière est encore en mouvement.
3) One or more non-contact sensors shall be located where the risk of entrapment or obstruction exists, such as the perimeter reachable by a moving gate or barrier.
3) Un capteur sans contact ou plus doit être situé où il existe un risque de coincement ou d'obstruction, comme dans l'espace que peut occuper la barrière lorsqu'elle est en mouvement.
- j) For a gate operator utilizing a contact sensor in accordance with 32.1.1:
j) Pour les ouvre-barrières qui fonctionnent avec des capteurs de contact conformément à la clause 32.1.1 :
1) One or more contact sensors shall be located where the risk of entrapment or obstruction exists, such as at the leading edge, trailing edge, and postmounted both inside and outside of a vehicular horizontal slide gate.
1) Au moins un capteur de contact doit être situé où il existe un risque de coincement ou d'obstruction, comme sur le bord d'ouverture, sur le bord de fermeture et sur les poteaux montés sur l'intérieur ou l'extérieur d'une barrière coulissante pour véhicules.
2) One or more contact sensors shall be located at the bottom edge of a vehicular vertical lift gate.
2) Au moins un capteur de contact doit être situé sur le bord inférieur d'une barrière levante pour véhicules.
3) One or more contact sensors shall be located at the pinch point of a vehicular vertical pivot gate.
3) Au moins un capteur de contact doit être situé au point de pincement d'une barrière à pivot vertical pour véhicules.
4) A hardwired contact sensor shall be located and its wiring arranged so that the communication between the sensor and the gate operator is not subjected to mechanical damage.
4) Un capteur de contact doit être installé et câblé de sorte à éviter que la communication entre le capteur et l'ouvrebarrière soit gênée par des dommages mécaniques.
- 5) A wireless device such as one that transmits radio frequency (RF) signals to the gate operator for entrapment protection functions shall be located where the transmission of the signals are not obstructed or impeded by building structures, natural landscaping or similar obstruction. A wireless device shall function under the intended end-use conditions.
5) Un dispositif sans fil, comme un appareil qui transmet des signaux de radiofréquence (RF) à l'ouvre-barrière pour prévenir le coincement, doit être situé à un endroit où la transmission des signaux ne sera pas obstruée ou gênée par des structures, des arbres ou d'autres obstacles similaires. Un dispositif sans fil doit fonctionner selon les conditions d'utilisation finale prévues.
- 6) One or more contact sensors shall be located on the inside and outside leading edge of a swing gate. Additionally, if the bottom edge of a swing gate is greater than 152 mm (6 inches) but less than 406 mm (16 inches) above the ground at any point in its arc of travel, one or more contact sensors shall be located on the bottom edge.
6) Au moins un capteur de contact doit être situé sur les bords d'ouverture intérieur et extérieur d'une barrière battante. De plus, si le dessous d'une barrière battante est situé à plus de 152 mm (6 po) mais à moins de 406 mm (16 po) du sol à l'un des points de sa trajectoire, au moins un capteur de contact doit être situé sur le bord inférieur.
- 7) One or more contact sensors shall be located at the bottom edge of a vertical barrier (arm).
7) Au moins un capteur de contact doit être situé sur le bord inférieur d'une barrière verticale (bras).

IMPORTANT SAFETY INFORMATION

IMPORTANT SAFETY INSTRUCTIONS WARNING – To reduce the risk of injury or death:
INSTRUCTIONS DE SÉCURITÉ IMPORTANTES AVERTISSEMENT – Pour réduire les risques de blessures et de mort :

1. READ AND FOLLOW ALL INSTRUCTIONS.
1. LISEZ ET SUIVEZ TOUTES LES INSTRUCTIONS.
2. Never let children operate or play with gate controls. Keep the remote control away from children.
2. Ne laissez jamais les enfants manoeuvrer les commandes de la barrière ou jouer avec celles-ci. Laissez la télécommande hors de la portée des enfants.
3. Always keep people and objects away from the gate. NO ONE SHOULD CROSS THE PATH OF THE MOVING GATE.
3. Tenez toujours à l'écart de la barrière toute personne ou tout objet avoisinant. IL NE FAUT JAMAIS PASSER DANS LA TRAJECTOIRE D'UNE BARRIÈRE EN MOUVEMENT.
4. Test the gate operator monthly. The gate MUST reverse on contact with a rigid object or stop when an object activates the non-contact sensors. After adjusting the force or the limit of travel, retest the gate operator. Failure to adjust and retest the gate operator properly can increase the risk of injury or death.
4. Vérifiez le fonctionnement de l'ouvre-barrière une fois par mois. Le sens de la course DOIT s'inverser lorsque la barrière entre en contact avec un objet dur ou la barrière DOIT s'arrêter lorsqu'un objet active les capteurs sans contact. Vérifiez à nouveau l'ouvre-barrière après tout réglage de la force de déclenchement ou du seuil de fin de course. Un réglage incorrect de l'ouvre-barrière ou l'omission de vérifier à nouveau le fonctionnement de l'ouvre-barrière peut causer des blessures, voire la mort.
5. Use the emergency release only when the gate is not moving.
5. Ne déclenchez le dispositif de désaccouplement d'urgence que lorsque la barrière ne bouge pas.
6. KEEP GATES PROPERLY MAINTAINED. Read the user's manual. Have a qualified service person make repairs to gate hardware.
6. ASSUREZ-VOUS QUE LA BARRIÈRE EST CORRECTEMENT ENTRETENUE. Lisez le manuel de l'utilisateur. Confiez la réparation du matériel de la barrière à un technicien qualifié.
7. The entrance is for vehicles only. Pedestrians must use separate entrance.
7. La voie d'accès est réservée aux véhicules seulement. Les piétons doivent utiliser une voie d'accès différente.
8. SAVE THESE INSTRUCTIONS.
8. CONSERVEZ CES INSTRUCTIONS.

UL 325 MODEL CLASSIFICATIONS



CLASS I

Residential Vehicular Gate Operator - A vehicular gate operator (opener or system) intended for use in a home of one to four single family dwellings, or a garage or parking area associated therewith.

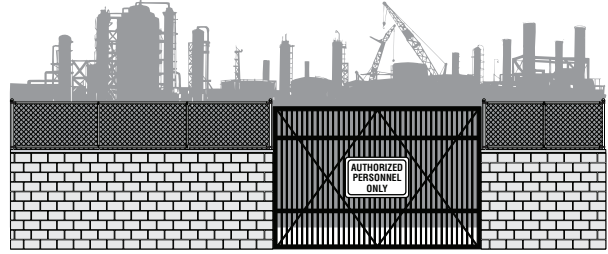

CLASS III

Industrial/Limited Access Vehicular Gate Operator - A vehicular gate operator (opener or system) intended for uses in an industrial location, loading dock area or other location not intended to service the general public.

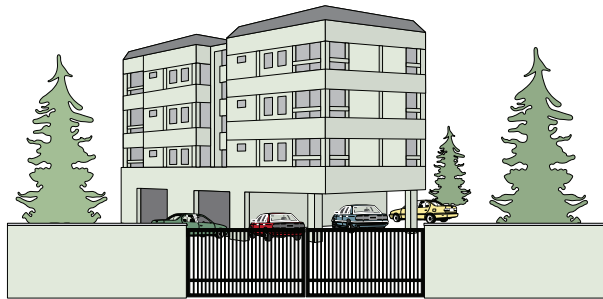

CLASS II

Commercial/General Access Vehicular Gate Operator - A vehicular gate operator (opener or system) intended for use in a commercial location or building such as a multi-family housing unit (five or more single family units) hotel, garages, retail store or other building servicing the general public.

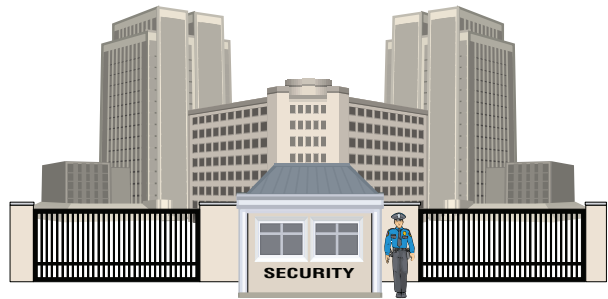

CLASS IV

Restricted Access Vehicular Gate Operator - A vehicular gate operator (opener or system) intended for use in a guarded industrial location or buildings such as airport security area or other restricted access locations not servicing the general public, in which unauthorized access is prevented via supervision by security personnel.

UL 325 REQUIRED ENTRAPMENT PROTECTION

This vehicular gate operator must be installed with at least two independent entrapment protection means as specified in the table and definitions below.

The same type of device shall not be used for both entrapment protection means. Use of a single device to cover both the opening and closing directions is in accordance with the requirement, however, a single device is not required to cover both directions. This operator has been provided with type A entrapment protection. The installer is required to install additional entrapment protection devices in each entrapment area.

Gate Type	Class I & II	Class III & IV
Swing Gate	A, B1*, B2*, C, D	A, B1*, B2*, C, D
Slide Gate	A, B1*, B2*, D	A, B1*, B2*, D

A - Inherent entrapment protection system.

B1 - Provision for connection of a non-contact sensor (photoelectric sensor or the equivalent).

B2 - Provision for connection of a contact sensor (edge device or the equivalent).

* B1 and B2 means of entrapment protection must be MONITORED.

C - Inherent adjustable clutch or pressure relief device.

D - Provision for connection of an actuating device requiring continuous pressure to maintain opening or closing motion of the gate.

INTENDED USE OF SLIDE GATE OPERATOR

The operator is intended for use on a **VEHICULAR** slide gate **ONLY**. It is intended to be used **WITH** appropriate entrapment protection safety devices and in-ground vehicle loop detection system. Pedestrians **MUST** use a separate entrance.

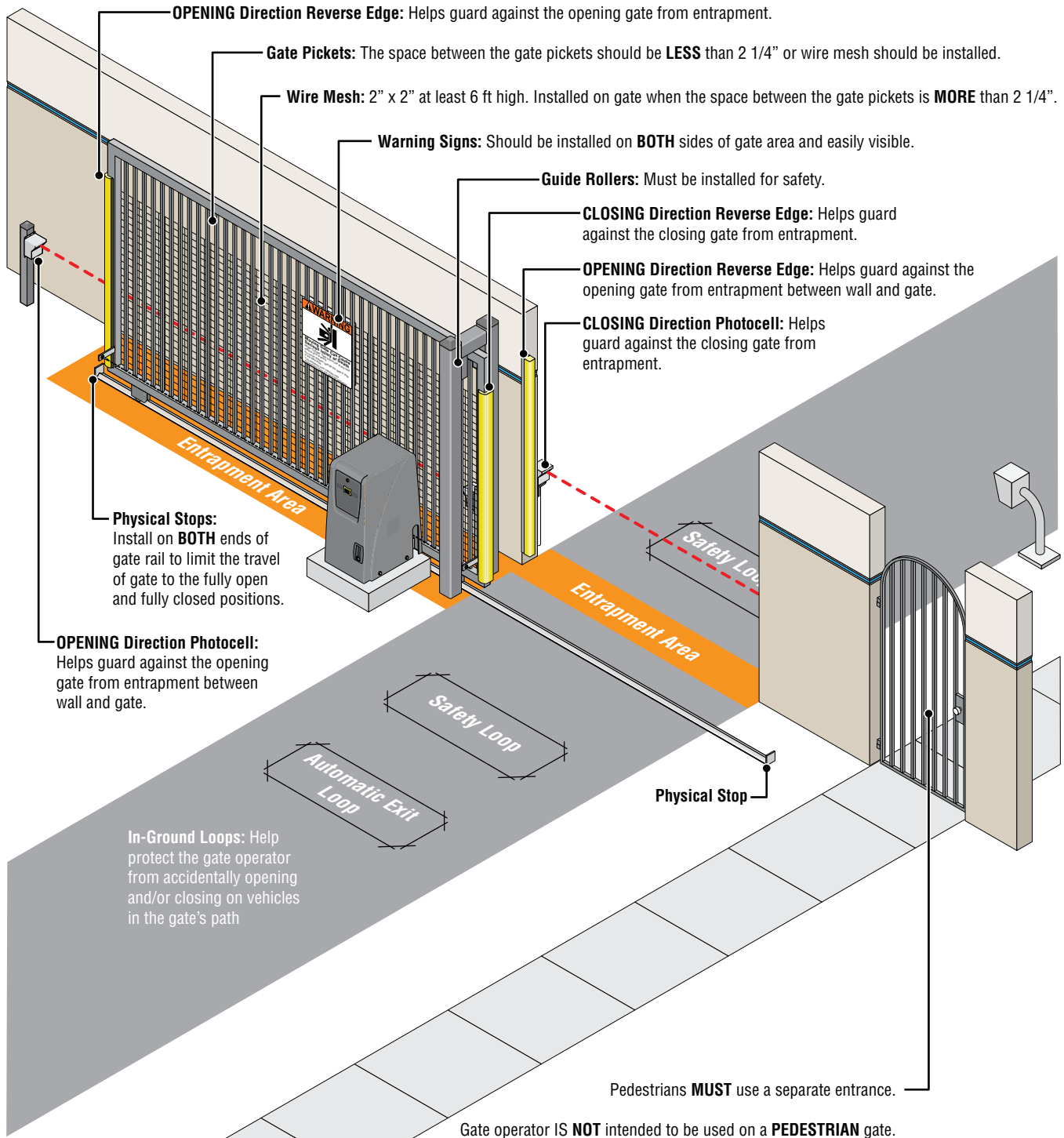

Entrapment sensors must be installed where entrapment or pinch point exist. A minimum of TWO entrapment protection sensors MUST be installed, ONE in EACH direction of gate travel or operator will NOT function.

GATE SAFETY INSTALLATION

Opening Device Requirements

DO NOT install an opening device accessible through the gate. It **MUST** be mounted a minimum of 6 feet away from **ALL** moving parts of the gate and in line-of-sight of the gate. Install it high enough to keep out of reach of small children.

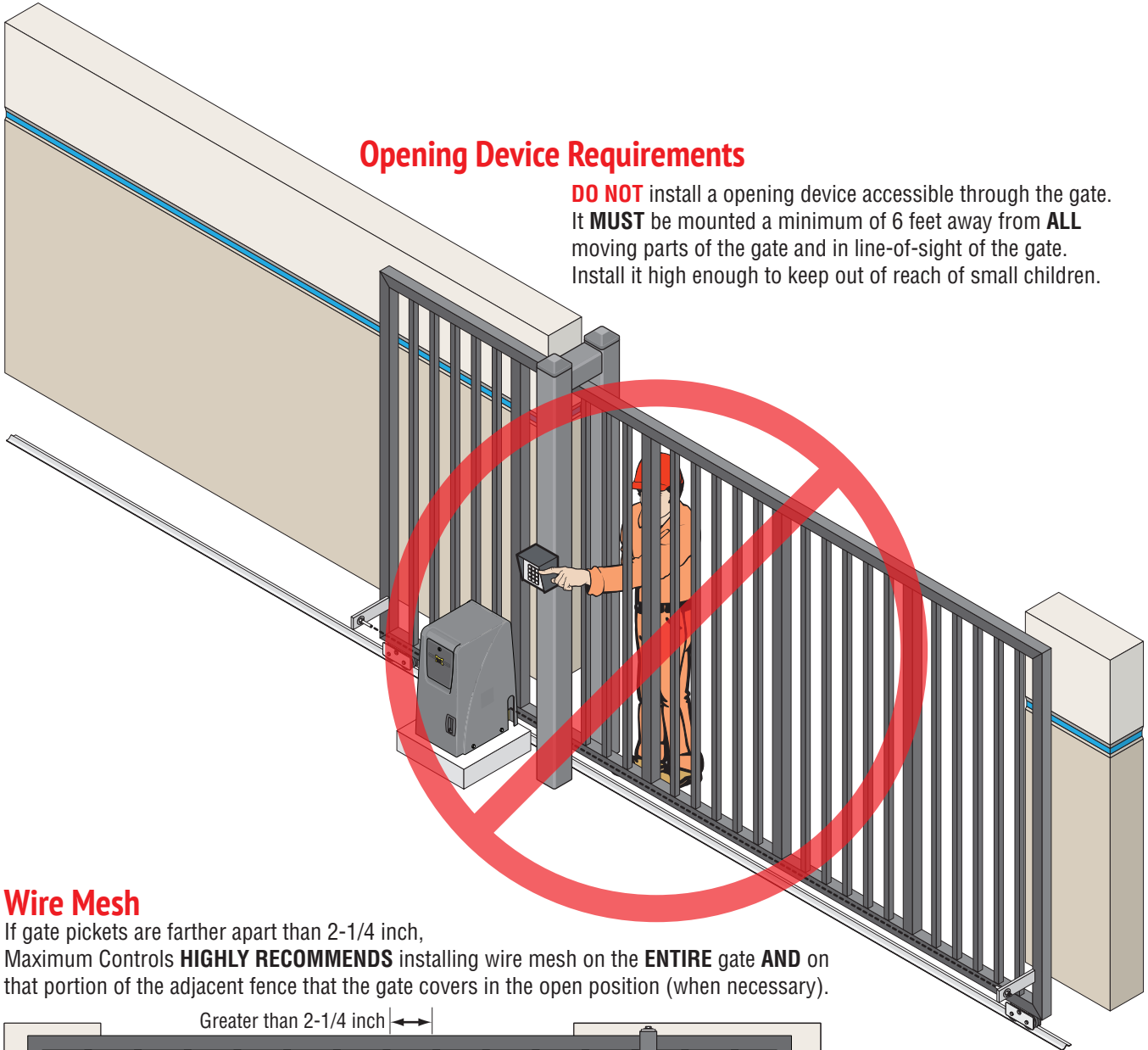

Wire Mesh

If gate pickets are farther apart than 2-1/4 inch, Maximum Controls **HIGHLY RECOMMENDS** installing wire mesh on the **ENTIRE** gate **AND** on that portion of the adjacent fence that the gate covers in the open position (when necessary).

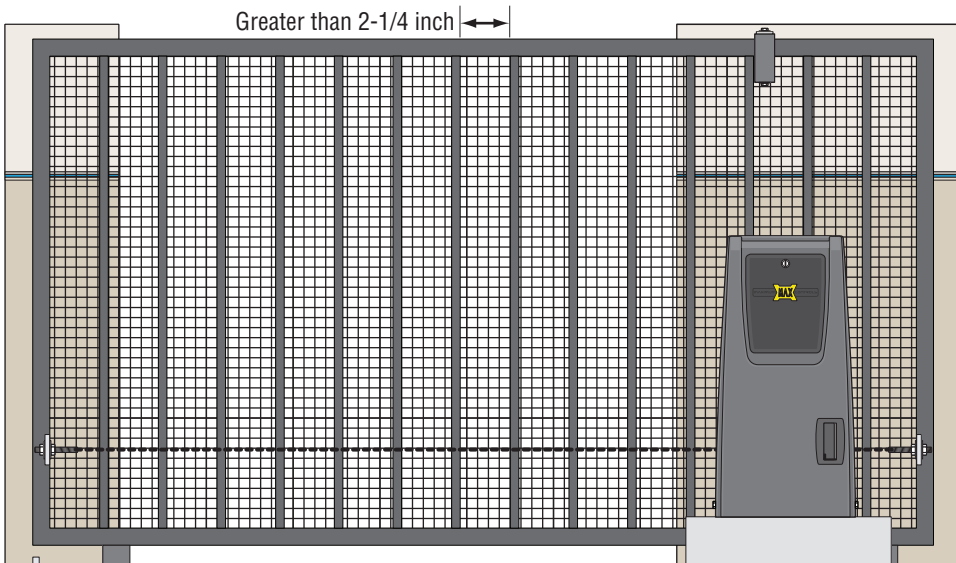

UL 325 Requirements:

All openings of a horizontal slide gate are guarded or screened from the bottom of the gate to a minimum of 6 feet (1.83 m) above the ground to prevent a 2-1/4 inch (57.2 mm) diameter sphere from passing through the openings anywhere in the gate, and in that portion of the adjacent fence that the gate covers in the open position, all exposed pinch points are eliminated or guarded, and guarding is supplied for exposed rollers.

TABLE OF CONTENTS

Gate Safety	Page	Additional Features cont'd	Page
UL 325 Compliant Installation Requirements	Safety-1-3	Partial Open Programming	16
UL 325 Model Classifications	Safety-4	Dropping the Chain - Gate Tamper is Armed (ON)	16
Intended Use of Slide Gate Operator	Safety-5a-5b	Dual Gate Operators Wiring	17
		Gate Disable Feature	18
Step-By-Step Installation		Troubleshooting	
1A Operator Placement (Standard)	1	USB Black Box Port	19
1A Connect Chain to Gate (Standard)	2	Test Entrapment Sensors	19
1B Rear Mounting Position (Alternate)	3	Gate Cycling Troubleshooting	20
1B Connect Chain to Gate (Rear Pos)	4	Matrix III LED Troubleshooting	21-22
2 AC Input Power	5		
3 Ground Operator	6	Commonly Used Safety Sensors	
4 Opening Direction/ID Plug/Operator	6	Omron E3K-R10K4 UL325 POST 2018	23
5 Entrapment Protection Wiring	7-8	Omron E3K-R10K4 UL325 PRE 2018	24
6 Program Virtual Limit Sensors	9	Omron E3K-R10K4 UL325 2018	25
7 Learn Gate Positions	10	EMX WEL-200 Wiring	26
8 Adjust ERD Reverse Sensor	10	WEL-200 Programming	27
9 Loops & Loop Detectors	11	EMX-RET Wiring	28-29
10 Matrix III Settings	11	EMX IRB-MON Single Gate Wiring	30
11 Wiring Opening Device Options	12	EMX IRB-MON Dual	31
12 Learn Unlearned Sensor Inputs	12	Miller RBAND Monitored Wireless	32
		Transmitter Solutions iGaze	33-34
Additional Features	Page	Wiring Overview	35
Programming	13	Optional Magnetic Limit Sensors	36
DIP-Switch Settings	13	Optional Solar Power	37-38
Manual Release Options	14		
Gate Tamper Feature	15		

MAX 1700FS PRO/1200FS PRO SPECS

UL 325 Class of Operation - Class I, II, III, IV

Gate Type - Vehicular Slide Gate

Max Gate Length - 25ft/1200FS PRO, 50 ft/1700FS PRO

Max Gate Weight -1200FS PRO / 1200 lbs Level Gate
1700FS PRO / **1700 lbs Level Gate**

Opening Time - 12 inch per second

Cycles per Hour AC Power - Continuous

Battery Back-Up Cycles (Batteries fully charged) - Approximately 100 cycles

NOTE: The number of gate cycles using **ONLY** battery back-up power will vary depending on the weight of the gate, the gate length, the operating condition of the gate, temperature and the amount of charge the batteries have at the beginning of the battery power only operation.

Input AC Power/Amps - Switchable: 115VAC / 6 Amp, 1 phase
or 230VAC / 2 Amp, 1 phase

Motor: 1200 FS PRO: 1/2 HP 24VDC Brushless (6 million cycles)
1700 FS PRO: 1 HP 24VDC Brushless (6 million cycles)

Chain Size - #40

Operating Temperature: -4°F to 158°F (-20°C to 70°C)

Entrapment Protection:

- UL 325 Type A Inherent (ERD sensor)
- Inputs for **NORMALLY CLOSED (N.C.)** and **10K Type**
UL 325 Type B1 (photo cell)
and Type B2 (sensing edge)

TWO Entrapment protection sensors **MUST** be installed, **ONE** in **EACH** direction of gate travel or operator will **NOT** function.

NOTE: Do NOT use for uphill / downhill gate applications

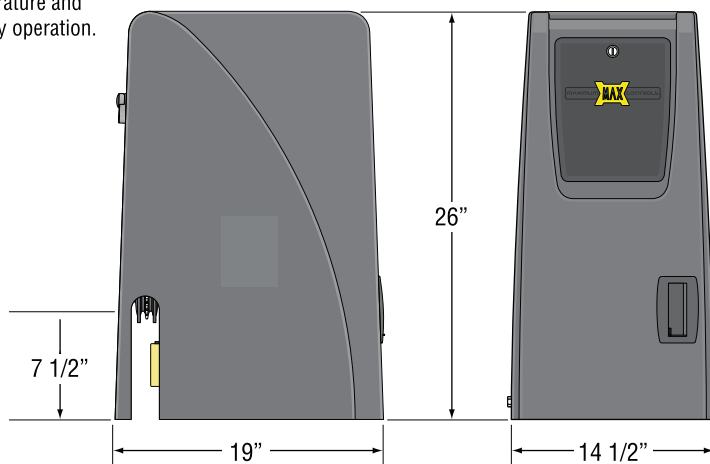
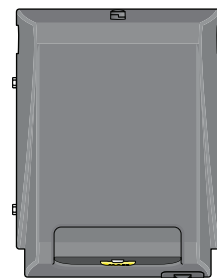

STEP-BY-STEP INSTALLATION

Choose either **1A** Front Mounting Position (Standard) or **1B** Rear Mounting Position (Alternate).

1A OPERATOR PLACEMENT [STANDARD]

The gate must be properly installed and work freely in both directions prior to installation of the gate operator.

Operator in Front Position (Standard)

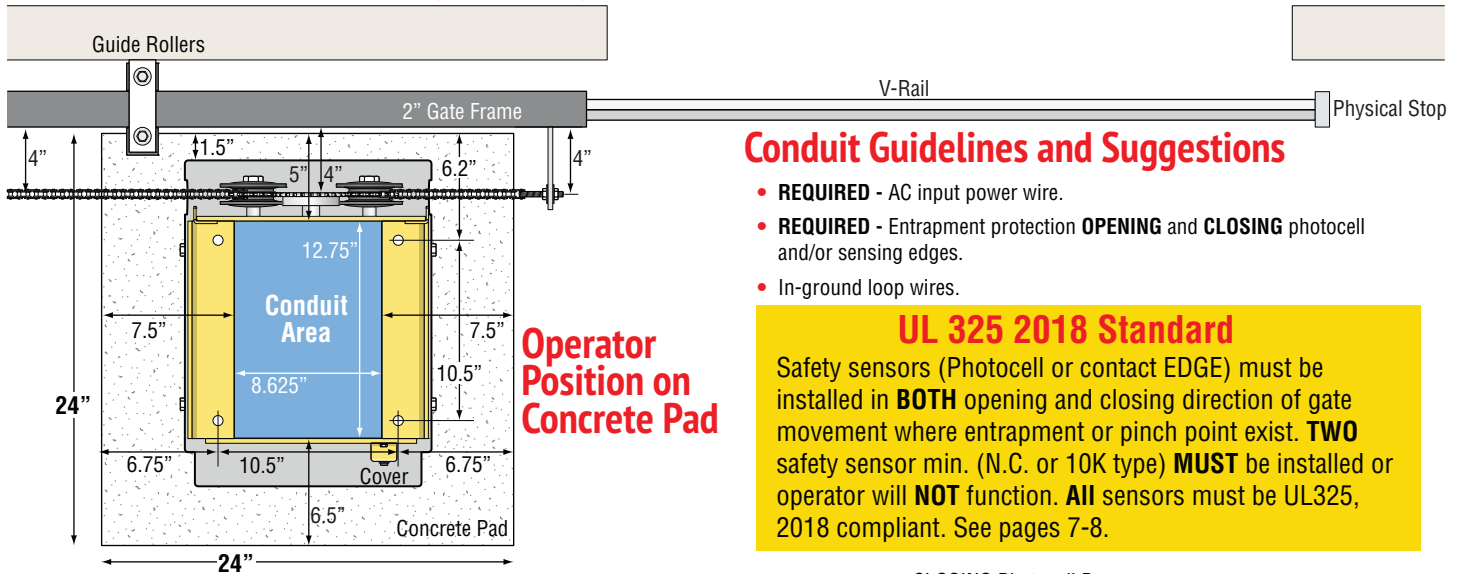

Conduit Guidelines and Suggestions

- **REQUIRED** - AC input power wire.
- **REQUIRED** - Entrapment protection **OPENING** and **CLOSING** photocell and/or sensing edges.
- In-ground loop wires.

UL 325 2018 Standard

Safety sensors (Photocell or contact EDGE) must be installed in **BOTH** opening and closing direction of gate movement where entrapment or pinch point exist. **TWO** safety sensor min. (N.C. or 10K type) **MUST** be installed or operator will **NOT** function. **All** sensors must be UL325, 2018 compliant. See pages 7-8.

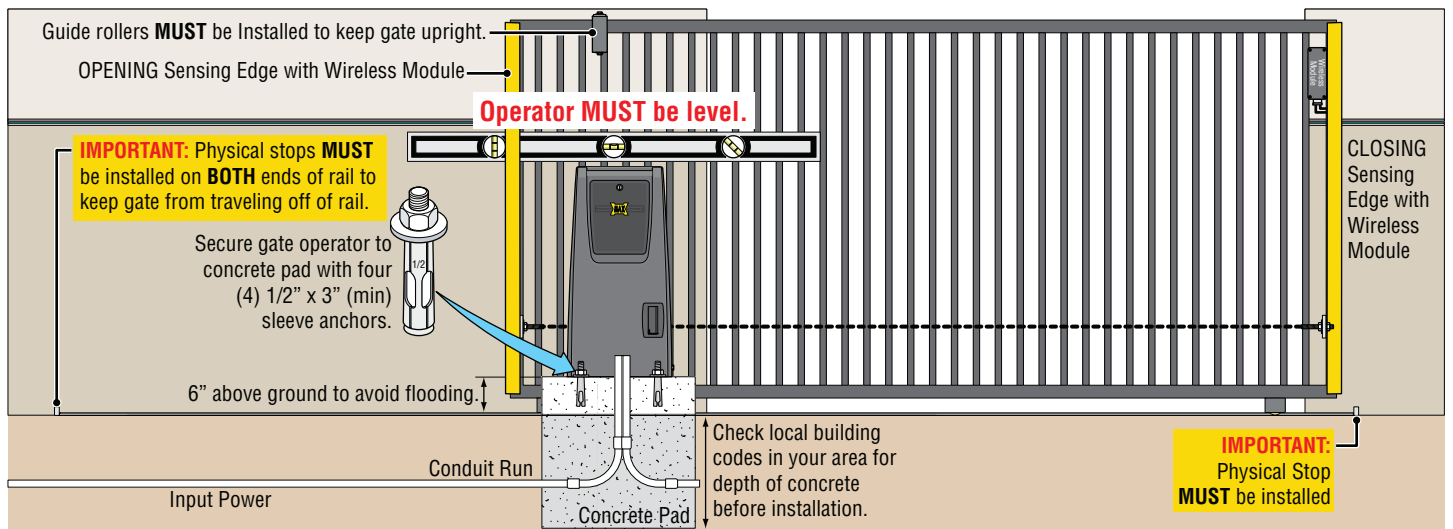
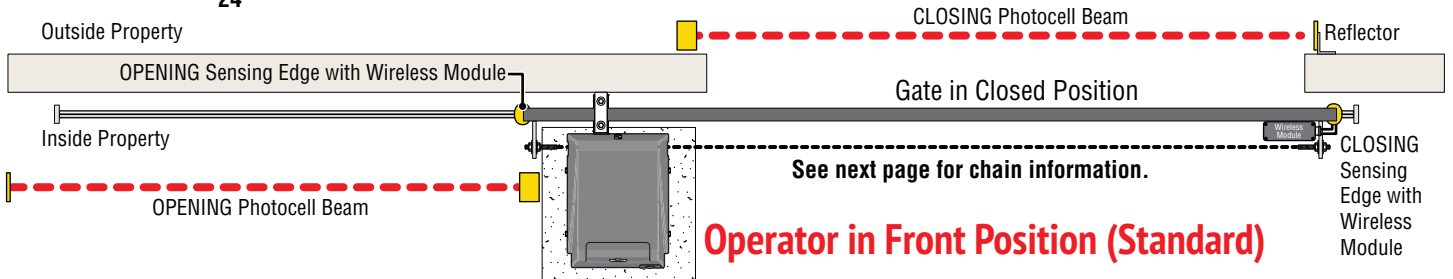

Concrete Depth Note: The heavier the gate, the deeper the concrete pad should be. At least **two feet** recommended for heavier gate.

1A CONNECT CHAIN TO GATE (STANDARD)

Top View of Operator

NOTE: 25 ft of #40 nickel plated chain included.

IMPORTANT: Physical stops **MUST** be installed on **BOTH** ends of gate rail to keep gate from traveling off of rail.

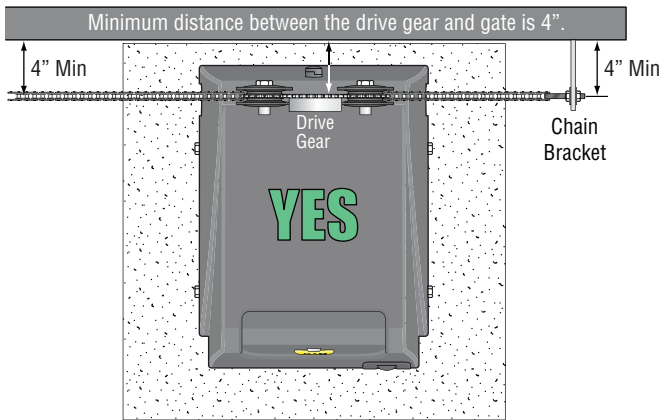

IMPORTANT: Operator and chain **MUST** be parallel to gate or the idler wheels could fail. Use the "Fine Tune" adjustment on the gate bracket connection bolt and make sure the chain runs through the idler wheels **without binding** on the side chain guides.

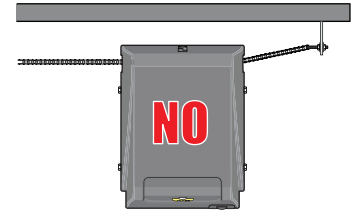
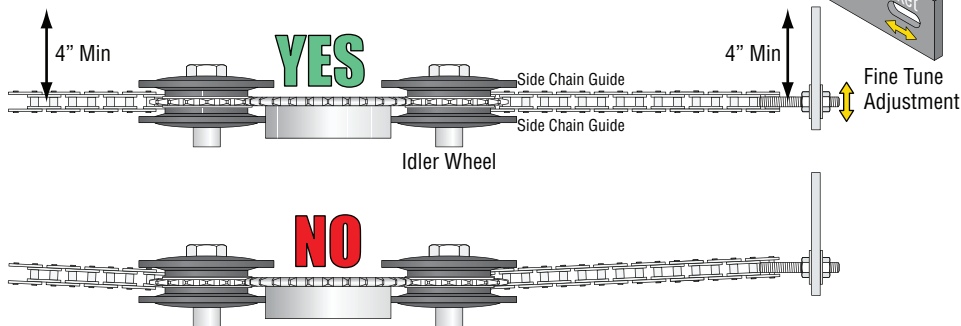

Operator is too far from gate.
Chain is NOT parallel to gate.

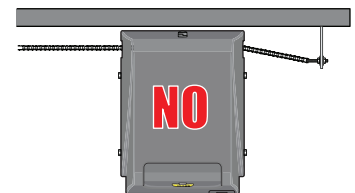

Operator is too close to gate.
Chain is NOT parallel to gate.

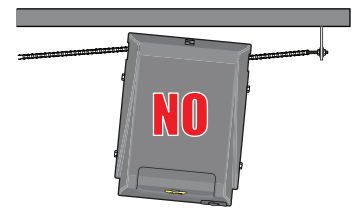

Operator is NOT parallel to gate.
Chain is NOT parallel to gate.

Back View of Operator

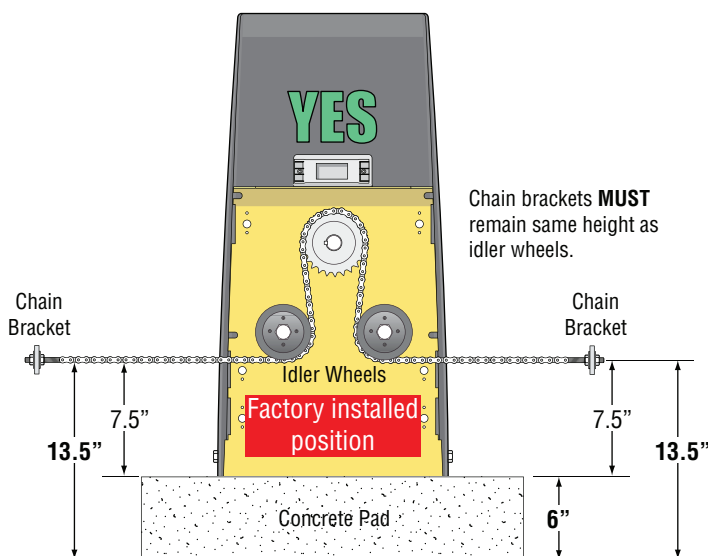

NOTE: The chain should sag no more than one (1) inch per 10 feet of travel. **Do not over tighten the chain.**

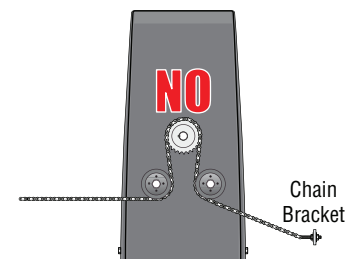

DO NOT mount chain bracket too low on gate.

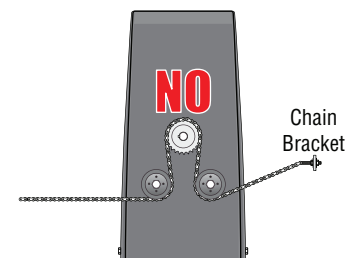

DO NOT mount chain bracket too high on gate.

Operator in Front Position (Standard)

1B REAR MOUNTING POSITION (ALTERNATE)

The gate must be properly installed and work freely in both directions prior to the installation of the gate operator. The chain is not visible when looking from outside of the property.

Conduit Guidelines and Suggestions

- **REQUIRED** - AC input power wire.
- **REQUIRED** - Entrapment protection **OPENING** and **CLOSING** photocell and/or sensing edges.
- In-ground loop wires.

UL 325 2018 Standard

Safety sensors (Photocell or contact EDGE) must be installed in **BOTH** opening and closing direction of gate movement where entrapment or pinch point exist. **TWO** safety sensor min. (N.C. or 10K type) **MUST** be installed or operator will **NOT** function. **All** sensors must be UL325, 2018 compliant. See pages 7-8.

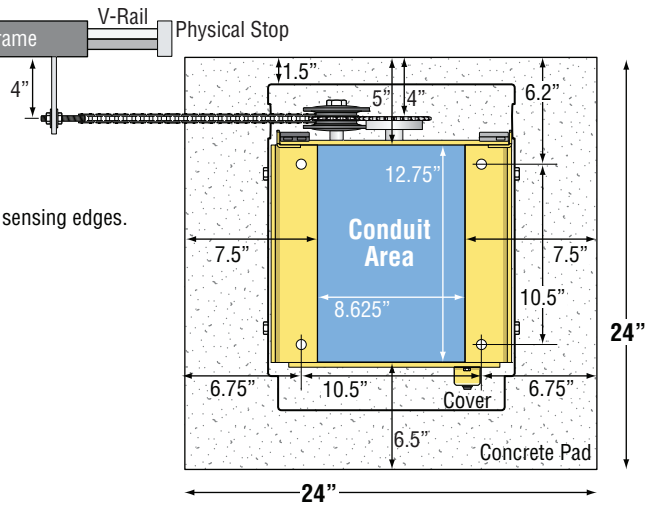

Operator Position on Concrete Pad

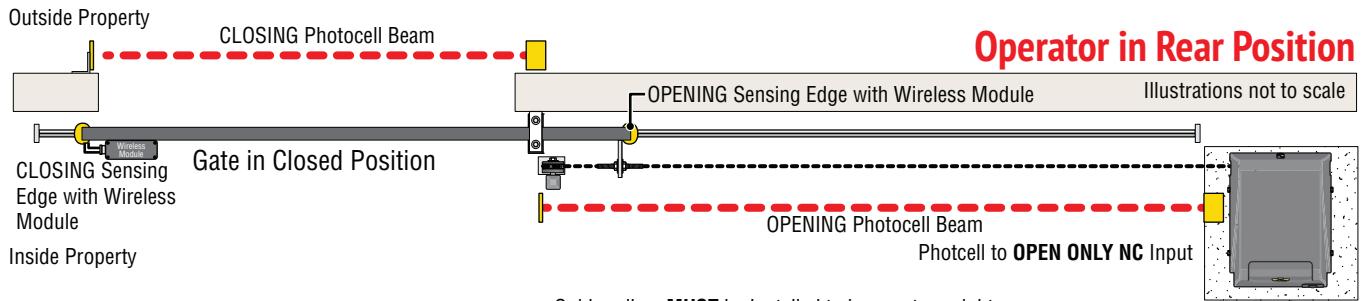

Operator in Rear Position

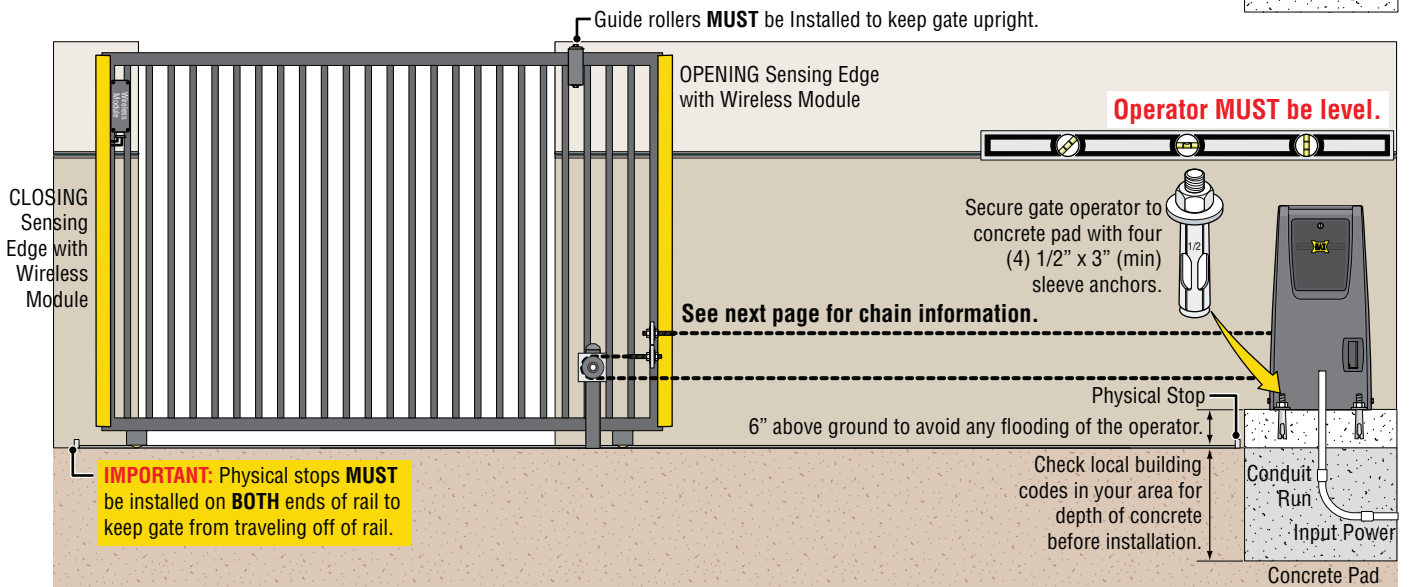

IMPORTANT: Physical stops **MUST** be installed on **BOTH** ends of rail to keep gate from traveling off of rail.

Concrete Depth Note: The heavier the gate, the deeper the concrete pad should be. At least **two feet** recommended for heavier gate.

1B CONNECT CHAIN TO GATE (REAR POS)

Top View of Operator

NOTE: 25 ft of #40 nickel plated chain included.

IMPORTANT: Physical stops **MUST** be installed on **BOTH** ends of gate rail to keep gate from traveling off of rail.

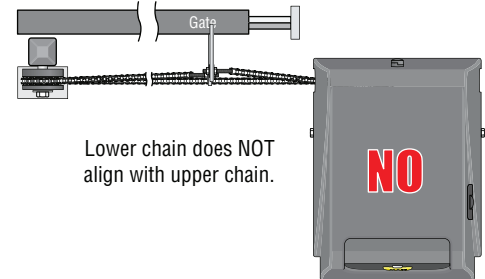
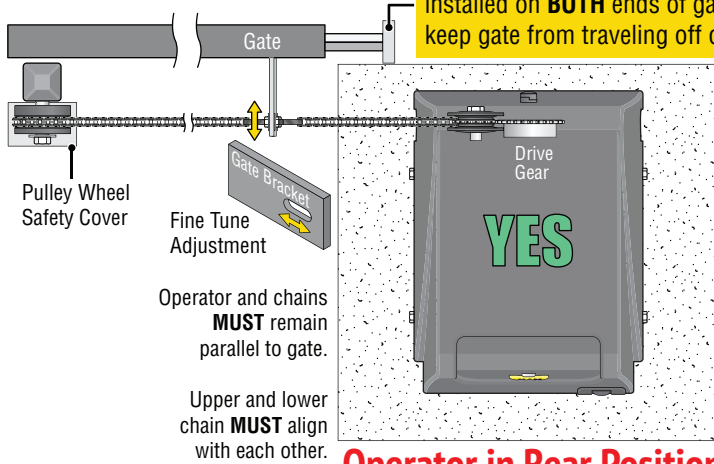

Operator in Rear Position

Back View of Operator

NOTE: The chain should sag no more than one (1) inch per 10 feet of travel. **Do not over tighten the chain.**

IMPORTANT: Operator and chain **MUST** be parallel to gate or the idler wheels could fail. Use the "Fine Tune" adjustment on the gate bracket connection bolt and make sure the chain runs through the idler wheels **without binding** on the side chain guides.

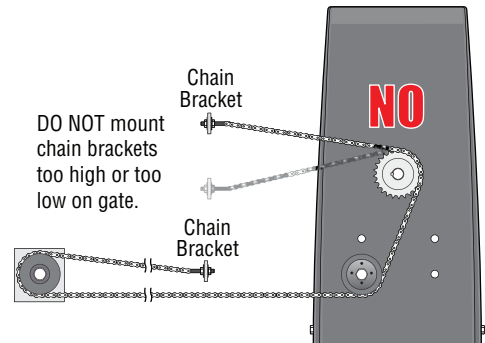
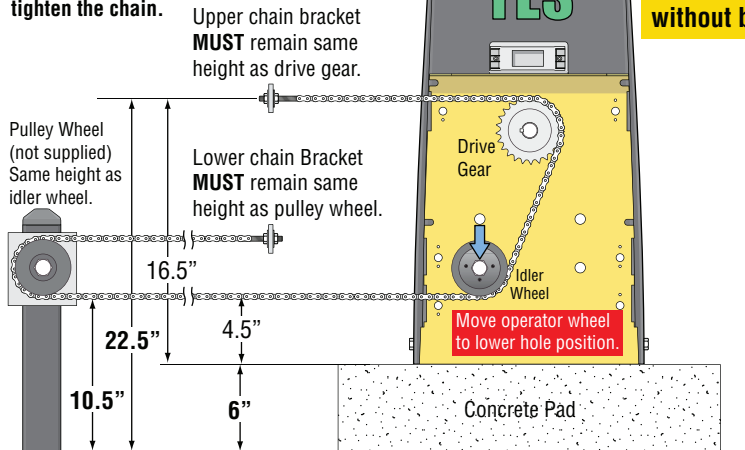

Modify Cover for Rear Mounting Position

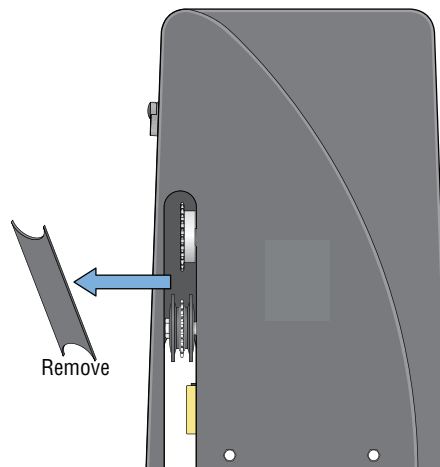
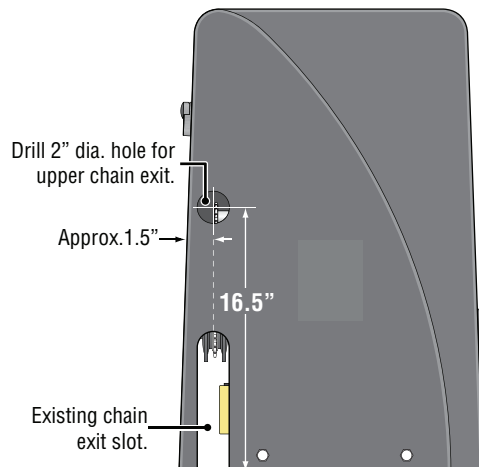

Cut out cover between new hole and existing chain exit slot.

Make sure cuts are plumb with existing chain exit slot.

2 AC INPUT POWER

Choose either **115V** or **230V** setting on input **AC power selector switch**.

Wire desired input AC power wire to power terminal. An additional single gang box with outlet is provided for service use only.

CAUTION: Make sure circuit breaker is **OFF** from incoming AC input wire **BEFORE** wiring!

Input AC Power Options

CAUTION: If input AC power selector switch is set for **115V** but input power is actually **230 V**, 7 Amp Fuse will blow.

Single Phase 115VAC Only

115VAC

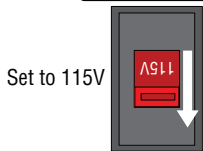

115 OR 230VAC Power Wire

Single Phase 230VAC Only

230VAC



Turn Power ON

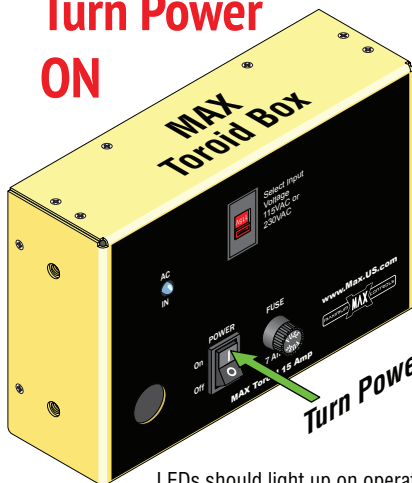

LEDs should light up on operator. Battery power **automatically** turns ON.

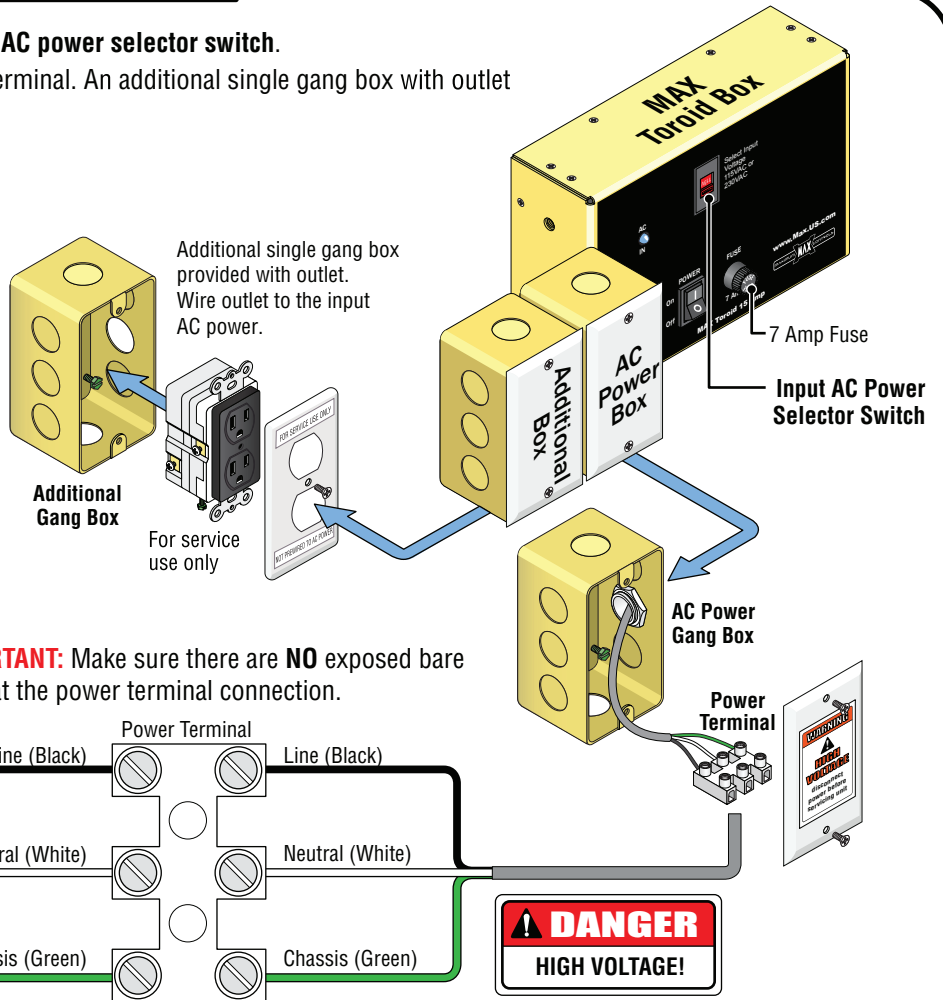

Turn ALL Power OFF

- 1 Turn **OFF** AC POWER switch on MAX Toroid box. Battery power will remain **ON**.
- 2 Press and **HOLD** Red ON/OFF BATTERY button on the board until **BEEP** is heard, release button.

IMPORTANT: This procedure must be followed whenever **ALL** power must be turned **OFF** on operator.

DO NOT CYCLE OPERATOR!

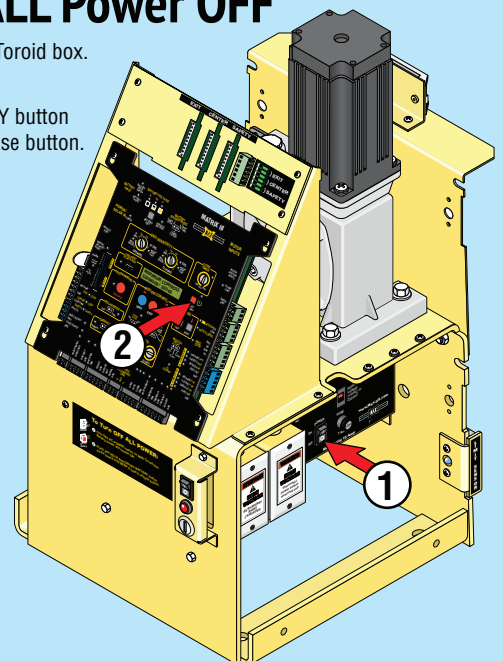

3 GROUND OPERATOR

Operator MUST be Properly GROUND

IMPORTANT: Operator MUST be grounded in lightning prone areas or warranty will be **VOIDED!**

WARNING
connect chassis to ground rod for lightning protection

Proper grounding of this gate operator is a requirement for **LIGHTNING PROTECTION** in lightning prone areas. To be effective, ground connections should be made with a **minimum 12 AWG, 600 volt** insulated wire to a ground point within **3 feet** of the gate operator. The ground point must be at an **electrical panel**, a **metallic cold water pipe** that runs in the earth, or a **grounding rod**.

NOTE: Consult city codes for AC line wiring. Beware of existing underground services.

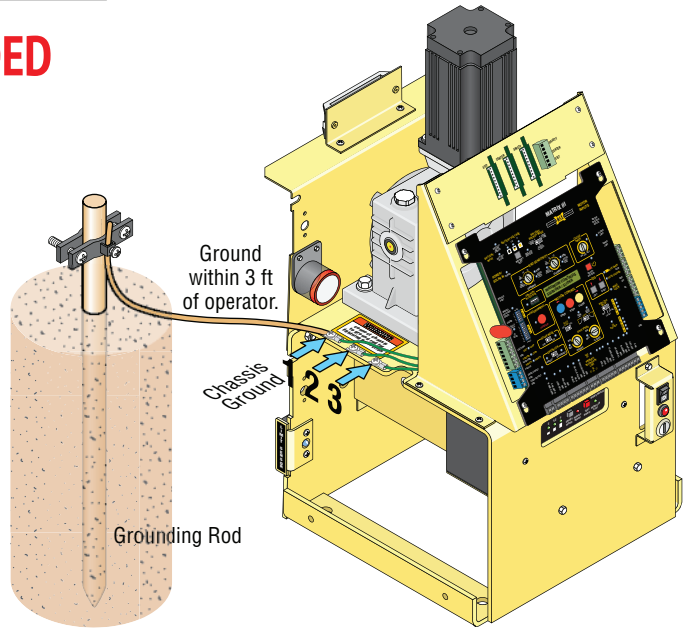

Any of the **THREE** Chassis Grounds can be used. They are located next to the gear reducer. **DO NOT** remove any existing green ground wires.

4 OPENING DIRECTION / ID PLUG / OPERATOR

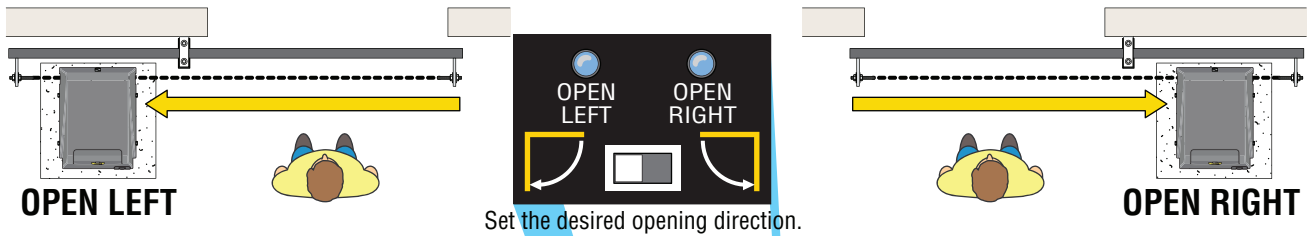

Set the desired opening direction.

ID Plug Error: If ID plug is **NOT** plugged in, board will constantly beep and operator will **NOT** function.

ID plug **MUST** be plugged in.

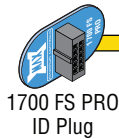

1700 FS PRO ID Plug

Operator:

Set operator to **PRIMARY** for a single operator installation. Set **EACH** Matrix III board for desired operator positions when bi-parting gates are installed.

NOTE: PRIMARY board settings will override secondary board settings if a conflict in settings occurs.

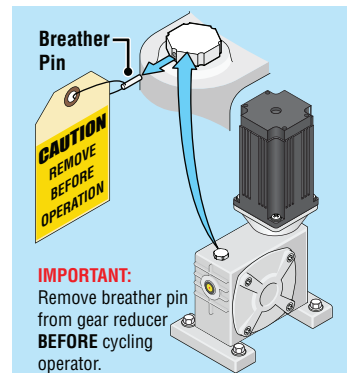
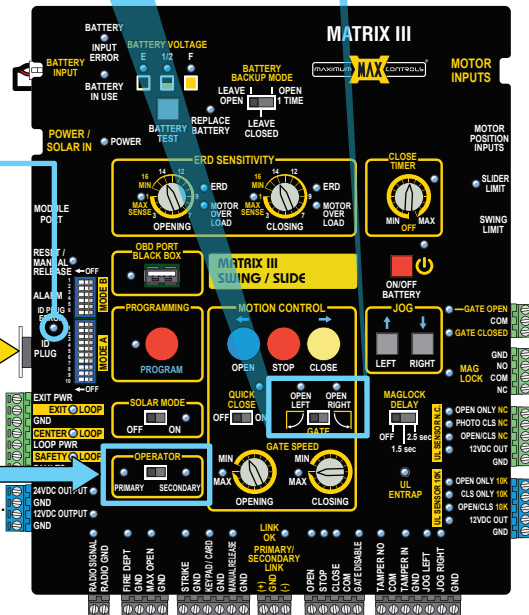

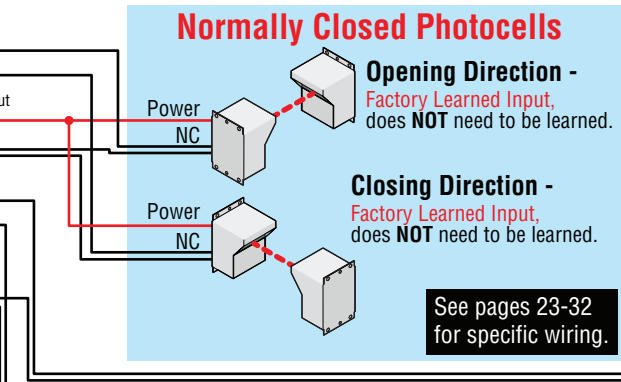
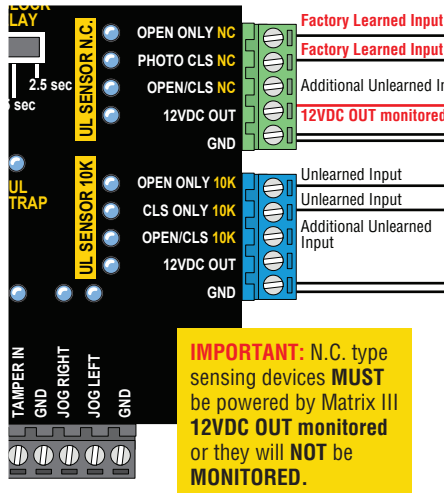

Bi-Parting Gates NOTE: Connect sensors to **EITHER** operator when using dual gates.

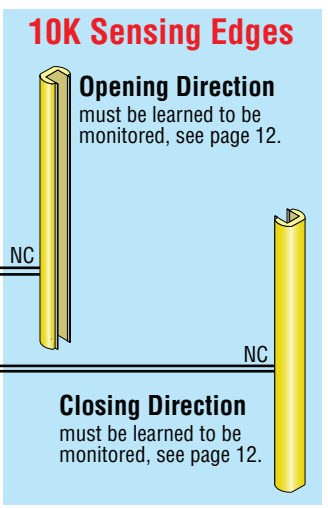

Learned Inputs NOTE: Connect sensors will function when they are **NOT** learned but they will **NOT** be **MONITORED** and **NOT** recommended.

Entrapment Protection Device Options and Locations:

UL 325 2018 Standard
 A minimum of **TWO** entrapment protection sensors **MUST** be installed, **ONE** in **EACH** direction of gate travel or operator will **NOT** function. They **MUST** be **MONITORED** and **NORMALLY CLOSED (N.C.)/10K**. All entrapment zones should be protected by **MONITORED** sensors.

CLOSING Direction Photocell

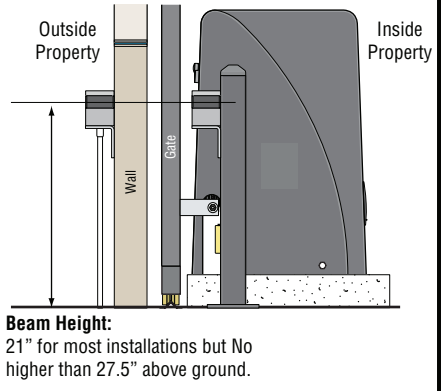
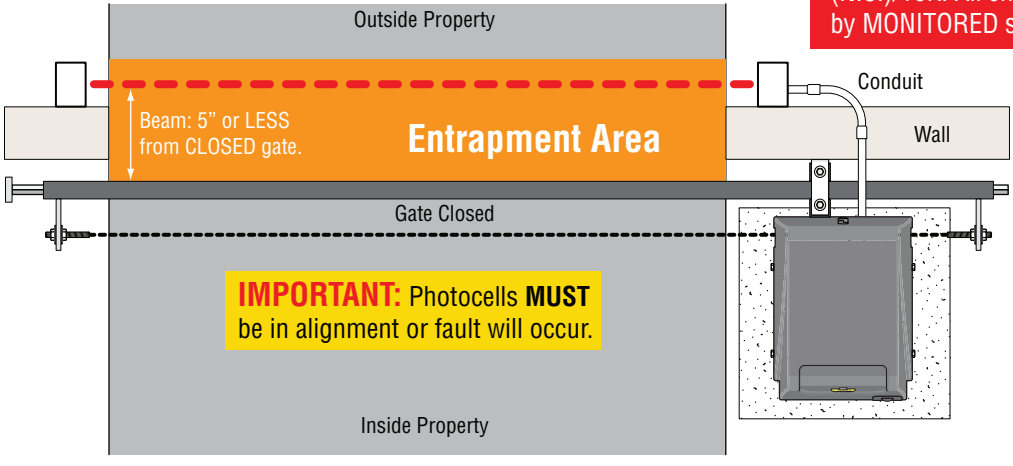

OPENING Direction Photocell

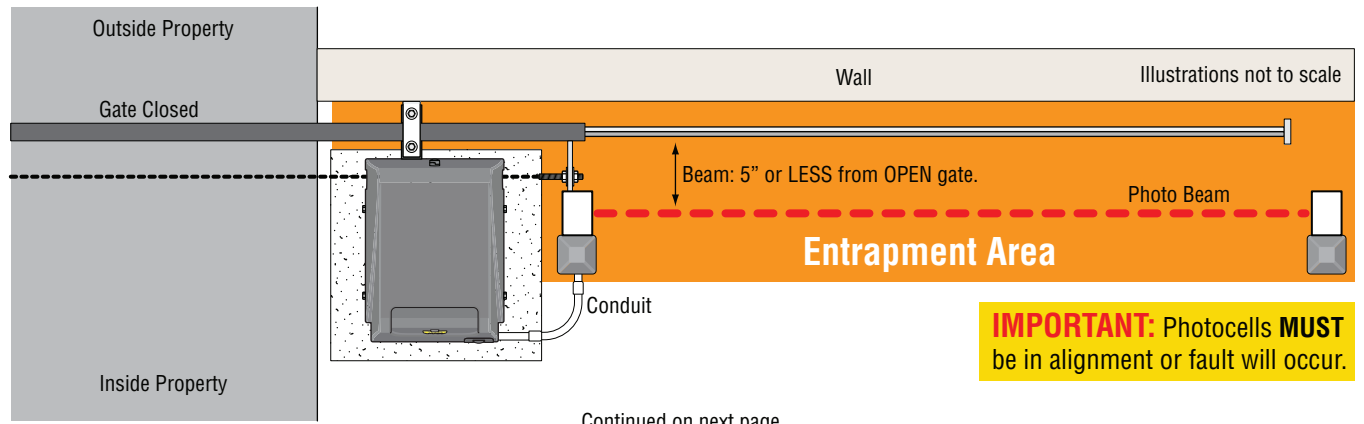

Continued on next page.

Entrapment Protection Device Options and Locations:

Sensing Edges

WIRELESS NOTE: See page 26 OR Refer to the instruction sheet that comes with the wireless module for wiring and mounting instructions when using wireless option.

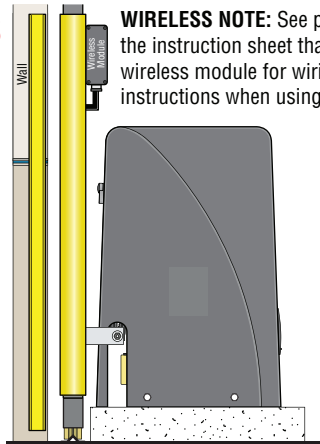

The following is a list of recommended accessories for the MAX Slide PRO Operators.

- Omron E3K-R10K4-10R Photocell
- EMX IRB-MON Photocell (Thru-Beam)
- EMX IRB-RET Photocell (Reflector)
- EMX Wireless Edge Link WEL-200T / WEL-200R
- Enforcer E931-S50RRGQ Photocell (Reflector)
- Enforcer E960-G90GQ Twin Beam (Thru-Beam)
- Miller Edge Prime Guard Photocell (Thru-Beam)
- Miller Edge GEM-104 10K to NC Converter
- Miller Edge R-Band Wireless Edge Unit
P/N: RB-G-RX10 & RB-TX10
- Transmitter Solutions IGAZER50LR-UL Photocell (Reflector)
- Transmitter Solutions IGAZER66HD Photocell (Thru-Beam)
- Transmitter Solutions Wireless Edge Sensor Model: RCO0900
P/N: IGAZERKIT-UL
- ASO Edge MAX Mini Edge Contact Edge Sensor
- ASO Edge Thin Edge MAX Edge 1 Contact Edge Sensor

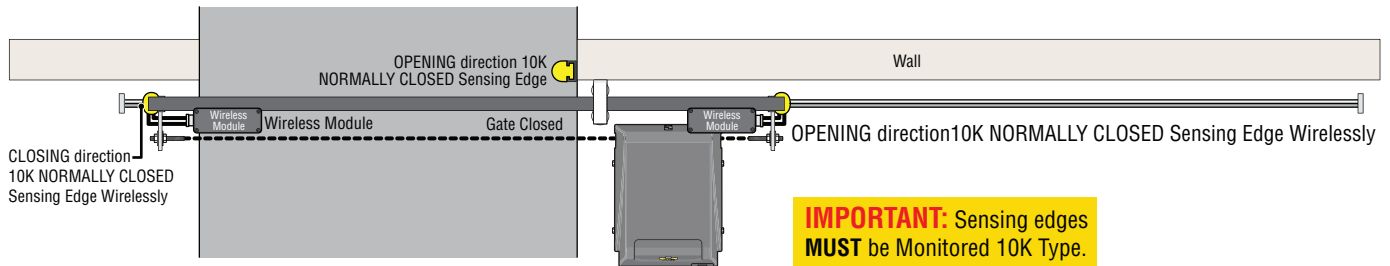

Self-Supporting Post

If a self-supporting post is being used, then sensing edges need to be installed on **EACH** side of the post to protect against entrapment in the **OPENING** and **CLOSING** direction of gate travel.

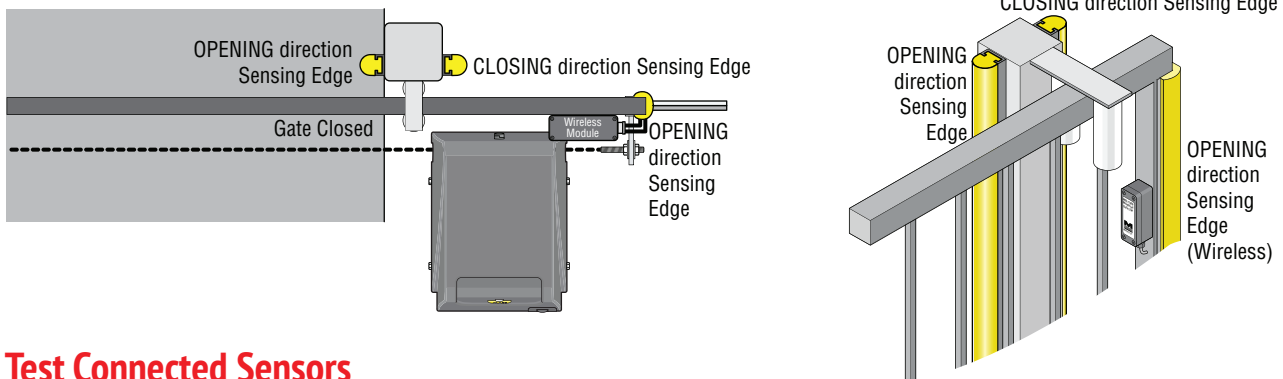

Test Connected Sensors

Test **ALL** connected entrapment protection sensors using learn mode:

- Press and **HOLD** the **STOP** button & then the **OPEN** button together until beeping is heard, learn mode begins.
NOTE: DO NOT press the **OPEN** button before the **STOP** button or learn mode will **NOT** function.

- LEDs should be **ON** for each **connected** entrapment sensor detected. If LEDs are **NOT** on for each connected sensor then they have a problem.
Possible problems:
 - Photocells are out of alignment
 - Photocells are wired wrong - N.C. or N.O. depending on which type of photocells are used
 - Sensing edges are wired wrong - Not 10K type edge sensor
 - Sensor is bad

- Press **STOP** button again within 5 min. to end learn mode, beeping stops.
NOTE: If STOP button is not pressed within 5 min. learn mode automatically end after 5 min.

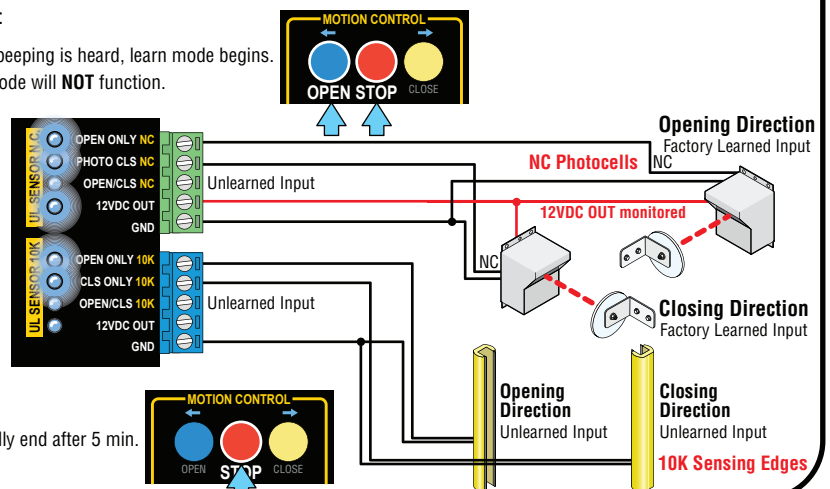

Gate operator OPEN and CLOSE buttons are disabled until virtual limits have been programmed.

If **OPEN** or **CLOSE** buttons are pressed and programming has not been done, Operator will beep and nothing will happen.

IMPORTANT: TO PROGRAM VIRTUAL LIMITS, MAGNET SENSORS MUST NOT BE PLUGGED INTO THE MATRIX 3 BOARD. MAGNET SENSORS PLUG INTO RIGHT SIDE OF THE BOARD towards the top on the **INPUT LABELED** Slider Limit. All Programming should be done on Primary operator.

Make sure the OPEN LEFT - OPEN RIGHT dip switch is set to the correct orientation.

If it is a **DUAL** gate, make sure its set correctly for each operator (primary and secondary.) If the gate is installed in a rear mount configuration, the **OPEN LEFT - OPEN RIGHT** dip switch may be opposite. In this scenario you can check by pressing the jog buttons, for example, if you press jog left and its opening, then the switch should be set to open left.

1. Erase Current Virtual Limits

PRECAUTION: Ensure any previous limits that are set from the factory are erased.

- On **PRIMARY** operator, press and hold **STOP** and **CLOSE** buttons together. (Make sure to press **STOP** before you press **CLOSE**.)
- Once the operator beeps one time, then release the **STOP** and **CLOSE** buttons. (Limits have now been erased.)

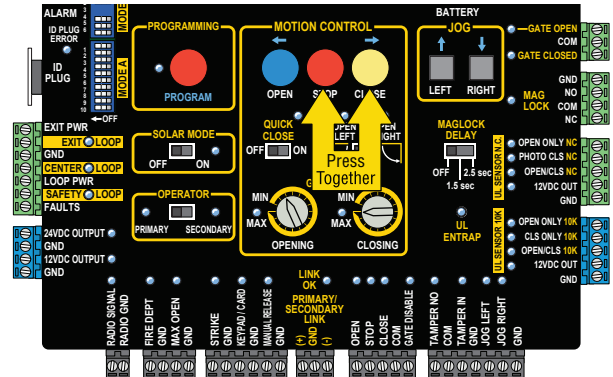

2. Program Virtual CLOSE Limit

- Using the **JOG LEFT** or **JOG RIGHT** Button, move the gate (or gates) to the desired close position.

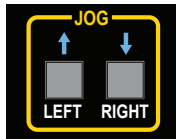

- Press and hold the **PROGRAM** and **CLOSE** buttons together (Make sure that the **PROGRAM** button is pressed before the **CLOSE** button.)
- Once the operator starts beeping (this should take several seconds) release the buttons.
- You should now see the **PROGRAM LED** flash simultaneously with the **GATE CLOSED LED**.
- Now press the **PROGRAM BUTTON** (the close limit(s) are now learned.)

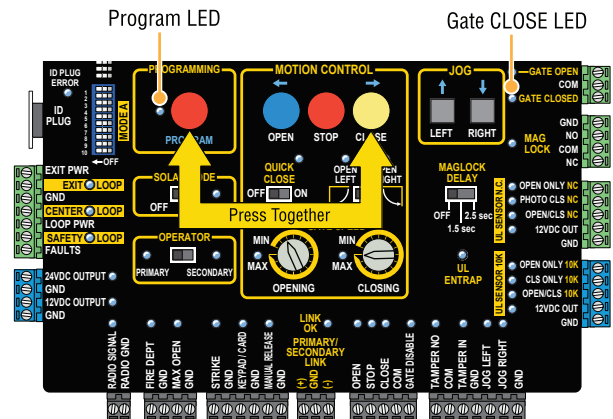

3. Program Virtual OPEN Limit

- Using the **JOG LEFT** or **JOG RIGHT** button, move the gate (or gates) to the desired open position.

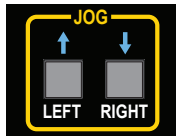

- Press and hold the **PROGRAM** and **OPEN** buttons together (Make sure that the **PROGRAM** button is pressed before the **OPEN** button.)
- Once the operator starts beeping (this should take several seconds) release the buttons.
- You should now see the **PROGRAM LED** flash simultaneously with the **GATE OPEN LED**.
- Now press the **PROGRAM BUTTON** (the **OPEN** limit(s) are now learned.)

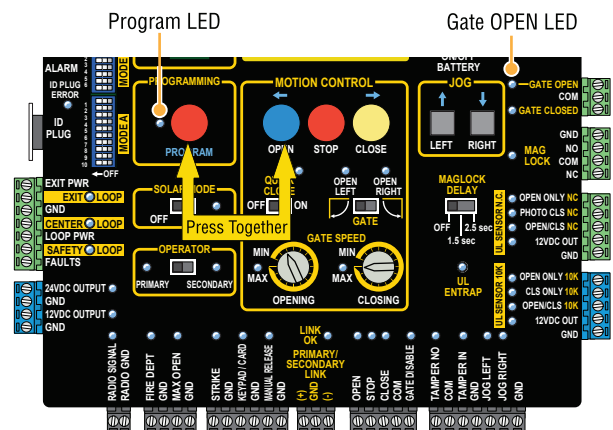

7 LEARN GATE POSITIONS

After the virtual limits have been programmed and at least **ONE** entrapment sensor has been installed in **EACH** direction, put the gate in the **CLOSED** position:

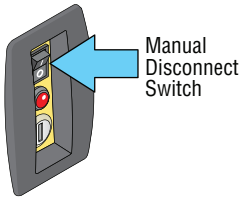

Manual Disconnect Switch

IMPORTANT: Manual Disconnect Switch **MUST** be **OFF**. (see page 14 for more information about switch)

1. Push **OPEN** button to cycle gate to open position. Operator cycles slowly while learning position.

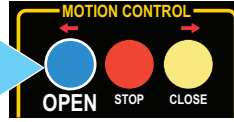

2. Then push **CLOSE** button to cycle gate to closed position. Operator cycles slowly while learning position.

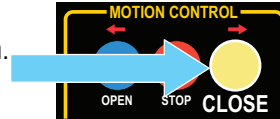

Gate positions have now been learned.

Typically set to MAX, LEDs ON.

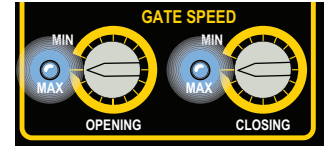

After gate positions have been learned, the gate will cycle at the speed set on "GATE SPEED" settings.

8 ADJUST ERD REVERSE SENSOR

CAUTION: Keep pedestrians and vehicles clear of the gate while adjusting sensors.

The **ERD Sensor - Electronic Reversing Device** (Type A) **MUST** be adjusted for the **OPEN** and **CLOSE** gate cycles.

When the gate encounters an obstruction during the **CLOSE** cycle, it will reverse to the open position and **PAUSE** the gate. An input command (press remote button or exit loop) is needed **BEFORE** the gate will reset and close again.

When the gate encounters an obstruction during the **OPEN** cycle, it will reverse approximately 6 inches and **PAUSE** the gate. An input command (press remote button or exit loop) is needed **BEFORE** the gate will reset and open again.

For the **ERD Sensitivity** to function correctly:

- **Gate positions** must be learned **BEFORE** adjusting the ERD Sensitivity. See above.

16 sensitivity setting positions in EACH direction.
NO mechanical hard stops for knobs.

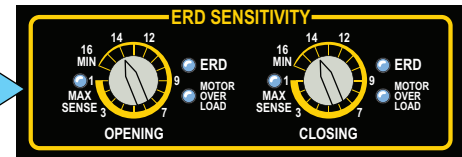

Typical Settings:

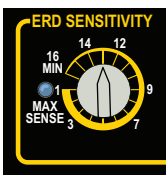

Position 13:
• Typical gate setting.

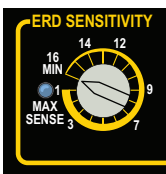

Position 16:
• Heavy gate setting.
• Long gate setting.
• Cantilever gate setting.
• Uphill gate setting.
• High wind area gate setting.

IMPORTANT: When satisfied with ERD adjustment, cycle the gate 3 or 4 times to make sure that the ERD sensor does not **falsely trigger** during normal gate operation. Re-adjust if this happens.

CAUTION: Position 16 results in gate exerting **MAXIMUM force** before reversing direction.

Adjusting ERD in EACH direction:

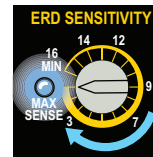

A. Turn knob until blue LED lights up. Maximum sensitivity reached, **Position 1** - Too sensitive for most gates.

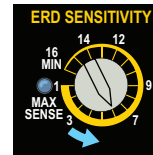

B. Turn knob **counter-clockwise** to reduce gate sensitivity while testing ERD until desired results is attained. (LED remains OFF for all but position 1)

If alarm sounds while adjusting ERD, press **STOP BUTTON** to shut-off alarm.

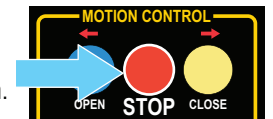

9 LOOPS & LOOP DETECTORS

Loop Detector Rack

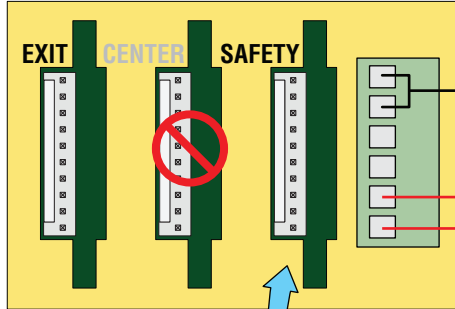

External Loop Detectors

Wire directly to Matrix III board.

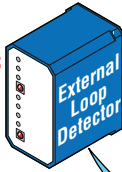

In-Ground Loops

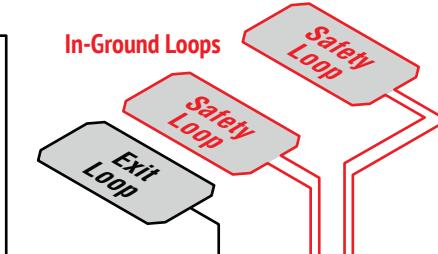

In-Ground Loops Connections

Safety loops wired in series.

Plug-In Loop Detectors

ED1 Loop Detector



ED1 Loop Detector Low Current Draw

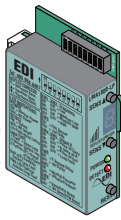

NOTE: DO NOT select the **PULSED** output option for Loop Detectors.

NOTE: DO NOT set Loop Detectors to **HIGH** sensitivity to avoid false trigger.

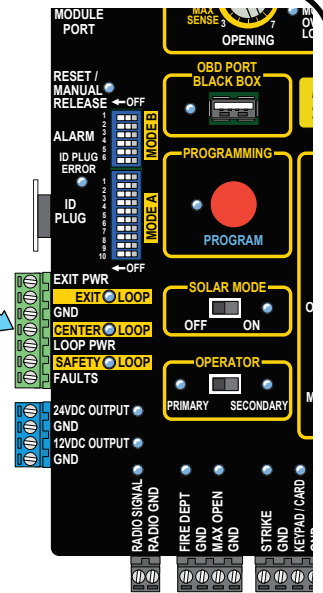

10 MATRIX III SETTINGS

Battery Back-Up Mode

LEAVE OPEN - After a power failure, gate will continue to operate until battery power is drained. At this point, the next open command, gate will remain **OPEN**. Gate will **automatically** close after AC power is restored if close timer is ON.

LEAVE CLOSED - After a power failure, gate will continue to operate until battery power is drained. At this point, gate will remain **CLOSED**.

OPEN 1 TIME - After a power failure, gate **automatically OPENS** and **REMAINS OPEN**. When power is restored, gate will **automatically** close.

Quick Close

Turned OFF - Close timer will close the gate at its selected time.

Turned ON - (In-ground loops required) **OPENING** gate will stop and close after vehicle clears **safety loop**, preventing **UNAUTHORIZED** entry.

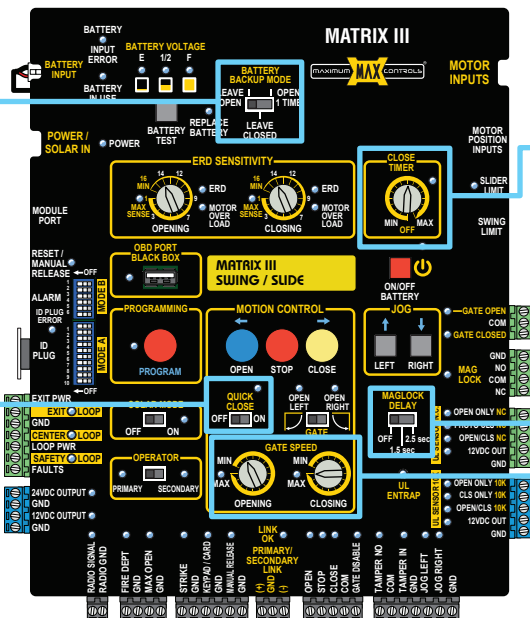

Close Timer

- 1st click clockwise - Knob at MIN: 1/2 sec...
- 2nd click clockwise: 1 sec...
- 3rd click: 4 sec...
- 4th click: 8 sec... etc up to 60 sec. MAX.

Maglock Delay

Set to OFF
See next page to enable this feature.

Gate Speed

After gate positions have been "Learned", the gate will cycle at the speed set on "GATE SPEED" settings.

11 WIRING OPENING DEVICE OPTIONS

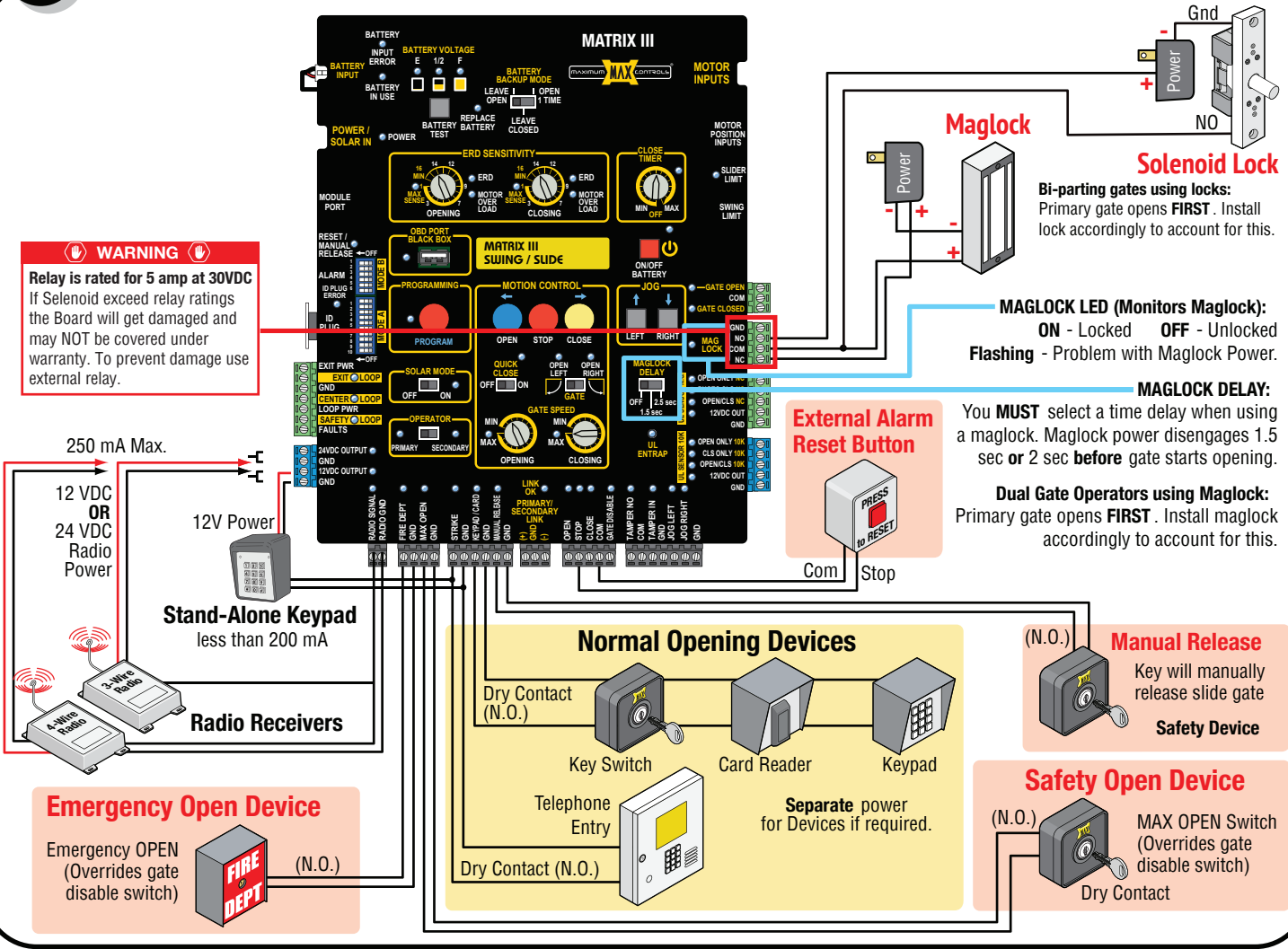

WARNING
Relay is rated for 5 amp at 30VDC
If Solenoid exceed relay ratings
the Board will get damaged and
may NOT be covered under
warranty. To prevent damage use
external relay.

Solenoid Lock
Bi-parting gates using locks:
Primary gate opens **FIRST**. Install
lock accordingly to account for this.

MAGLOCK LED (Monitors Maglock):
ON - Locked **OFF** - Unlocked
Flashing - Problem with Maglock Power.

MAGLOCK DELAY:
You **MUST** select a time delay when using
a maglock. Maglock power disengages 1.5
sec or 2 sec **before** gate starts opening.

Dual Gate Operators using Maglock:
Primary gate opens **FIRST**. Install maglock
accordingly to account for this.

**External Alarm
Reset Button**

Manual Release
Key will manually
release slide gate
Safety Device

Safety Open Device
MAX OPEN Switch
(Overrides gate
disable switch)
Dry Contact

12 LEARN UNLEARNED SENSOR INPUTS

Indicated Inputs **MUST** be "LEARNED" before gate operator will **MONITOR** those sensors.

- Sensors that have been wired to indicated inputs **MUST** be "LEARNED" **BEFORE** they will be **MONITORED**.
 - Press and **HOLD** the **STOP** button & then the **OPEN** button together until beeping is heard, learn mode begins. **DO NOT** press the **OPEN** button before the **STOP** button or learn mode will **NOT** begin (no beeping).
NOTE: Sensors wired to the **PHOTO CLS NC** input and **OPEN ONLY NC** input do **NOT** need to be "Learned". They are "**AUTOMATICALLY MONITORED**".
 - LEDs **WILL** turn **ON** for each detected "**LEARNED**" sensor that has been wired to the inputs. If a sensor's LED is **NOT** on, that sensor has a problem and it **MUST** be corrected before continuing.
Possible problems:
 - Photocells are out of alignment
 - Photocells are wired wrong - N.C. or N.O. depending on which photocells are used
 - Sensor is bad
 When all LEDs are **ON** that should be **ON**, proceed to next step.
 - Press **STOP** button again within 5 min. to learn sensors and end learn mode, beeping stops.
Wired "Learned" Inputs will now be MONITORED.
- NOTE:** If **STOP** button is not pressed within 5 min., learn mode terminates.
If no "**LEARNED**" sensors are detected then factory default setting is restored (Inputs will **NOT** be Monitored).

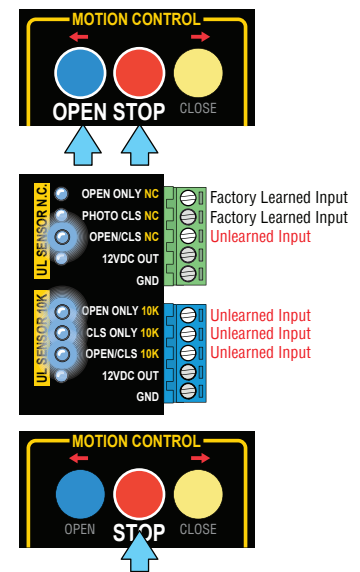

ADDITIONAL FEATURES

PROGRAMMING

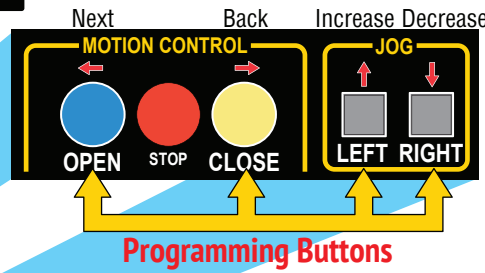
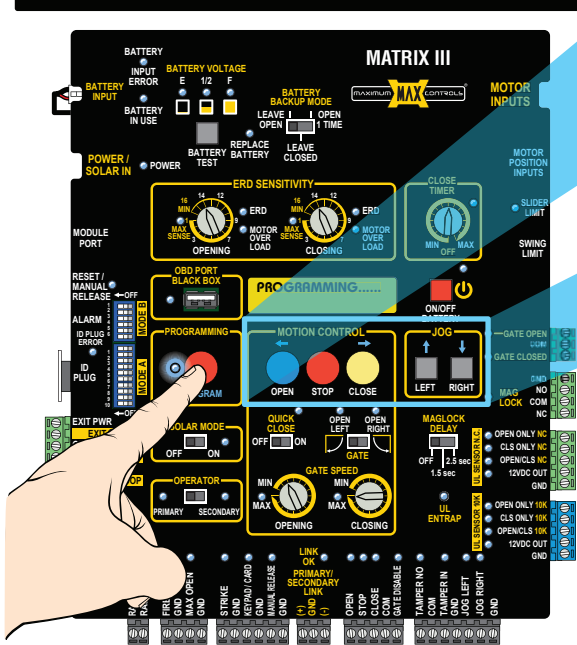

Programming Buttons

To enter **PROGRAM** mode, **press and hold PROGRAM** button for 5 seconds. Follow instructions on-screen using the 4 buttons shown above to program with. Press **ONLY PROGRAM** button **again** to end programming when finished.

In PROGRAM mode, you can do the following:

- Scroll through most recent errors.
- View input voltage (DC voltage).
- View average current gate consumption.
- View cycle count.
- Program date and time.
- Turn on/off other advanced features.

DIP-SWITCH SETTINGS

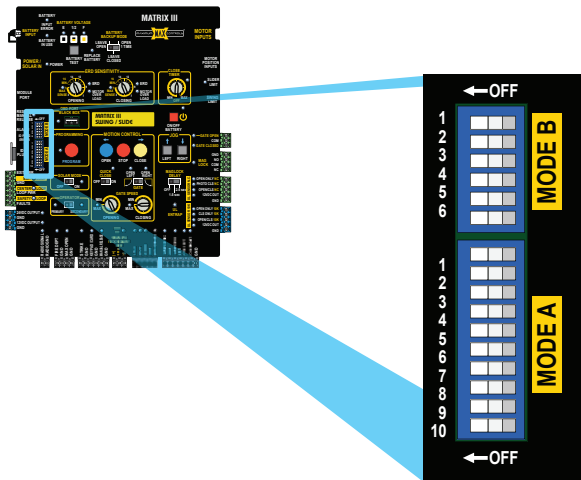

Set desired features using DIP-switches.

Dual Gate Operators NOTE:
Primary operator DIP-switch settings **ONLY**
(settings ignored on secondary Matrix III)

				DUAL GATE APPLICATION PRIM ONLY SETTING	
MODE B Switches	1	Open Relay Pulsed	OFF ON	Open Relay ON when gate open Open Relay Pulsed when gate open	
	2	Solenoid Control Relay	OFF ON	For Maglock: Mag lock relay will trigger BEFORE closed limit is reached. For Solenoid: Mag lock relay will trigger AFTER closed limit is reached.	
	3	Slider Gate Speed 1200/1700 FS	OFF	8 in / sec with (with Drive Sprocket 15 tooth) 12 in / sec with (with Drive Sprocket 23 tooth)	
			ON	12 in / sec with (with Drive Sprocket 15 tooth) 18 in / sec with (with Drive Sprocket 23 tooth)	
	4	No freeze on limit (SLIDER ONLY)	OFF ON	Freeze motor on limit Don't freeze motor on limit, unless back-drive slider	X
	5	MAX RHINO OR	OFF	OFF for MAX RHINO only	
ON			ON for ALL operators (except MAX RHINO)		
6	All other operators	ON	ON for ALL operators (including MAX RHINO)		
MODE A Switches	1	Battery Beep Mode	OFF ON	No beeping when ONLY battery power and gate is in motion. Beeping when ONLY battery power and gate is in motion.	
	2	Gate in Motion Alert	OFF ON	No alarm while gate in motion Alarm while gate in motion	
	3	Strobe Light Control	OFF ON	No strobe light control Strobe light control using Tamper relay N.O./Com	X
	4	Anti-Tailgate	OFF ON	No Anti-Tailgate Anti-Tailgate ON -closing gate will pause if tailgate attempted	X
	5	Close Tamper Detect	OFF ON	No Close Tamper Detect Trigger Tamper Relay (alarm for slider only)	
	6	Stop Input Polarity	OFF ON	Stop Input NO-connect to GND to activate Stop Input NC-disconnect from GND to activate	
	7	Open Relay Polarity	OFF ON	Open Relay CLOSED when gate is open Open relay OPEN when gate is open	
	8	Wireless Pri/Sec Link	OFF ON	Wired Pri/Sec link Wireless Pri/Sec link	X
	9	UL Closing Photo Anti-tailgate (PHOTO CLS NC input)	OFF ON	UL Closing Photo Normal operation UL Closing Photo Anti-tailgate wired to PHOTO CLS NC input ONLY	X
	10	Reserved	OFF ON	MUST be OFF DO NOT turn ON	

MANUAL RELEASE OPTIONS

Local Keyed Manual Disconnect

The dynamic braking system is released for **15 minutes** when switch is turned **ON** and gate can be **manually pushed open**. After 15 minutes, the gate operator returns to normal operation. Turn this switch **OFF** after gate has been moved.

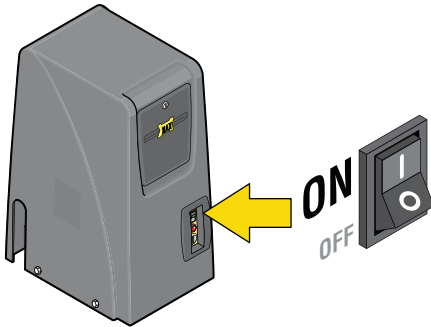

SAFETY FEATURE: If switch is **NOT** turned **ON**, the dynamic braking system, in closed position, will fight back if unauthorized manual opening is attempted.

Note: If switch is **NOT** turned **OFF** after 15 minutes, gate operator returns to normal operation and will not allow gate to be pushed open again. To re-activate the switch when left **ON** after **15 minutes**, turn switch **OFF** then back **ON** again. Gate can be manually pushed open again.

Built-In Electronic Gate Open / Close

The electronic gate open / close is used to disengage the operator's braking system for **15 minutes**. It is connected to the Jog Switch on the motor controller and can electronically open or close gate. See steps below.

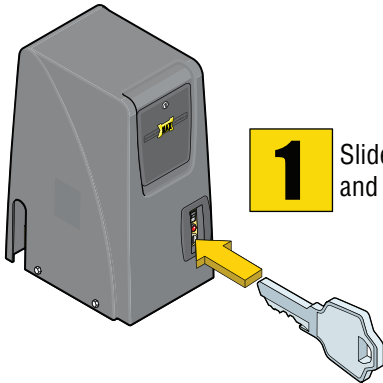

1 Slide door open and insert key.

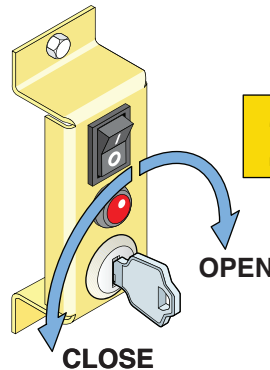

2 Turn and **HOLD** key either way for reversible gate directions.

The **owner** of the gate operator is responsible for the **KEY** availability.

"OPTIONAL" Electronic Gate Open

Allows the gate to be electronically opened. Gate will fully open when activated by key switch or any dry contact command.

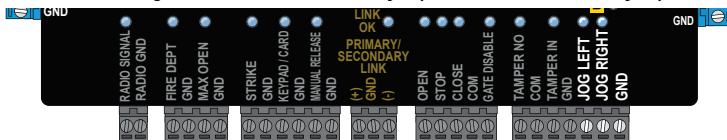

Stand Alone Keypad (Dry Contact) Sold Separately

OR Key Switch (Dry Contact) Sold Separately

Connect to **Jog Right** or **Jog Left** depending on opening direction of gate.

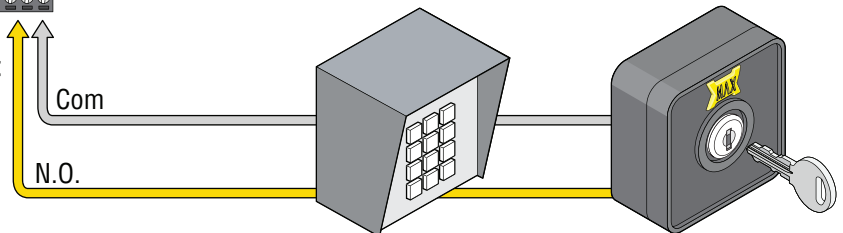

Install inside or outside of property.

Battery Back-Up Settings for Manual Release

When the battery back-up is set to **LEAVE OPEN** or **OPEN 1 TIME**, the operator's braking system will be released allowing the gate to be **manually pushed open** in case of catastrophic failure.

The **LEAVE CLOSED** setting will **NOT** allow the gate to be pushed open unless the **MANUAL DISCONNECT** is turned on when catastrophic failure occurs.

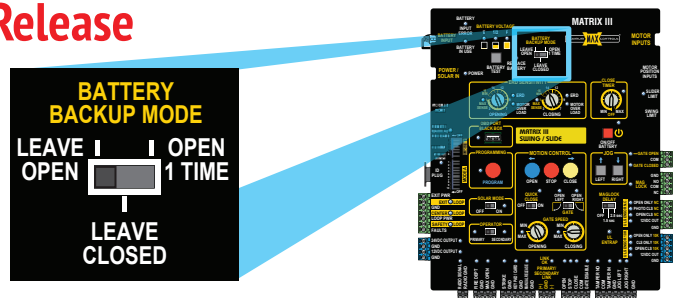

GATE TAMPER FEATURE

Many different safety devices can be wired to the **GATE TAMPER**. After device is wired to relay, it **MUST** be **ARMED** to function.

Wiring Gate Tamper

The **GATE TAMPER** can be used for various functions such as turning a warning light, siren or camera on when the gate is tampered with (Vandalized Gate).

The gate operator defines a "Vandalized Gate" as **UNAUTHORIZED** movement of the gate. This can occur if the chain is dropped and gate is manually moved from the **closed position** or the gate is forced open from the **closed position without authorization**.

TAMPER NO/Com Relay: Connect a warning light, siren, camera or an existing alarm system to relay.

TAMPER IN/GND Input: Connect a sensor device to input. When Tamper In/GND gets triggered, device that is wired to Tamper relay (NO/Com) will activate.

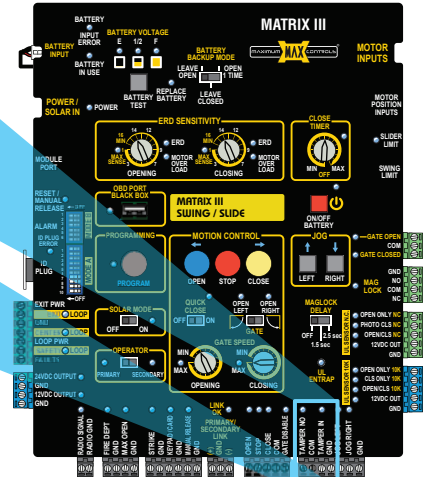
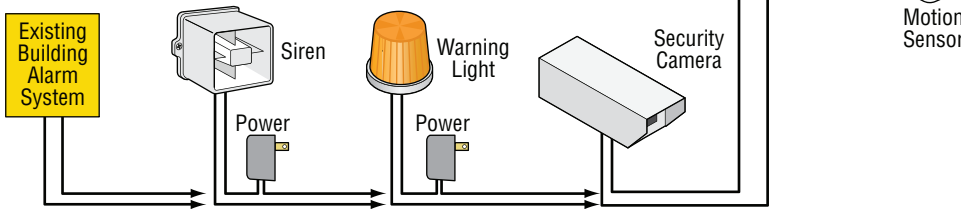

Arm Gate Close Tamper (Turn ON)

The **GATE TAMPER** is factory set to **OFF** (Unarmed). It **MUST** be turned **ON** (Armed) or safety device connected to the **GATE TAMPER** relay will **NOT** activate.

Turn ON 5

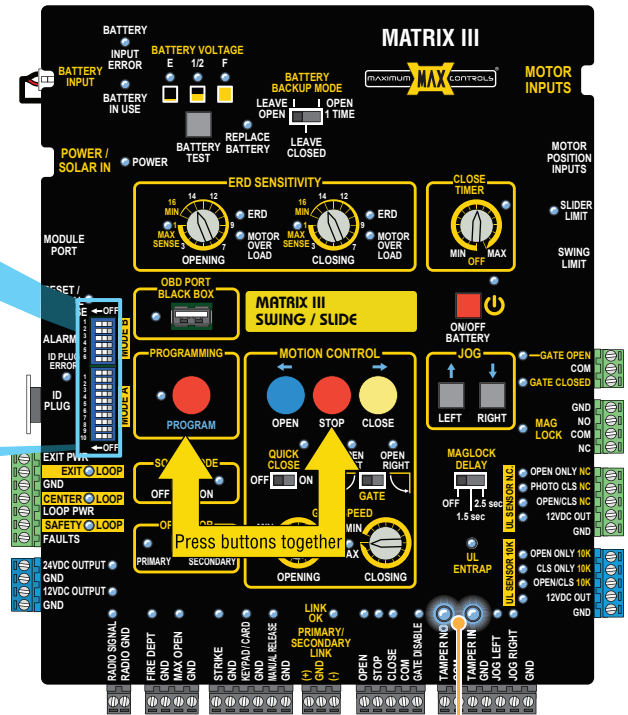
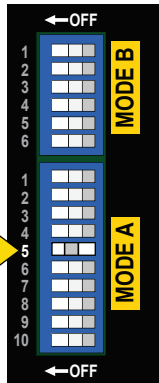

Gate Tamper LEDs

When **GATE TAMPER** is triggered, the **OPERATOR ALARM** and **GATE TAMPER** relay will activate. The operator will shut down all operating functions. The alarm reset button **MUST** be pressed to turn **OFF** the alarm and reset the operator.

If **GATE TAMPER** is armed and relay is connected to an existing building alarm system, then they will get a triggering of their alarm system and should be notified of the situation.

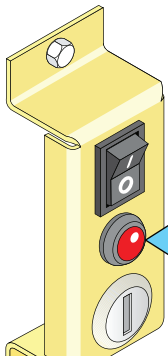

Alarm Reset Button

PARTIAL OPEN PROGRAMMING

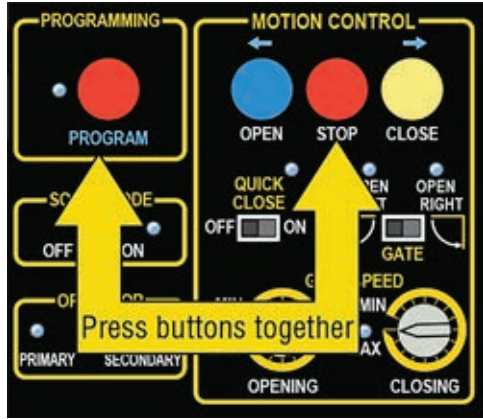

To program partial open position on slider:

Open and close limits must be learned (Virtual limits or magnet sensor limits)

1. Gate must be in closed position.
2. Press and hold STOP + PROGRAM buttons simultaneously for 5 seconds until a beep is heard and program LED starts blinking.
3. Release STOP and PROGRAM buttons
4. Open gate to desired partial open position. (For single gate, open gate minimum 6ft. For dual gate, open gate minimum 4ft.)
5. Press PROGRAM button to record partial open position. (Program LED will stay on when partial open position is programmed.)

To erase partial open: Press STOP + PROGRAM simultaneously for 5 seconds until the program LED turns off. (Gate must be in closed position.)

DROPPING THE CHAIN - GATE TAMPER IS ARMED (ON)



The **GATE TAMPER** is factory set to **OFF** (Unarmed). See previous page for more information about **ARMING GATE TAMPER**.

If an existing alarm system (Building alarm system) is connected to the **GATE TAMPER** relay (see previous page), notify proper authorities **BEFORE** dropping the chain.

Manual Disconnect
Alarm Reset Button

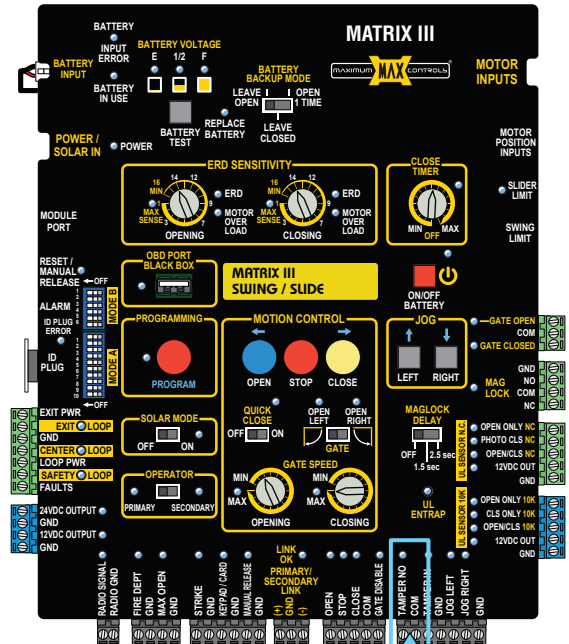

PROPER Dropping of Chain while GATE TAMPER is ARMED:

1. Turn Manual Disconnect **ON** to disable operator alarm.
2. Drop the Chain.
3. **GATE TAMPER** relay **WILL** be activated.
4. Service operator.
5. Reconnect the chain to gate.
6. Turn Manual Disconnect **OFF**.
7. Rearm an alarm system that may be connected to the **GATE TAMPER** relay.



IMPROPER Dropping of Chain (Vandalize):

Manual Disconnect switch is **NOT** turned **ON**.

When the chain is improperly dropped (Vandalized), the **OPERATOR ALARM** and **GATE TAMPER** relay will activate. The operator will shut down all operating functions.

The alarm reset button **MUST** be pressed to turn **OFF** the alarm and reset the operator. If **GATE TAMPER** relay is connected to an existing building alarm system, then they will get a triggering of their alarm system and should be notified of the situation.

DUAL GATE OPERATORS WIRING

Primary Operator

Secondary Operator

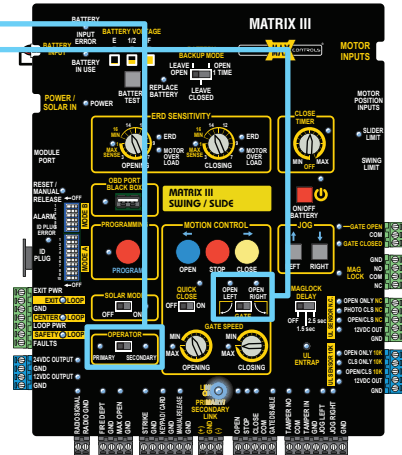
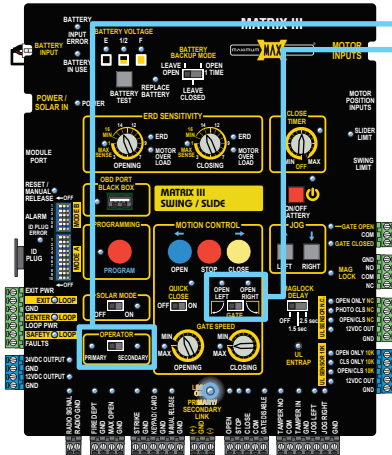

Set one operator to **PRIMARY** and the other to **SECONDARY**.
Set opening directions of each (reverse of each other).

Primary operator Matrix III settings ONLY
(settings ignored on secondary Matrix III):

- Close Timer
- Maglock Overlap Delay
- Battery Backup Mode
- Partial Open Recording
- Solar Mode
- Quick Close - Anti-Tailgate

For **Primary** operator DIP-switch settings **ONLY** refer to the dipswitch table on page 13.

Event History can **ONLY** be viewed and/or downloaded on **PRIMARY** Matrix III.

NOTE: PRIMARY board settings will override secondary board settings if a conflict occurs.

- AC input power run to **EACH** gate operator.
- Entrapment protection devices can be connected to **EITHER** operator.
- **Normal Opening/Security/Maglock** devices can be connected to **EITHER** operator.
- **Jog LEFT/RIGHT** buttons **ONLY** operate the **specific gate** connected to operator.
- **Manual Release** can be initiated from **EITHER** operator but affects **BOTH** operators.
- **Gate Disable** can be initiated from **EITHER** operator but affects **BOTH** operators.
- **Virtual Limit Programming** can **ONLY** occur on **PRIMARY** operator.

LINK OK LEDs should remain **ON** indicating good communication between operators.

Primary RS-485 (+) to Secondary RS-485 (+)
Primary RS-485 (-) to Secondary RS-485 (-)
Primary RS-485 GND to Secondary RS-485 GND

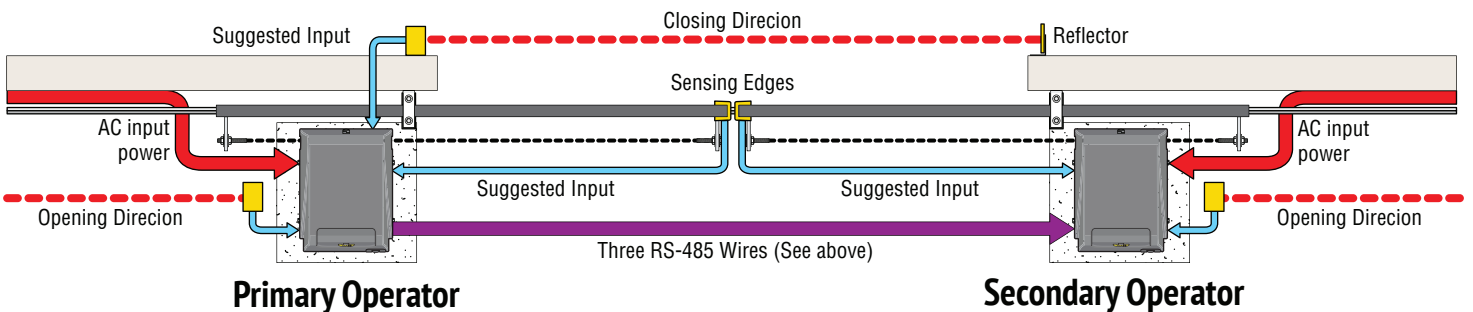

NOTE: The Alarm Shut-Off “STOP” button can be pressed on **EITHER** gate operator.

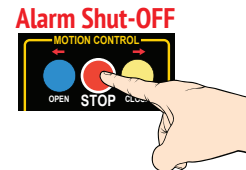

GATE DISABLE FEATURE

This unique **GATE DISABLE** feature is useful when the gated area needs to be secured from **ALL** but emergency and/or authorized vehicle entry. Some examples are:

- Residential home vacation period.
- During closed hours of a business.

The **GATE DISABLE** feature will allow the FIRE DEPT/MAX and RADIO inputs to operate but nothing else. It helps with some major security problems that can occur when no one is available to monitor the property.

GATE DISABLE prevents breaking into a keypad box and trying to trigger the wires to get the gate to open.

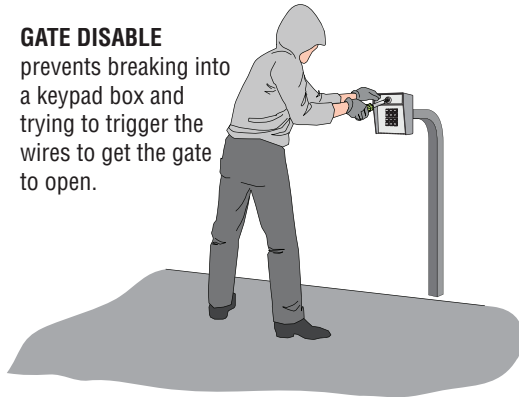

GATE DISABLE prevents trying to trigger the exit loop to get the gate to open.

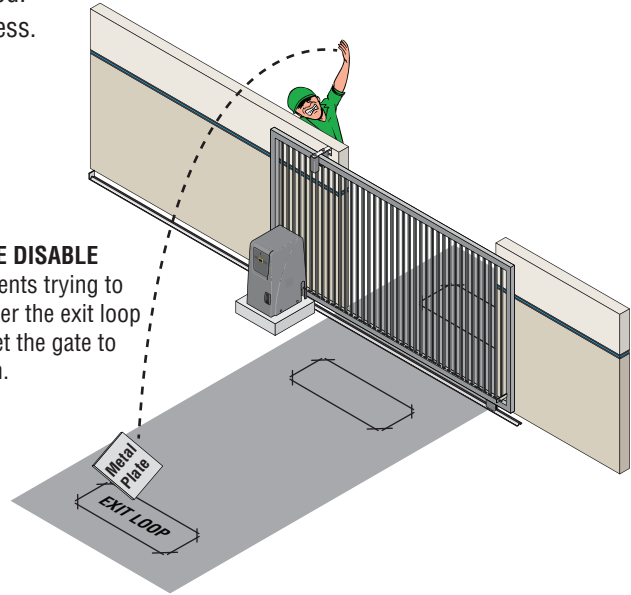

IMPORTANT: It is **NOT** recommended activating **GATE DISABLE** while persons are present inside the property.

Wiring Gate Disable

An ON/OFF switch or 7-Day timer devices can be connected to the **GATE DISABLE** input. When these devices are turned ON, they will **DISABLE** normal opening devices such as keypad, exit loop etc. The **FIRE DEPT/ MAX OPEN** and **RADIO** inputs will remain enabled when **GATE DISABLE** has been turned ON. This is useful when the gated area needs to be secured from ALL but emergency or authorized vehicle entry.

When GATE DISABLE is turned ON: The operator will beep for **3 minutes BEFORE arming itself**. This allows time to turn ON **GATE DISABLE** and leave the property before it is armed.

When FIRE DEPT/MAX OPEN gets activated: Gate opens and **GATE TAMPER** relay will activate immediately.

When RADIO Input gets activated: Gate opens and **GATE TAMPER** relay will activate **after 3 min**. This allows time to turn OFF **GATE DISABLE** or disarm an existing building alarm system if connected.

Operator Shut Off

We have also added the “operator shut off” feature to further protect Max 1200/1700 FS against damage due to conditions such as gate being above capacity, gate binding, or gate getting off the track. This “operator shut-off” feature will temporarily disable the operator until the gate related issues mentioned above are properly addressed. Once the gate is functional, then the installer can reset the operator by pressing the UL RESET switch as shown.

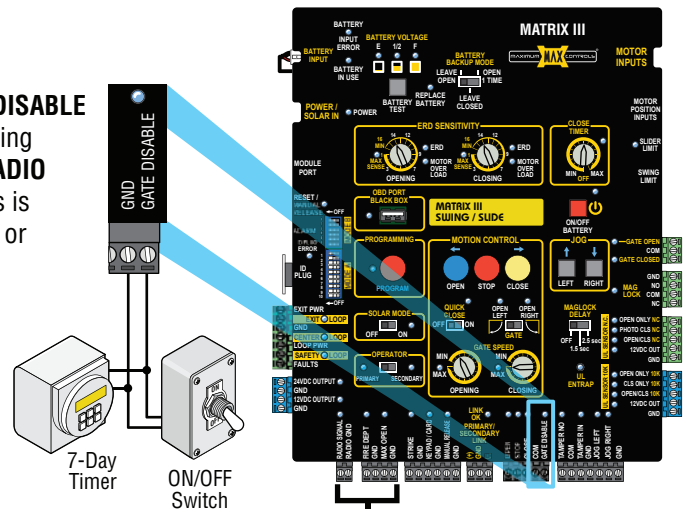

Enabled inputs when **GATE DISABLE** is turned ON.



Reset Operator out of shut off mode



Heavy gate or binding gate detected

TROUBLESHOOTING

This page and the next 3 pages can help troubleshoot problems that might occur after installation is complete.

USB BLACK BOX PORT

Download a simple .txt file to troubleshoot gate operator errors and view event history.

Event History Text Document Sample

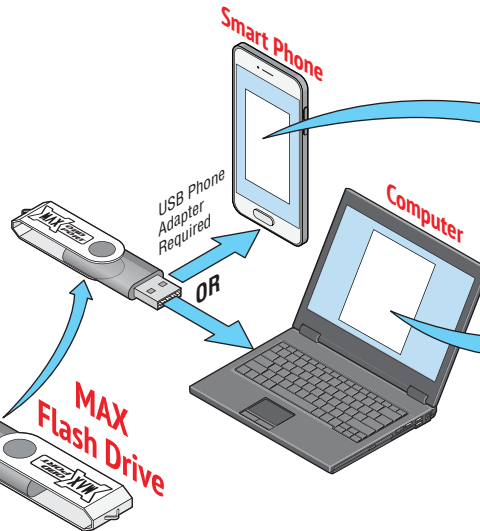
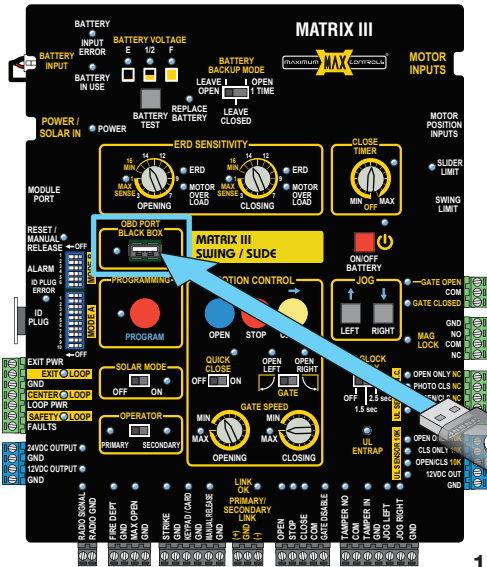

Event type clarification:
INFO: informational message only
WARNING: unusual event but doesn't cause system malfunction
ERROR: abnormal event, could cause system malfunction
ENTRAP: entrapment detection event

Event Report:	
Fri 07/11/2014 10:59:41	INFO : Cycle Counter
Fri 07/11/2014 10:59:41	ENTRAP : SEC_MC: First ERD Detected
Fri 07/11/2014 10:59:37	INFO : Radio Input Deactivated
Fri 07/11/2014 10:59:36	INFO : Radio Input Activated
Fri 07/11/2014 10:58:54	INFO : PRI_MC: Fully Open Position Learned
Fri 07/11/2014 10:58:53	INFO : SEC_MC: Fully Open Position Learned
Fri 07/11/2014 10:57:40	INFO : PRI_CIO: Communication Established
Fri 07/11/2014 10:57:38	ENTRAP : PRI_MC: Photo Cell Deactivated
Fri 07/11/2014 10:57:34	ENTRAP : PRI_MC: Photo Cell Activated
Fri 07/11/2014 10:57:21	INFO : Radio Input Deactivated
Fri 07/11/2014 10:57:21	INFO : Radio Input Activated
Fri 07/11/2014 10:56:46	WARNING: PRI_MC: Tamper Reported
Fri 07/11/2014 10:56:36	INFO : SEC_MC: Fully Open Position Unknown
Fri 07/11/2014 10:56:36	INFO : PRI_MC: Fully Open Position Unknown
Fri 07/11/2014 10:56:33	WARNING: PRI_MC: Tamper Reported
Fri 07/11/2014 10:56:33	ENTRAP : PRI_MC: Photo Cell Deactivated
Fri 07/11/2014 10:56:33	ENTRAP : PRI_MC: Photo Cell Activated
Fri 07/11/2014 10:56:33	ENTRAP : PRI_MC: Photo Cell Deactivated
Fri 07/11/2014 10:56:33	ENTRAP : PRI_MC: Photo Cell Activated

1. Plug MAX USB flash drive into **OBD port**. OBD LED will flash while file is downloading. Remove flash drive after LED stops flashing (up to 5 minutes to download).
2. Plug flash drive into any computer USB port **OR** smart phone using a USB phone adapter. The most recent **8000 events can be viewed**. No special software required.

TEST ENTRAPMENT SENSORS

Troubleshoot entrapment protection sensors:

1. Press and **HOLD** the **STOP** button & then the **OPEN** button together until beeping is heard, learn mode begins.

NOTE: DO NOT press the **OPEN** button before the **STOP** button or learn mode will **NOT** function.

2. LEDs should be **ON** if an entrapment sensor is detected in **EACH** input. If LEDs are **NOT** on, sensors have a problem.

Possible problems:

- Photocells are out of alignment
- Photocells are wired wrong - N.C. or N.O. depending on which photocells are used, see specific mfg instructions.
- Sensor is bad

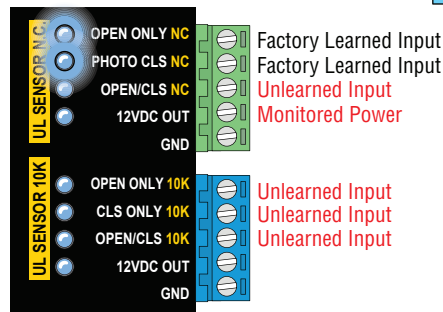

IMPORTANT: Sensing devices **MUST** be powered by Matrix III or they will **NOT** be **MONITORED**.

3. Press **STOP** button again within 5 min. to end learn mode, beeping stops.

NOTE: If **STOP** button is not pressed within 5 min. learn mode automatically end after 5 min.

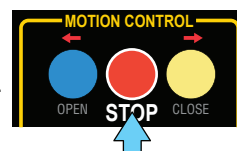

GATE CYCLING TROUBLESHOOTING

Use this table to help with troubleshooting AND operator LED troubleshooting on the next 2 pages.

Gate Symptom	Solutions (what to check)
Gate beeps but will not open or close for any command given.	<ul style="list-style-type: none"> • Check GATE SHUTOFF switch, it should be OFF. Turn switch ON then OFF again, possible chain drop event and switch needs to be recycled. GATE DISABLE LED should be OFF.
Gate moves slowly.	<ul style="list-style-type: none"> • Check if OPEN and CLOSE Limits have been learned. Refer to “Learn Gate Positions” (see 7). • Check if GATE SPEED rotary dial is set to MAX position (LED on). • Gate may be too heavy for operator (check for maximum gate weight for your model operator). • Check if "BATTERY IN USE" LED is ON. If so, gate is on Battery back up mode and battery is running low.
Gate beeps when opening and closing.	<ul style="list-style-type: none"> • Operator may be in battery back up mode. Check if “Mode 1” switches are set correctly. • Check if “Gate in Motion” Alarm feature is ON (“Mode 0” switches are set correctly).
Gate does NOT open.	<ul style="list-style-type: none"> • Check if Power LEDs are ON on both Matrix III and Toroid box. Check if “LINK ON” LED is ON. • Check if PRIMARY GATE "open RIGHT / open LEFT" switch is set properly. • Check if GATE SHUTOFF switch is OFF (GATE DISABLE LED should be OFF) • Check if GATE DISABLE LED is ON. If so, check if GATE DISABLE input is active. • Check if “PHOTO OPEN” LED or “OPEN/CLS” LED is ON or BLINKING. If so, check entrapment sensor wiring. • Check if “BATTERY IN USE” LED is ON. If so, battery may be too low and gate is kept closed (BATTERY BACK-UP MODE switch set to “Leave Closed”).
Gate does NOT close.	<ul style="list-style-type: none"> • Check if Power LEDs are ON on both Matrix III and Toroid box. Check if “LINK OK” LED is ON. • Check if “PHOTO CLS” LED is ON. If so, check entrapment sensor wiring and alignment. • Check if any loops are active, check SAFETY LOOP or EXIT LOOP LED is ON. • Check if any open command inputs are active (check if LED is ON on for: RADIO, FIRE DEPT, MAX OPEN, STRIKE, KEYPAD/RDR). Check device connected to the input that LED light is turned ON. • Check if PRIMARY GATE “open RIGHT / open LEFT” switch is set properly. • Check if GATE SHUTOFF switch is OFF (GATE DISABLE LED should be OFF) • Check if GATE DISABLE LED is ON. If so, check if GATE DISABLE input is active. • If “OPEN ONLY” LED or “OPEN/CLS” LED is ON or BLINKING. If so, check entrapment sensor wiring. • If “BATTERY IN USE” LED is ON and BATTERY BACK-UP MODE switch is set to “Leave Open”, then battery may be too low and gate is kept OPEN. • If “BATTERY IN USE” LED is ON and BATTERY BACK-UP MODE switch is set to “OPEN 1-TIME”, then if AC power is lost, gate will automatically open 1 time. • If “CLOSE TIMER” is OFF, then gate will not close automatically. A close command (i.e radio, close) is required to close gate. • Loop detector is defective (EXIT, or SAFETY). • Loop has a short or open. Measure loop resistance.
Gate stops prematurely and beeps, moves in opposite direction.	<ul style="list-style-type: none"> • If “ERD” LED is ON, an obstruction (ERD event) is detected. If no apparent obstruction, select a less sensitive ERD setting. • If “OPEN ONLY” LED is ON, entrapment sensor is triggered.
Gate will stop before reaching desired limit setting.	<ul style="list-style-type: none"> • Gate Open and Close Limits have not been learned properly. Relearn limit positions using jog Right and jog Left. • The magnet(s) are not installed in correct limit position on the chain. • Only for OPENING gate (not during closing cycle): Check if PARTIAL OPEN feature is turned ON. Relearn partial open position or turn off PARTIAL OPEN feature.
Gate stops abruptly while in motion.	<ul style="list-style-type: none"> • If “LINK OK” LED is OFF, then check wiring between Matrix III and Limit sensors. • Check if “OPEN/CLS” LED is ON. If so, check entrapment sensor wiring. • Motor hall sensor cable may be compromised. Unplug cable from Matrix III “Motor Inputs” and ensure wires are not broken and are crimped properly.
Gate re-opens while closing.	<ul style="list-style-type: none"> • Check if closing photocell is misaligned with reflector (check photocell connected to “PHOTO CLS” input or “OPEN/CLS” input). • Check if SAFETY LOOP is set too sensitive, then gate itself triggers SAFETY loop and reopens gate. Desensitize SAFETY LOOP detector.
Gate does not learn new magnet positions.	<ul style="list-style-type: none"> • Use jog Right and jog Left buttons to learn new positions instead of using open or close buttons.

MATRIX III LED TROUBLESHOOTING

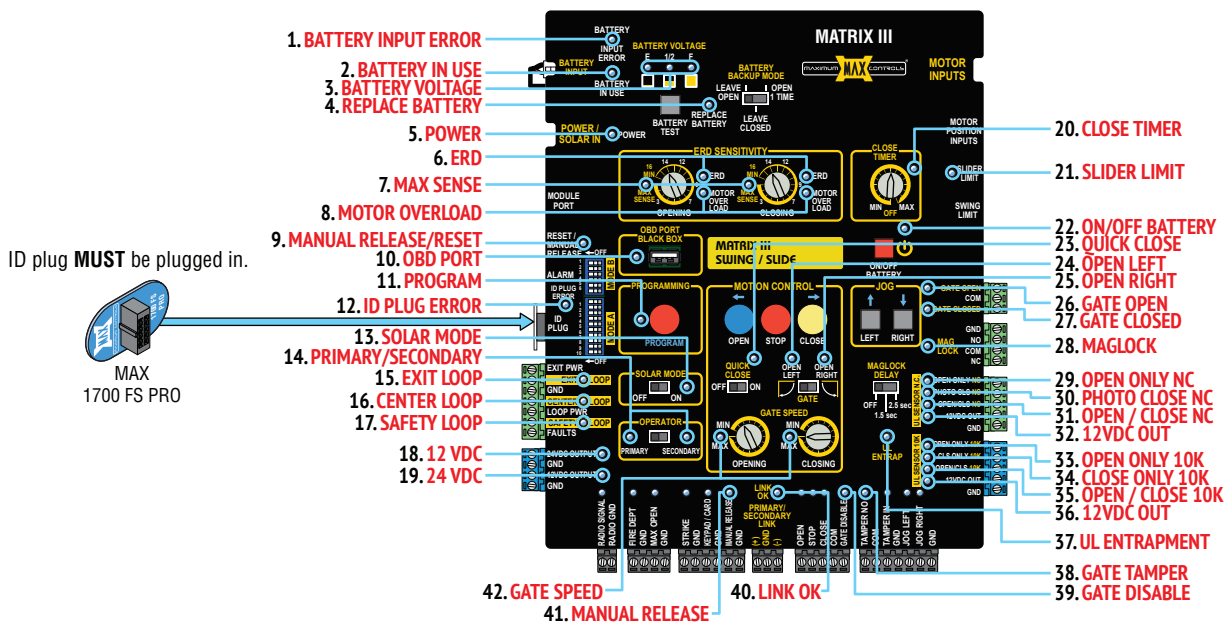

Matrix III LED Problem Condition	Normal LED	Solution(s) for Problem Condition
"BATTERY IN ERROR" LED is ON. "BATTERY IN USE" LED is ON	1 OFF 2	<ul style="list-style-type: none"> "BATTERY Plug" not plugged in to "BATTERY IN" port. AC power is lost, operator is in battery back-up mode. Check if Toroid box AC POWER ON/OFF SWITCH is ON. Measure power input DC voltage on Matrix 1 ("24V/GND" - 2-pin black connector), (expected reading 34 VDC if AC on, 25VDC if on Battery back-up).
"BATTERY VOLTAGE (E 1/2 F)" LEDs, only "E" is ON. "REPLACE BATTERY" LED is ON.	OFF 3 OFF 4	<ul style="list-style-type: none"> Battery is very LOW. Check if AC power ON/OFF switch is ON. If so, check AC power. Battery needs to be replaced if BATTERY TEST fails and "REPLACE BATTERY" LED is ON.
"BATTERY IN USE" and "POWER" LED are FLASHING PRIMARY Matrix III "LINK OK" LED is OFF	OFF / ON 2 / 5 ON 40	<ul style="list-style-type: none"> Battery not plugged in to BATTERY INPUT port. Check if limit sensors are plugged into PRIMARY MATRIX III "SLIDER LIMIT" input.
SECONDARY Matrix III "LINK OK" LED is OFF	ON 40	<ul style="list-style-type: none"> Check wiring between PRIMARY RS485 (+, -, gnd) and SECONDARY RS485 (+, -, gnd) terminals, connect [(+) to (+)], [(-) to (-)] and [GND to GND]. Check if limit sensors are plugged into SECONDARY Matrix III "SLIDER LIMIT" input.
"UL Entrap" LED is ON "ERD" LED is FLASHING	ON 37 ON 6	<ul style="list-style-type: none"> An entrapment event has occurred, check if an entrapment sensor was triggered (see if PHOTO CLS, OPEN ONLY, or OPEN/CLS LEDs are on). An ERD event may have occurred. Check for gate obstruction. ERD sensitivity is too high for application. Re-adjust ERD setting, (see 8).
"PHOTO CLS" LED is ON "CLS ONLY 10K" LED is ON	OFF 30 / 34	<ul style="list-style-type: none"> Sensor on PHOTO CLS or CLS ONLY 10K inputs (photocell or edge) may have detected an obstruction while closing gate. Photocell on PHOTO CLS or CLS ONLY 10K inputs is misaligned with reflector.
"PHOTO CLS" LED is flashing "CLS ONLY 10K" LED is flashing	OFF 30 / 34	<ul style="list-style-type: none"> Sensor on PHOTO CLS or CLS ONLY 10k inputs (photocell or edge) may not be wired properly, (see 5). Sensor is NOT a N.C. monitored sensor that is UL325 2018 compliant. Sensor might need to be re-learned. Sensor is damaged or malfunctioning.
"OPEN ONLY" LED is ON "OPEN ONLY" LED is FLASHING	OFF 29 / 33 OFF 29 / 33	<ul style="list-style-type: none"> Sensor on OPEN ONLY input (photocell or edge) may have detected an obstruction while cycling gate. Photocell on OPEN ONLY input is misaligned with reflector. Sensor on OPEN ONLY input (photocell or edge) may not be wired properly, (see 5). Sensor is NOT a N.C. monitored sensor that is UL325 2018 compliant. Sensor on OPEN ONLY is damaged or malfunctioning. Sensor might need to be re-learned.
"MAX SENSE" LED is ON	OFF 7	<ul style="list-style-type: none"> MOST sensitive setting for ERD entrapment detection. Select a less sensitive setting (recommend level 10 thru 16)
"MANUAL RELEASE/RESET" LED is ON but manual release is not working "OBD PORT" LED is FLASHING	OFF 9 / 41 OFF 10	<ul style="list-style-type: none"> Connected external device to MANUAL RELEASE input is not working, check wiring. replace device. Up to 8000 event history and error codes are being downloaded to connected flash drive. Up to 5 min.
"PROGRAM" LED is FLASHING	OFF 11	<ul style="list-style-type: none"> Program button has been pressed and programming mode is active. Press button again to leave programming mode.

Table continued on next page

MATRIX III LED CONTINUED

Matrix III LED Problem Condition	Normal LED	Solution(s) for Problem Condition
"ID PLUG" LED is FLASHING and board beeping	OFF 12	<ul style="list-style-type: none"> • Insert ID PLUG module that is tethered to chassis into "ID PLUG" connector.
"SOLAR MODE" LED is ON	OFF 13	<ul style="list-style-type: none"> • Operator is being powered by solar panel ONLY.
"OPEN/CLS" LED is ON	OFF 31	<ul style="list-style-type: none"> • Sensor on OPEN/CLS input (photocell or edge) may have detected an obstruction while opening or closing gate.
"OPEN/CLS" LED is FLASHING		<ul style="list-style-type: none"> • Photocell on OPEN/CLS input is misaligned with reflector. • Sensor on OPEN/CLS input (photocell or edge) may not be wired properly, (see 5). • Sensor is NOT a N.C. monitored sensor that is UL325 2018 compliant. • Sensor on OPEN/CLS is damaged or malfunctioning. • Sensor might need to be re-learned.
"MOTOR OVERLOAD" LED is ON	OFF 8	<ul style="list-style-type: none"> • Check if gate is binding against catch post or bracket in opened or closed position. • Check if gate moves manually with low resistance throughout its full range of motion. • Check if chain is installed inline with idle wheels in both OPEN and CLOSED positions.
"EXIT" LOOP LED is FLASHING or constantly ON	OFF 15	<ul style="list-style-type: none"> • Loop fault condition: Check if EXIT loop wires are connected into to loop input connector properly. • Check if loop detector is inserted properly in Loop Rack slot. • Set unique loop detector frequency for each loop detector used. • Loop Detector might be defective. Replace defective loop detector. <p>NOTE: RENO loop detector LED's flash as default, but function normally (ignore the flashing).</p>
"SAFETY" LOOP LED is FLASHING or constantly ON	OFF 17	<ul style="list-style-type: none"> • Loop fault condition: check if SAFETY loop wires are connected into to loop input connector properly. • Check if SAFETY loops are wired in series. • Check if loop detector is inserted properly in Loop Rack slot. • Set unique loop detector frequency for each loop detector used. • Loop Detector might be defective. Replace defective loop detector. <p>NOTE: RENO loop detector LED's flash as default, but function normally (ignore the flashing).</p>
"GATE DISABLE" LED is ON	OFF 35	<ul style="list-style-type: none"> • Check if "Manual Disconnect" switch is ON, Turn it OFF. If it is OFF, cycle the switch (ON then OFF). • Check if the chain is dropped. If so, gate is disabled for safety. Re-install chain and cycle the "Manual Disconnect" switch (ON then OFF) to enable operator. • Check if an external device is triggering GATE DISABLE input. Disconnect devices individually to determine possible false triggering of GATE DISABLE.
"MAG LOCK" LED is FLASHING	OFF 28	<ul style="list-style-type: none"> • Maglock power is lost. Check if maglock power transformer is wired properly or needs to be replaced. • Switch is set to delay but no maglock is connected. Set switch to OFF
"GATE TAMPER" LED is FLASHING	OFF 34	<ul style="list-style-type: none"> • Gate was manually moved off of its CLOSED position causing Tamper Relay to trigger for few seconds.
"12VDC" LED is OFF. "24VDC" LED is OFF	ON 18 or 19	<ul style="list-style-type: none"> • Check for a short in wiring to connected device. DO NOT power external keypads or telephone entry to this port (only use for radio receiver / photocell).
"SLIDER LIMIT" LED is ON	OFF 21	<ul style="list-style-type: none"> • Only ON if factory installed plug is plugged in. Re-install plug into SWING LIMIT connection for swing gate operator.
"ON/OFF BATTERY" LED is OFF	ON 22	<ul style="list-style-type: none"> • Batteries are turned OFF. Turn toroid box AC POWER switch ON and batteries automatically turn ON.
"QUICK CLOSE" LED is ON	OFF 23	<ul style="list-style-type: none"> • Quick Close feature is turned ON. If this feature is not desired, turn quick close OFF.
"GATE SPEED" LEDs are ON but gate moves slowly.	ON 42	<ul style="list-style-type: none"> • Check if OPEN and CLOSE Limits have been learned. Refer to "Learn Gate Positions" (see 7). • ONLY Maximum settings will turn LEDs ON. All other settings, LEDs remain OFF.

POST 2018 WITH Built-in Resistor NORMALLY CLOSED (NC) Wiring to E3K Photocell

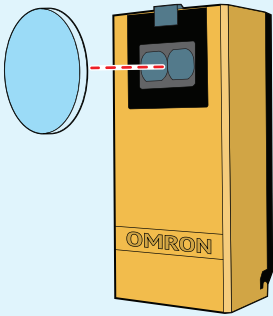

**OPENING Direction
Photocell (Reflector)**



NOTE: To meet the UL 325 2018 standard,
Type B1 Non-Contact sensor entrapment
protection device MUST be MONITORED
by the gate operator.

Installation Steps:

1. Set switch to "LIGHT ON"
2. Wire 12V power to photocell
3. Wire **OPEN ONLY NC** to photocell **N02**
Wire **GND** to photocell **C2**
4. Align photocell to reflector
5. Adjust sensitivity

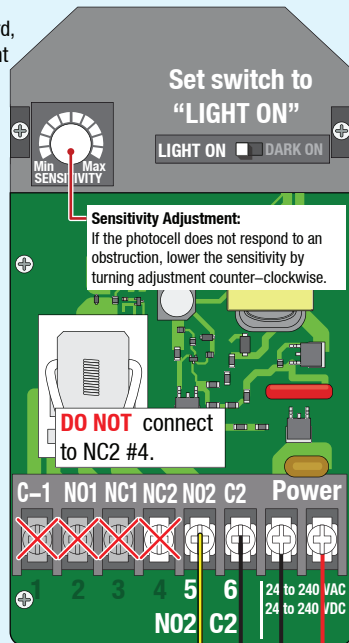

Sensitivity Adjustment:
If the photocell does not respond to an
obstruction, lower the sensitivity by
turning adjustment counter-clockwise.

DO NOT connect
to NC2 #4.

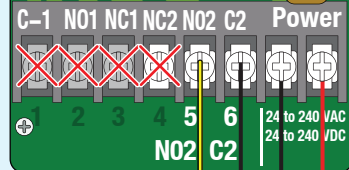

OK to
use
12VDC

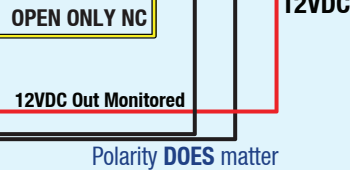
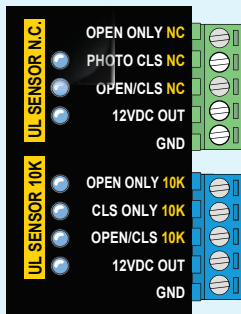

Polarity **DOES** matter

IMPORTANT:
Photocell **MUST** be powered
by **12VDC OUT Monitored** or
it will **NOT** be **MONITORED**.

For 10K Resistor E3K Photocell wiring see next page

POST 2018 WITH Built-in Resistor NORMALLY CLOSED (NC) Wiring to E3K Photocell

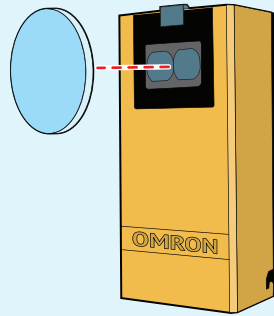

**CLOSING Direction
Photocell (Reflector)**



NOTE: To meet the UL 325 2018 standard,
Type B1 Non-Contact sensor entrapment
protection device MUST be MONITORED
by the gate operator.

Installation Steps:

1. Set switch to "LIGHT ON"
2. Wire 12V power to photocell
3. Wire **PHOTO CLS NC** to photocell **N02**
Wire **GND** to photocell **C2**
4. Align photocell to reflector
5. Adjust sensitivity

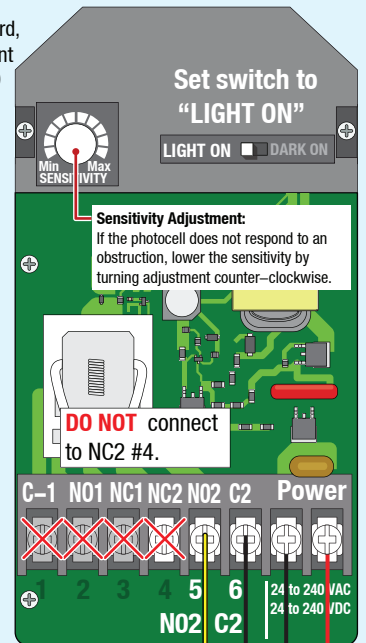

Sensitivity Adjustment:
If the photocell does not respond to an
obstruction, lower the sensitivity by
turning adjustment counter-clockwise.

DO NOT connect
to NC2 #4.

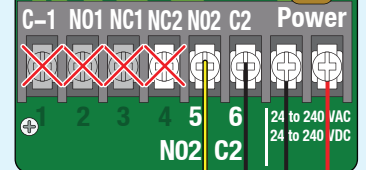

OK to
use
12VDC

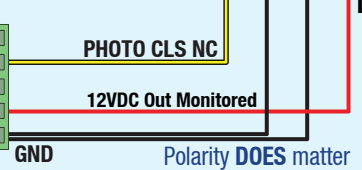
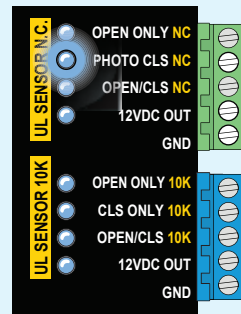

Polarity **DOES** matter

IMPORTANT:
Photocell **MUST** be powered
by **12VDC OUT Monitored** or
it will **NOT** be **MONITORED**.

For 10K Resistor E3K Photocell wiring see next page

PRE 2018 WITHOUT Built-in Resistor NORMALLY CLOSED (NC) Wiring to E3K Photocell

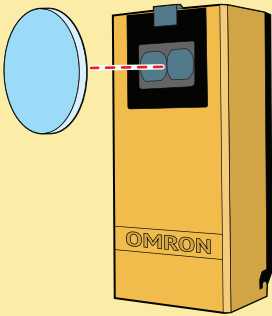

OPENING Direction Photocell (Reflector)

NOTE: To meet the UL 325 2016 standard, Type B1 Non-Contact sensor entrapment protection device MUST be MONITORED by the gate operator.

Installation Steps:

1. Set switch to "LIGHT ON"
2. Wire 12V power to photocell
3. Wire **OPEN ONLY NC** to photocell **NO1**
Wire **GND** to photocell **C-1**
4. Align photocell to reflector
5. Adjust sensitivity

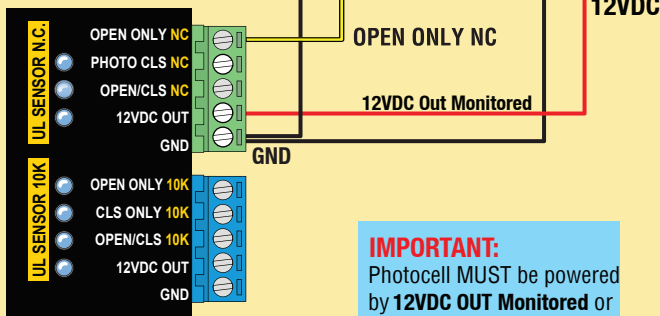
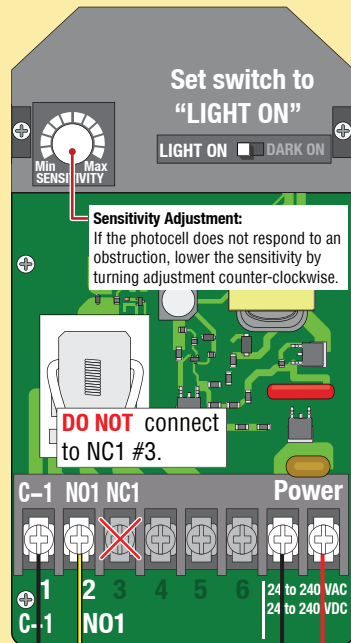

IMPORTANT:
Photocell MUST be powered by 12VDC OUT Monitored or it will NOT be MONITORED.

NOTE: DO NOT use 10K Resistor included with photocell.

PRE 2018 WITHOUT Built-in Resistor NORMALLY CLOSED (NC) Wiring to E3K Photocell

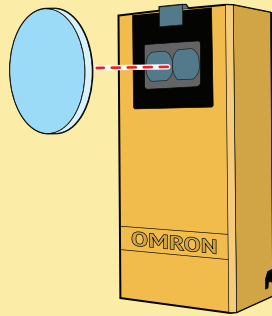

CLOSING Direction Photocell (Reflector)

NOTE: To meet the UL 325 2016 standard, Type B1 Non-Contact sensor entrapment protection device MUST be MONITORED by the gate operator.

Installation Steps:

1. Set switch to "LIGHT ON"
2. Wire 12V power to photocell
3. Wire **PHOTO CLS NC** to photocell **NO1**
Wire **GND** to photocell **C-1**
4. Align photocell to reflector
5. Adjust sensitivity

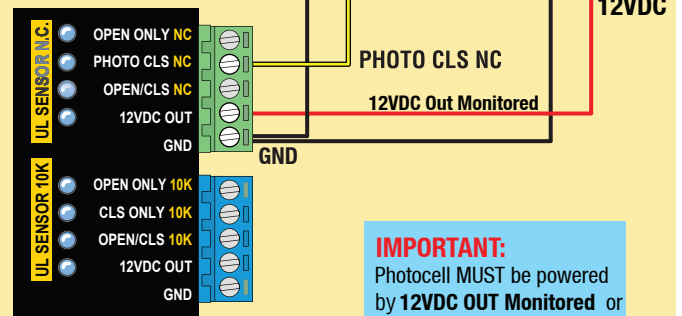
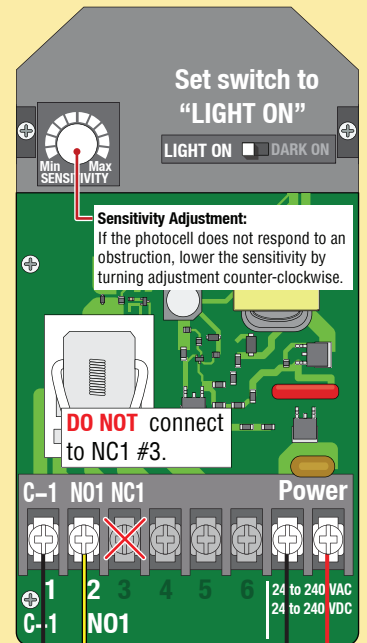

IMPORTANT:
Photocell MUST be powered by 12VDC OUT Monitored or it will NOT be MONITORED.

NOTE: DO NOT use 10K Resistor included with photocell.

UL325-2018

10K Resistor wiring to E3K Photocell
(Use ONLY For OPENING Direction on 10K Port)

Installation Steps:

1. Set switch to "LIGHT ON"
2. Wire 12V power to photocell
3. Wire **OPEN ONLY 10K** to photocell **NC1**
Wire **GND** to photocell **C-1**
4. Align photocell to reflector
5. Adjust sensitivity

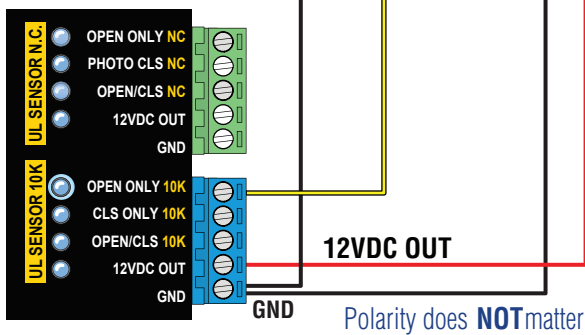
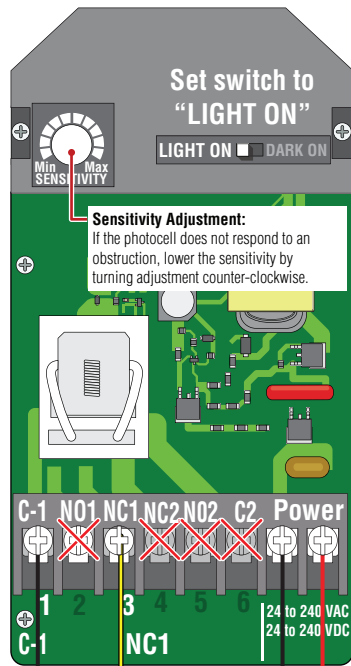

OPENING Direction Photocell (Reflector)

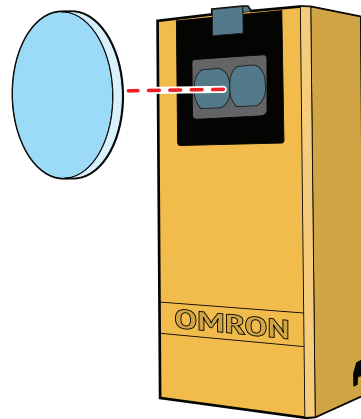

UL 2018 Label on packaging

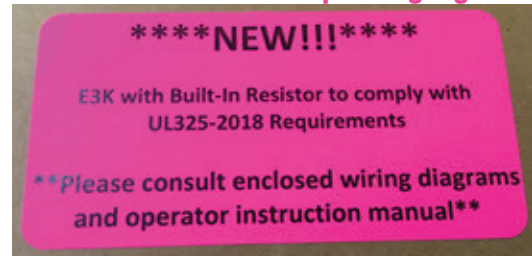

NOTE: To meet the UL 325 2018 standard, Type B1 Non-Contact sensor entrapment protection device **MUST** be MONITORED by the gate operator.

EMX WEL-200 Wiring Guide FOR MAX PRO SERIES

RECEIVER WEL-200R

OPENING TRANSMITTER

WEL-200T



CLOSING TRANSMITTER

WEL-200T

1 WIRE WEL-200R
OPEN & CLOSE RELAYS
TO MATRIX III
10K SENSOR INPUTS

EMX WEL-200R

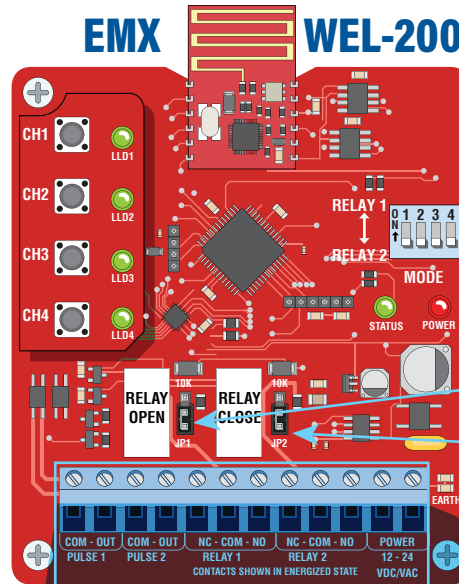

2 INSERT BOTH JUMPERS
IN 10K POSITION

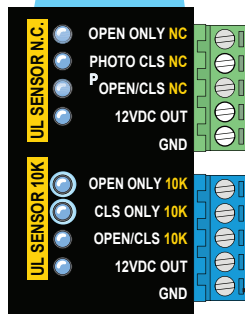
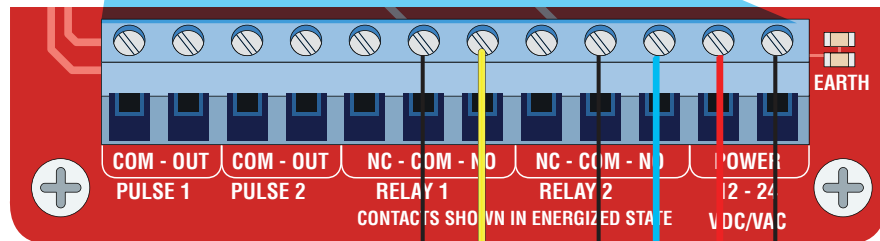
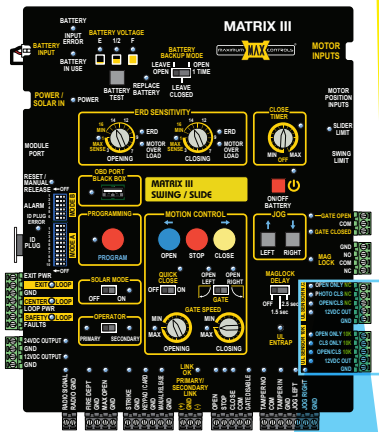
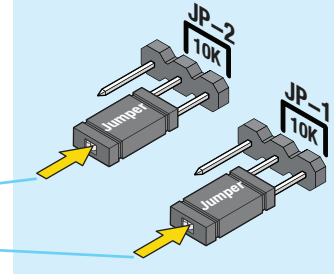

WIRE TO 'NO' OF RELAY OPEN

WIRE TO 'NO' OF RELAY CLOSE

Polarity does **NOT** matter for power

GND

Connecting is a two step process. First, on the receiver, press and hold the channel assignment switch until the green status LED begins rapidly flashing, then release; this will clear any existing assignment for that particular channel. Hold down the connection switch on the transmitter. If it is not currently connected to a receiver, it will begin flashing rapidly until successfully connecting. Detailed instructions are given below.

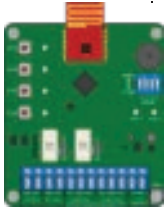

NOTE: If there are no existing connections, the *receiver's* status LED will blink rapidly while it is finding a clean operating frequency (this can last a few seconds)
After initialization, the system status LED will flash on/off once every 2 seconds

STEPS

1



Set each channel to the desired OPEN/CLOSE direction function using the MODE dip switch. **If a DIP switch is in the OPEN position, then that channel will trigger the OPEN Relay on receiver. Otherwise, it will trigger the CLOSE Relay.**

2



Install 2 AA Lithium batteries in the **WEL-200T (transmitter)**

The green LED on the transmitter will quickly flash 2x every two seconds

3



Install a properly terminated edge to the **transmitter** (8.2k or 10k termination)

4

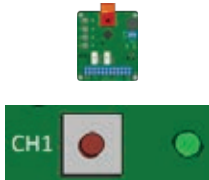

On the **receiver**, hold down the desired channel assignment switch until all four channel LEDs activate and the system status LED begins flashing rapidly, then release the switch.

5

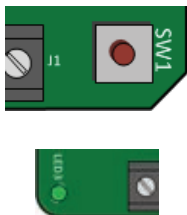

On the **transmitter**, hold down the connection switch (next to the terminal block)

The LED on the **transmitter** will begin flashing rapidly after ~4 seconds

Upon successful connection, the LED will flash once every two seconds. If the **transmitter** fails to connect, it will return to its initial state, with the LED flashing twice every two seconds. If this occurs, repeat steps above.

TESTING

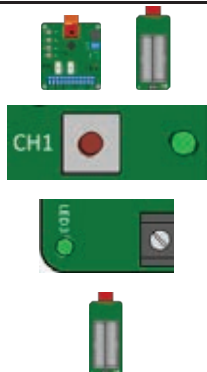

Without activating the edge, observe the channel status LED, it should be OFF.

When the edge is activated, the **receiver** channel status LED will turn on and the corresponding OPEN/CLOSE direction output will activate. The **transmitter** status LED will blink once every *second* when the edge is activated. If the channel does not exhibit this behavior, double check the edge wiring/termination and transmitter batteries.

FACTORY RESET

Power down receiver. Hold channels 1 and 4 down simultaneously while powering receiver back up.

EMX IRB-RET2 WIRING

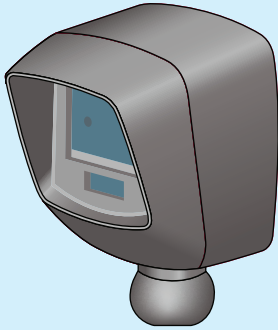

IMPORTANT: Photocell MUST be powered by 12VDC OUT or it will NOT be MONITORED.

NOTE: To meet the UL 325 2018 standard, Type B1 Non-Contact sensor entrapment protection device MUST be MONITORED by the gate operator.

Photocell (Reflector) CLOSING Direction

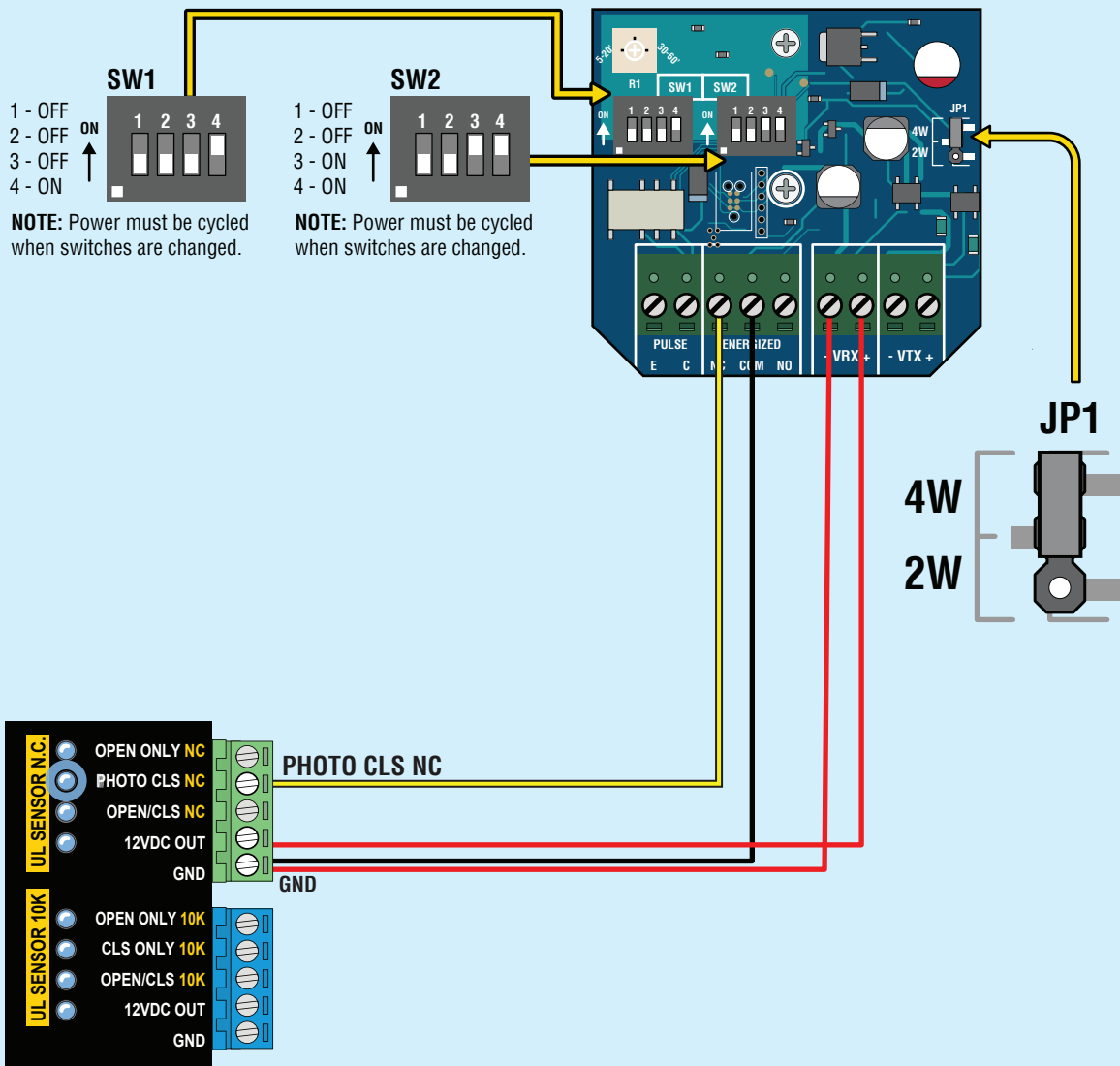

EMX IRB-RET WIRING

IMPORTANT: Photocell **MUST** be powered by **12VDC OUT** or it will **NOT** be **MONITORED**.

Installation Steps:

1. Set DIP-switches
2. Remove jumper JP-5
3. Insert jumper on 4W JP-6
4. Wire 12V power to photocell (VRX)
5. Wire DSP board **PHOTO CLS NC** to photocell **NC (Energized)**
Wire DSP board **GND** to photocell **COM (Energized)**
6. Align photocell to reflector
7. Adjust sensitivity

NOTE: To meet the UL 325 2018 standard, Type B1 Non-Contact sensor entrapment protection device **MUST** be **MONITORED** by the gate operator.

Photocell (Reflector) CLOSING Direction

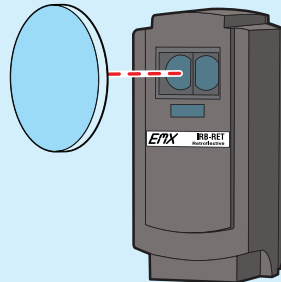

Sensitivity Adjustment:
If the photocell does not respond to an obstruction, lower the sensitivity by turning adjustment counter-clockwise.

DIP-Switches

- | | | | | | |
|---------|---|---|---|---|---|
| 1 - OFF | 0 | 1 | 2 | 3 | 4 |
| 2 - OFF | N | | | | |
| 3 - OFF | ↑ | | | | |
| 4 - ON | | | | | |

NOTE: Power must be cycled when switches are changed.

For RED BOARD

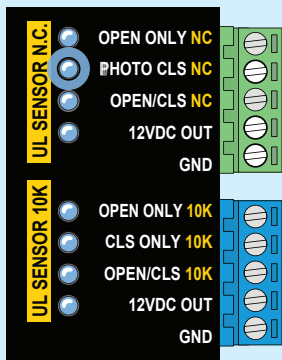
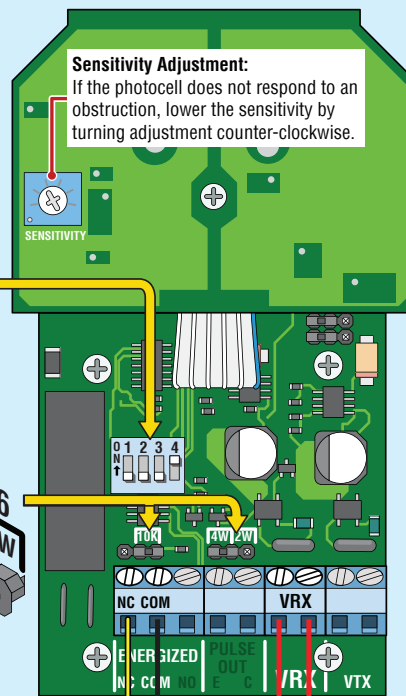
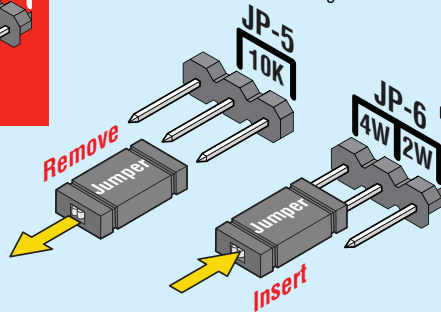
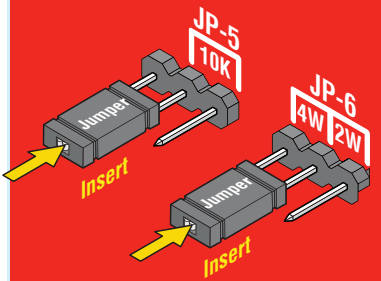

PHOTO CLS NC

GND

12VDC OUT
Polarity does NOT matter

Blue Transmitter (TX) / Red Receiver (RX) Boards

EMX IRB-MON

Photocell (Thru-Beam) CLOSING Direction Single Gate Operator

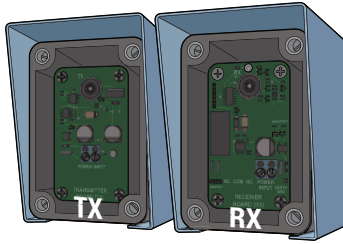
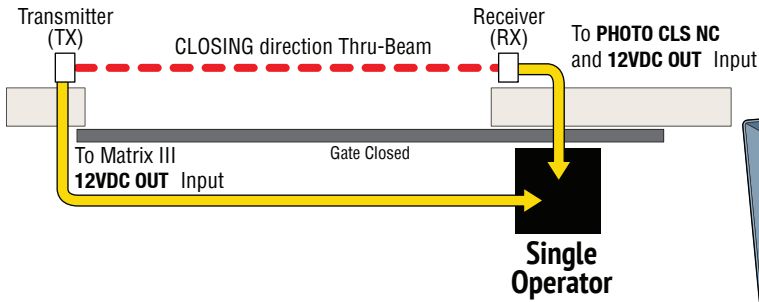

IMPORTANT: Photocells **MUST** be in alignment or fault will occur. Green LED will remain **ON** receiver when in proper alignment.

BLUE BOARD Transmitter (TX)

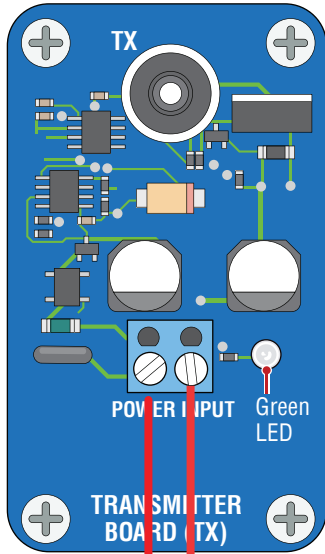

Installation Steps:

1. Set DIP-switches on receiver.
2. Install jumper on receiver.
3. Wire Matrix III 12VDC OUT power to receiver.
4. Wire PHOTO CLS NC to receiver photocell NC. Wire Matrix III GND to receiver photocell COM.
5. Wire 12V Matrix III power to transmitter.
6. Align photocells.
7. Adjust sensitivity on receiver.

Sensitivity Adjustment:

If the photocell does not respond to an obstruction, lower the sensitivity by turning adjustment counter-clockwise.

DIP-switches:

1, 2, 4 are OFF. Switch 3 is ON

RED BOARD Receiver (RX)

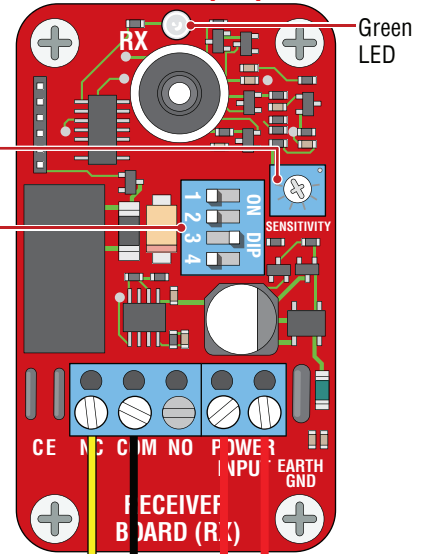

IMPORTANT: Photocells **MUST** be powered by Matrix III or they will **NOT** be **MONITORED**.

12VDC OUT
Polarity does **NOT** matter

GREEN BOARD Receiver (RX)

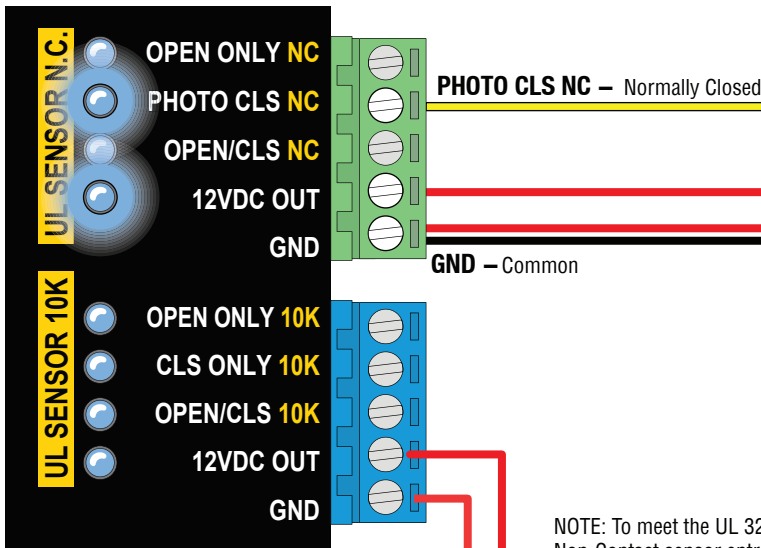
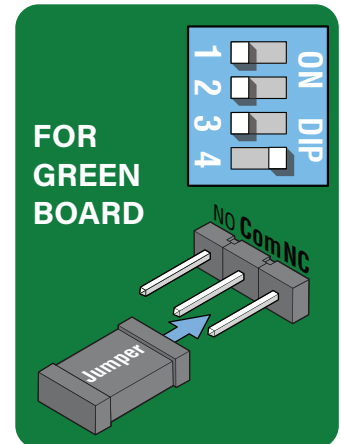

NOTE: To meet the UL 325 2018 standard, Type B1 Non-Contact sensor entrapment protection device **MUST** be **MONITORED** by the gate operator.

Green Transmitter (TX) / Green Receiver (RX) Boards

EMX IRB-MON

Photocell (Thru-Beam) CLOSING Direction Dual Gate Operators

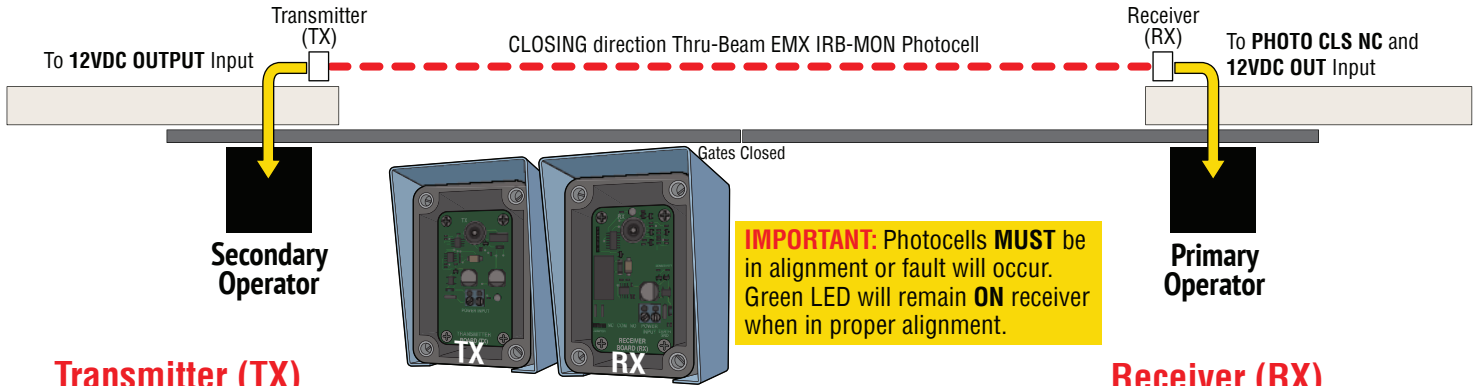

Transmitter (TX)

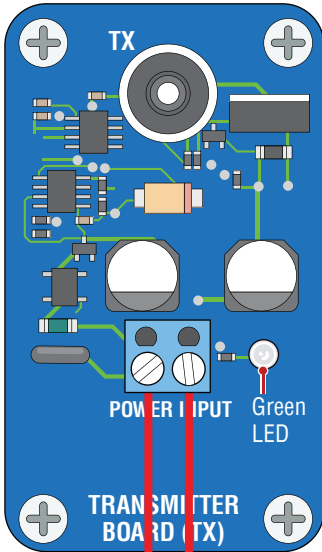

Installation Steps:

1. Set DIP-switches on receiver.
2. Install jumper on receiver.
3. Wire **12V** Primary Matrix III power to **receiver**.
4. Wire Primary Matrix III **PHOTO CLS NC** to receiver photocell **NC**. Wire Primary Matrix III **GND** to receiver photocell **COM**.
5. Wire **12V** Secondary Matrix III power to **transmitter** as shown.
6. Align photocells.
7. Adjust sensitivity on receiver.

Receiver (RX)

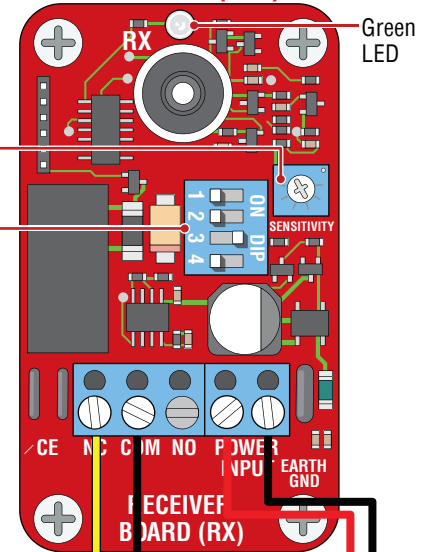

Sensitivity Adjustment:
If the IRB-MON does not respond to an obstruction, lower the sensitivity by turning adjustment counter-clockwise.

DIP-switches:
1, 2, 4 are OFF.
Switch 3 is ON

12VDC OUTPUT
Polarity does NOT matter

Secondary Matrix III

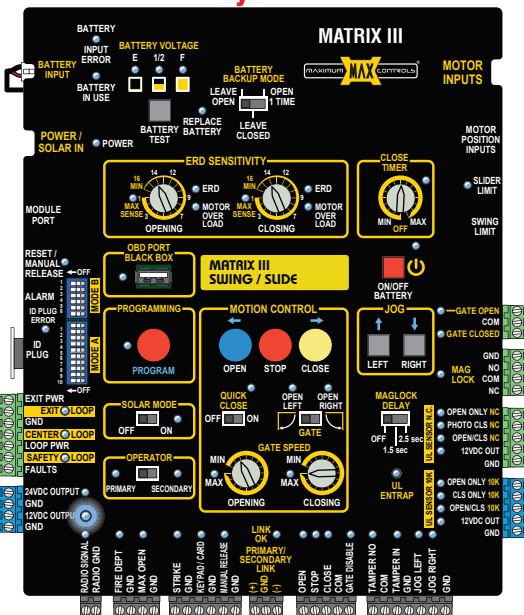

Primary Matrix III

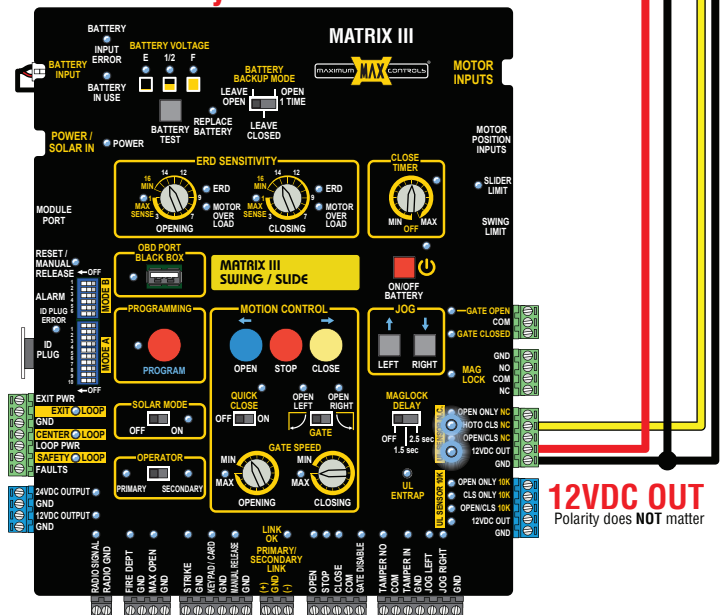

NOTE: To meet the UL 325 2018 standard, Type B1 Non-Contact sensor entrapment protection device MUST be MONITORED by the gate operator.

IMPORTANT: Photocell MUST be powered by PRIMARY Matrix III or they will NOT be MONITORED.

MILLER RBAND MONITORED WIRELESS

Channel 1 & 2 transmitters **MUST** be programmed by RBAND receiver. See below or Miller Edge Wireless RBAND instruction sheet to program transmitters to receiver.

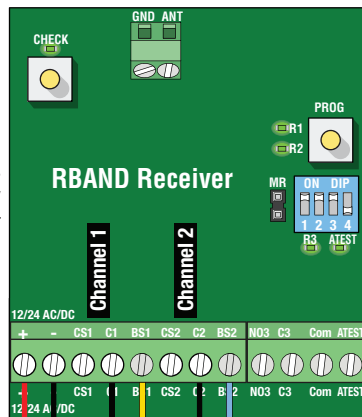

DIP-Switches
 1-ON
 2-ON
 3-ON
 4-OFF

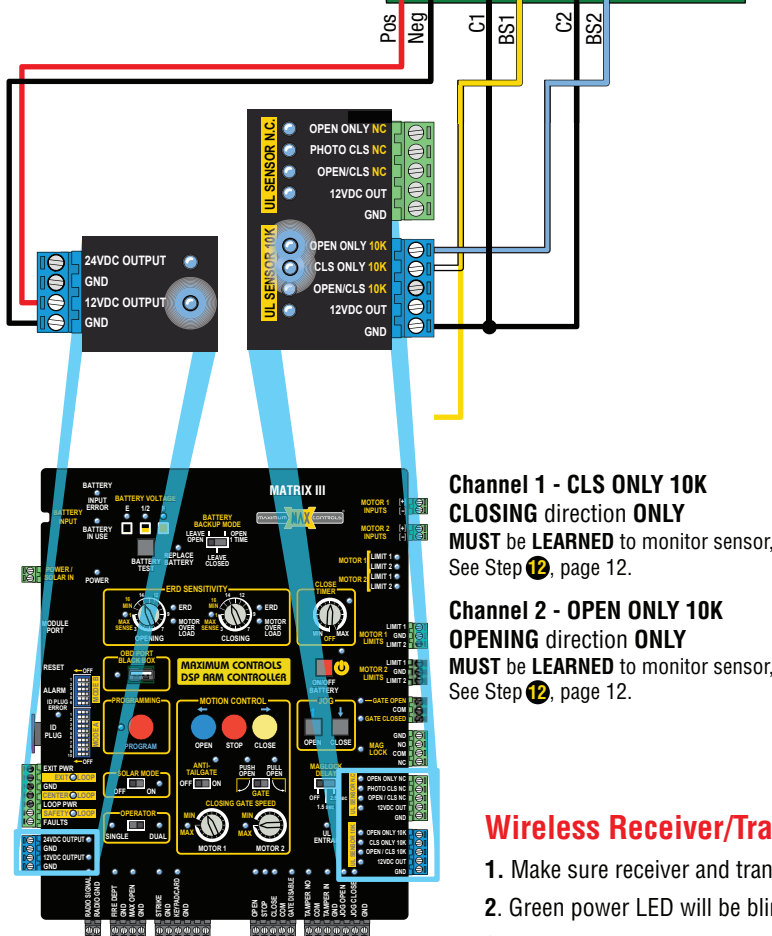
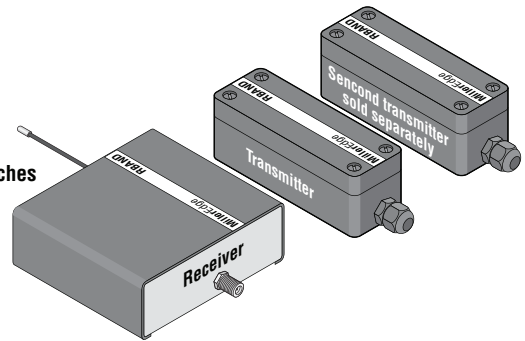

Channel 1 - CLS ONLY 10K
 CLOSING direction ONLY
 MUST be LEARNED to monitor sensor,
 See Step 12, page 12.

Channel 2 - OPEN ONLY 10K
 OPENING direction ONLY
 MUST be LEARNED to monitor sensor,
 See Step 12, page 12.

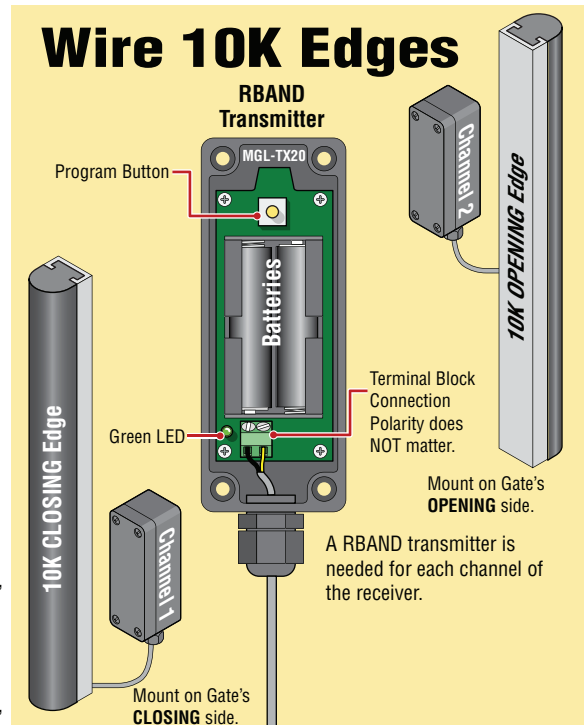

Terminal Block Connection
 Polarity does NOT matter.

Mount on Gate's
OPENING side.

Mount on Gate's
CLOSING side.

A RBAND transmitter is needed for each channel of the receiver.

Wireless Receiver/Transmitter Programming:

1. Make sure receiver and transmitters have power.
2. Green power LED will be blinking on channel 1 transmitter (unlearned).
3. To enter learn mode, press and hold the receiver program button for ~2 seconds until the R1 LED turns on, then release the button.
4. Press the transmitter program button for ~2 seconds. The receiver will beep. Wait 10 seconds for an additional beep to complete programming.
5. To program a transmitter to channel 2, press and hold the receiver program button until the second beep, then release the button. The R2 LED should be on. Repeat step 4 for channel 2 transmitter.

ERASE PROGRAMMING. If you need to replace a transmitter or you have any other programming issues, you may need to erase the receiver.

1. To erase transmitters programmed into the receiver, use a screwdriver to short the two pins marked MR next to the DIP-switches.
2. While shorting the pins, press and hold the program button for several seconds; you will hear a series of 10 beeps followed by a rapid chirping sound.
3. When the chirping stops, release the program button. Wait ~10 seconds and you will hear 2 beeps. The receiver is now ready to be reprogrammed.

Transmitter Solutions iGaze RE Wireless Edge Transceiver Wiring Diagram



**TRANSMITTER
TCOO900**



**RECEIVER
RCOO900**

QUICK START GUIDE

BELOW IS THE MOST COMMON INSTALLATION

**DIP SWITCH LEGEND:
DIP SWITCH= RED**

RCOO900 - 10kΩ output on both
(receiver) relay 1 and relay 2.

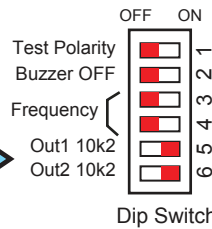

ROO900

Output relay
0.5A a 42.4Vac
1A a 30Vdc

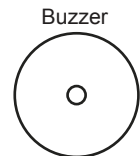

Programming/
Reset Key



**DIPSWITCHES
5 & 6
MUST BE
ON FOR
10K PORT**

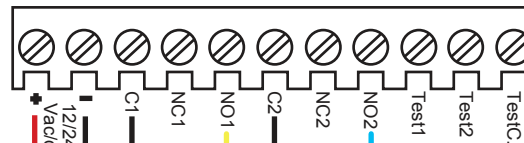
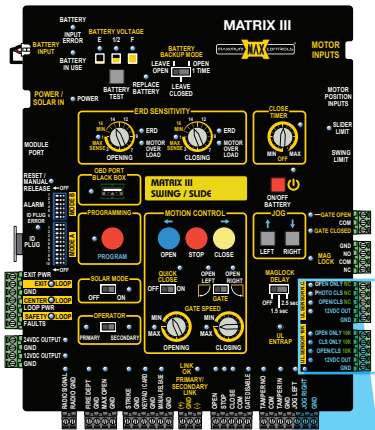

**WIRE TO 'NO' OF RELAY OPEN
WIRE TO 'NO' OF RELAY CLOSE**

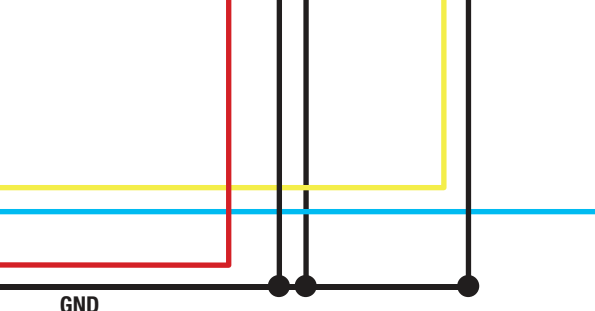
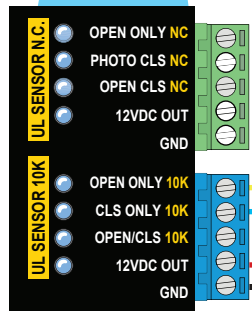

BELOW IS THE MOST COMMON INSTALLATION



TCOO900 - Both safety edges are 8.2kΩ (transmitter) or 10kΩ resistive

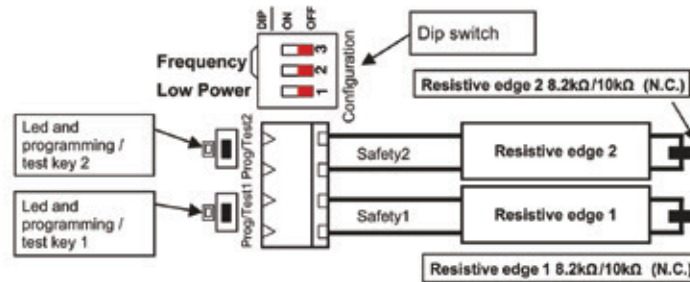

MOUNT THE TCOO900 AS HIGH AS POSSIBLE AND IN SUCH WAY AS THERE ARE NO OBSTACLES IN THE DIRECTION OF THE RCOO900 AND IN SUCH A WAY AS THE MAXIMUM DISTANCE BETWEEN THE TWO DEVICES IS LESS THAN 60 FEET (MAX 20 METERS / 60 FEET).

WARNING: install the TCOO900 at a minimum height of 8" from the ground. Keep the installation area clean of debris which can effect the normal operation of the system.

NOTE: Transmitter Solutions is not responsible for any damage caused by an improper, incorrect, or unintended use of the product.

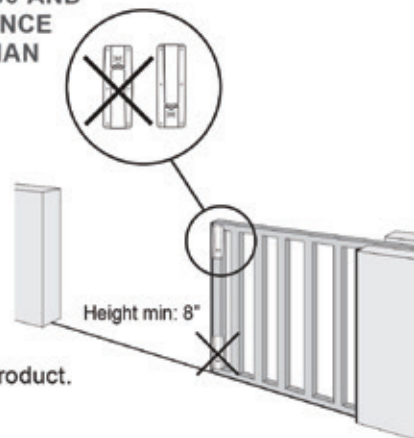

For pairing Transmitter and Receiver, please refer to the Transmitter Solutions manual.

WIRING OVERVIEW

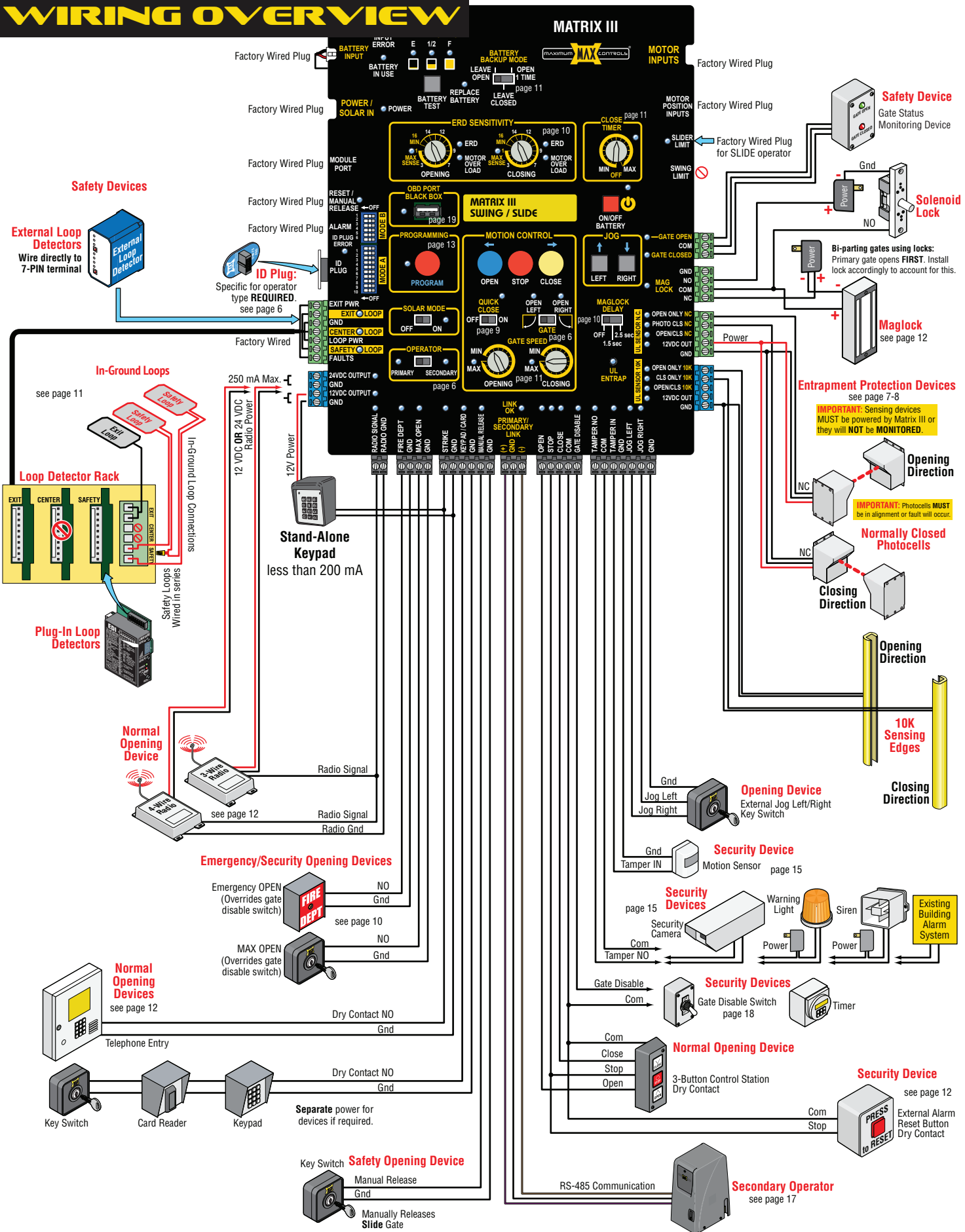

OPTIONAL MAGNET LIMIT SENSORS

Magnet limit sensors are sold separately.

The **GRAY** limit sensor **MUST** be mounted on the **OPEN POSITION** on the Back Plate on operator. The limit sensor magnets **MUST** be installed on **BOTH** ends of chain to indicate the **OPEN** and **CLOSE** positions of the gate. They will activate the corresponding **LIMIT SENSOR** (Gray-Open or Black-Close) when they move within range, stopping the gate at the desired positions.

IMPORTANT: LEDs **MUST** light up when gate reaches **OPEN** and **CLOSE** positions or operator **WILL NOT** learn gate positions. If gate positions are not learned, gate cycling speed will **remain** slow during normal operation.

IMPORTANT: Limit Sensor Magnets **MUST** be installed on **BOTTOM** of chain as shown.

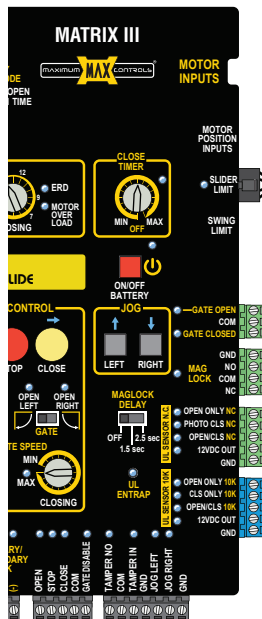

Limit Sensor Matrix III Connection

IMPORTANT: Gray Limit sensor **MUST** be in the **OPEN** position on the operator.

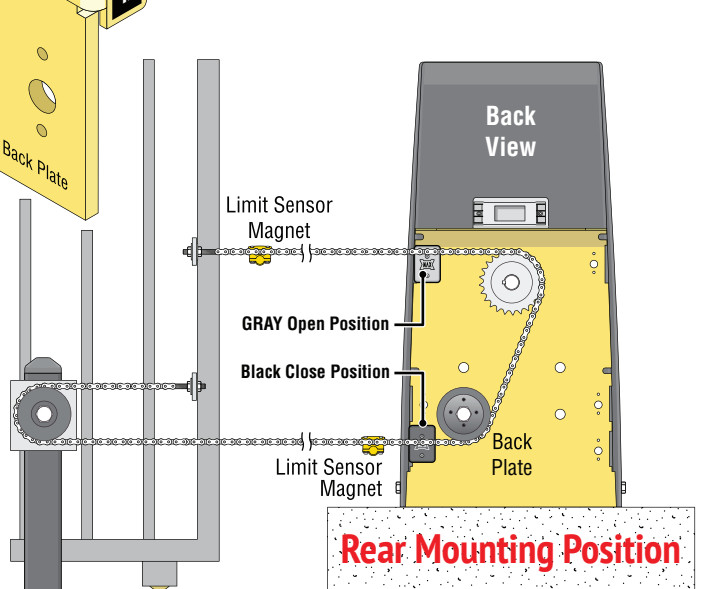
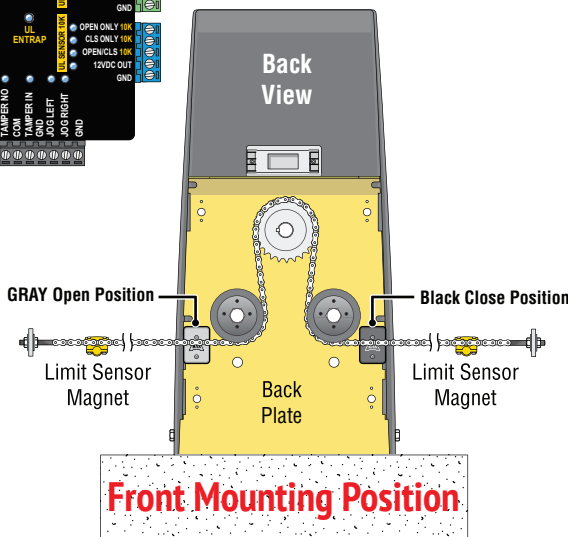
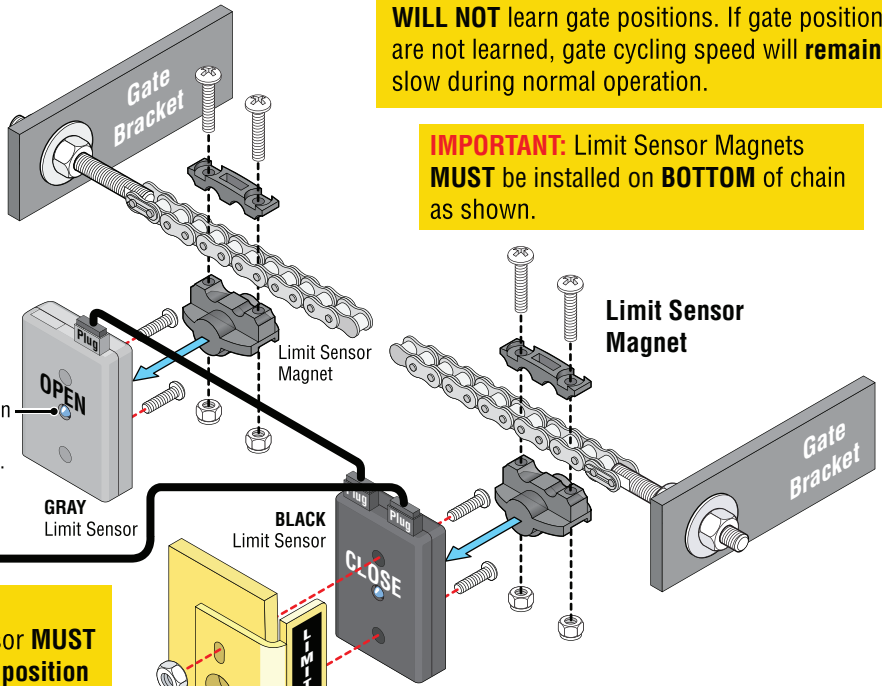

JOG Left/Right Buttons

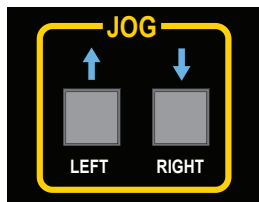

Push and **HOLD** the **JOG LEFT** or **JOG RIGHT** buttons accordingly to move the gate (release the button to stop gate).

Install Limit Sensors:

Use JOG Left/Right Buttons for installation

1. Install **GRAY** sensor on **OPEN** position and **BLACK** sensor on **CLOSE** position as shown.
2. JOG gate to **CLOSE** position.
3. Mark magnet position on chain.
4. JOG gate open slightly and install magnet.
5. JOG gate to **OPEN** position.
6. Mark magnet position on chain.
7. JOG gate closed slightly and install magnet.
8. Gate positions can now be learned, see 7.

SOLAR PACK QUICK INSTALLATION GUIDE

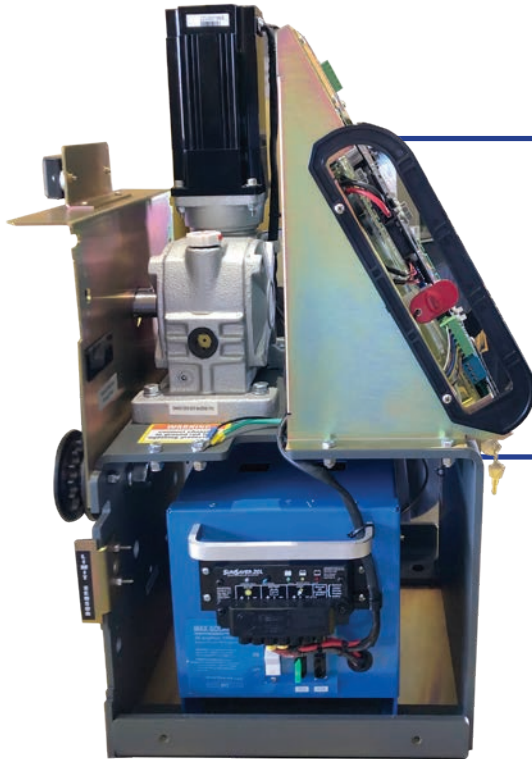

Max Solar Pack
Available for
**ALL SLIDE OPERATORS
PRO SERIES**

Heavy Duty Sheet Metal
Gold Zinc Powder-Coated

Handle

Solar
Regulator
24V, 20A
(Morning
Star)

1 Year Warranty

ON/OFF
Switch

Fuse
30A



AGM Battery
(Absorbant Glass Material)
24V, 36A / Hr
2 x 12V Batteries
YUASA

Power Cable

Power IN/Solar IN
on MATRIX III



UL325
Compliant
UL1741
Compliant

SOLAR PACK QUICK INSTALLATION GUIDE

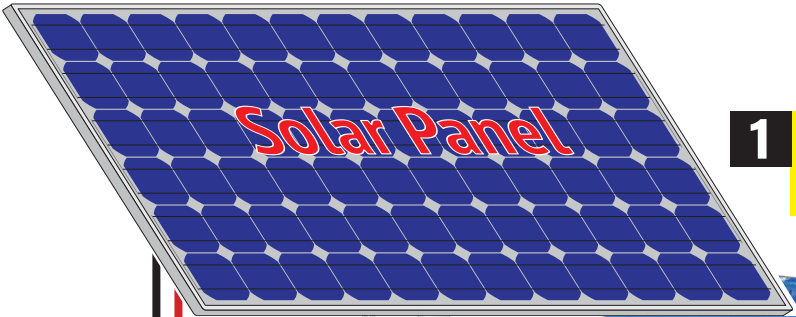

1 Wire solar panel terminals to solar regulator input
Caution: polarity matters

Choose the proper solar panel size according to chart in **step 10** below



V(+)

GND

Power IN/Solar IN on MATRIX III

2 Insert the included fuse into the empty fuse slot (no polarity)

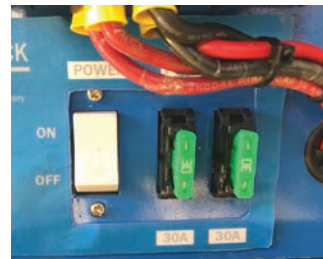
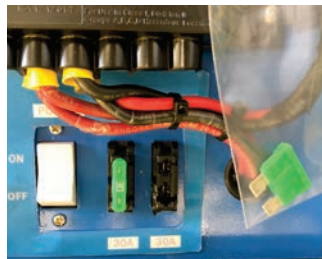

3 Turn "ON" the white switch located to the left of the fuses



4 Leave the solar mode switch "OFF" and follow the included installation manual for standard installation and setup of limit switches

DO NOT TURN ON THE SOLAR MODE SWITCH UNTIL INSTALLATION IS COMPLETED

ON Matrix III

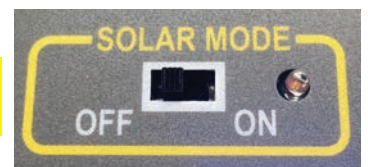

SOLAR PACK QUICK INSTALLATION GUIDE

5 Turn SOLAR MODE ON

Operator will go into low power mode 30 seconds after gate stops moving and loop detectors are not active. While in low power mode:

- All LEDs will turn off except power LED and solar mode LED (blinking)
- 12V DC OUTPUT and 12V DC OUT on 10K port will remain ON, all other power outputs will turn OFF
- EXIT LOOP detector remains ON, center & safety loop detectors are turned OFF.

6 Select low power radio RECEIVER

Power radio receiver using 12V DC OUTPUT
In low power mode, 12V DC OUTPUT is left ON

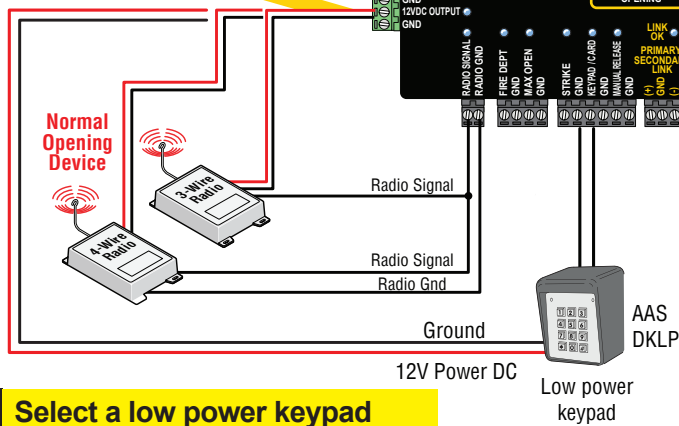

7 Select a low power keypad

8 Select Low Power Loop Detectors

Recommended: Plug-In Loop Detectors
EDI LMA1800-LP

NOTE: While in low power mode, EXIT LOOP detector remains ON, CENTER & SAFETY LOOP detectors are turned OFF

9 OPTIONAL

Remove local 7A/Hr batteries from operator and TURN ON DIP Switch MODE A -1

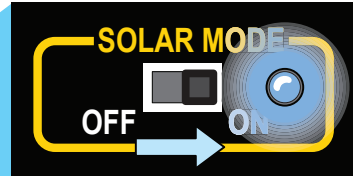
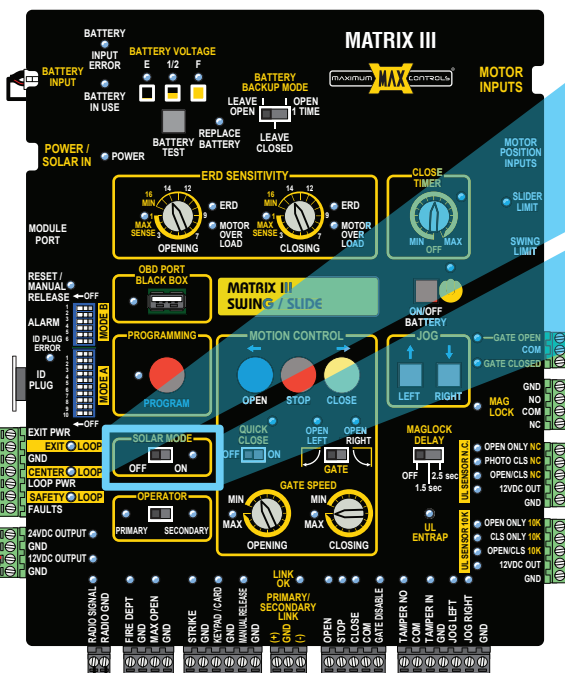

Turn SOLAR MODE ON

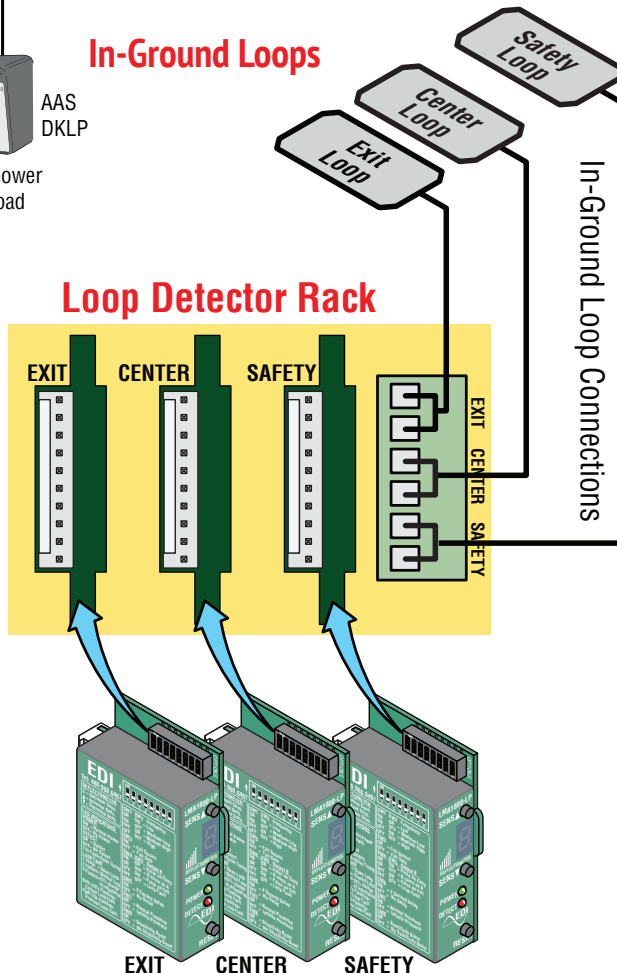

SOLAR PACK QUICK INSTALLATION GUIDE

10 Select proper solar panel

SLIDER, PAD MOUNT, LIGHT GATE

MAX SLIDER PRO		GATE SOLAR CYCLES PER DAY with built-in 36A/Hr battery					
PANEL SIZE	Total System Current Draw (mA)	ZONE 1 (6 Hrs Sunlight/Day)		ZONE 2 (4 Hrs Sunlight/Day)		ZONE 3 (2 Hrs Sunlight/Day)	
		Cycles/day w/1 rainy day	Cycles/day w/10 rainy days	Cycles/day w/1 rainy day	Cycles/day w/10 rainy days	Cycles/day w/1 rainy day	Cycles/day w/10 rainy days
60 W	26	454	85	436	68	418	50
	50	447	79	429	61	411	42
	100	435	66	415	47	395	27
	200	409	41	386	18	364	-5
	250	396	28	372	4	348	-20
85 W	26	475	107	450	82	425	57
	50	469	101	443	75	418	49
	100	456	88	429	61	402	34
	200	430	62	401	32	371	3
	250	418	49	386	18	355	-13
120 W	26	505	137	470	102	435	67
	50	499	130	463	95	428	59
	100	486	118	449	81	412	44
	200	460	92	420	52	381	13
	250	447	79	406	38	365	-3
200 W	26	573	205	515	147	458	90
	50	567	199	509	140	450	82
	100	554	186	494	126	435	66
	200	528	160	466	98	403	35
	250	516	147	452	84	388	20

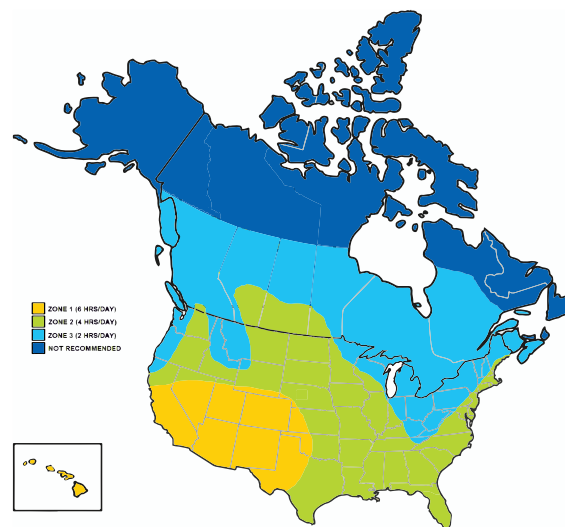

The map and daily cycle rate shown are approximations based upon the average solar radiation and the temperature effects on batteries in the given regions. Local geography and weather conditions may require additional solar panels.

USE LOW POWER accessories in order to minimize power draw. Each additional accessory draws power affecting the daily cycle rate.

SLIDER, PAD MOUNT, HEAVY GATE

MAX SLIDER PRO		GATE SOLAR CYCLES PER DAY with built-in 36A/Hr battery					
PANEL SIZE	Total System Current Draw (mA)	ZONE 1 (6 Hrs Sunlight/Day)		ZONE 2 (4 Hrs Sunlight/Day)		ZONE 3 (2 Hrs Sunlight/Day)	
		Cycles/day w/1 rainy day	Cycles/day w/10 rainy days	Cycles/day w/1 rainy day	Cycles/day w/10 rainy days	Cycles/day w/1 rainy day	Cycles/day w/10 rainy days
60 W	26	302	57	291	45	279	33
	50	298	53	286	41	274	28
	100	290	44	277	31	263	18
	200	273	27	258	12	242	-3
	250	264	19	248	3	232	-13
85 W	26	317	71	300	55	283	38
	50	313	67	295	50	278	33
	100	304	59	286	41	268	23
	200	287	41	267	22	247	2
	250	278	33	258	12	237	-9
120 W	26	336	91	313	68	290	45
	50	332	87	309	63	285	40
	100	324	78	299	54	275	29
	200	307	61	280	35	254	8
	250	298	53	271	25	243	-2
200 W	26	382	136	344	98	305	60
	50	378	132	339	94	300	55
	100	369	124	330	84	290	44
	200	352	107	311	65	269	23
	250	344	98	301	56	259	13



MATRIX III

www.max.us.com

CONFORMS TO UL STD 325
UL CLASS - I, II, III, IV

CERTIFIED TO CAN/CSA STD
C22.2 NO. 247

SAFETY SENSORS REQUIRED



Residential/Commercial Brushless DC Slide Gate Operators

Made in USA



Intertek
4009963

Maximum Controls LLC.
10530 Lawson River Ave
Fountain Valley, Ca 92708
Tel: (949) 699-0220