

MAX Wireless Push Button FOR PRO SERIES

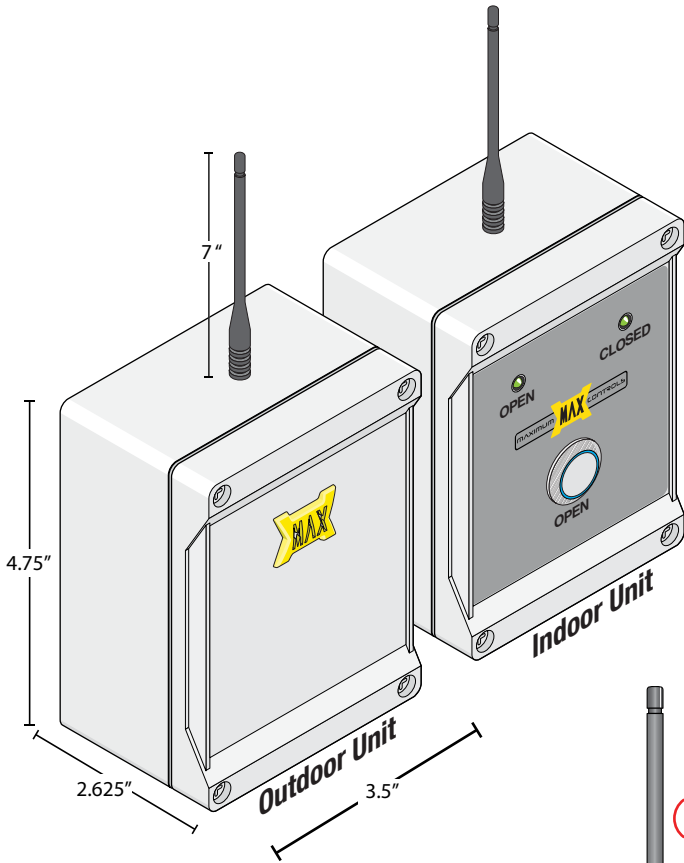

The MAX wireless Open Button is designed to wirelessly **OPEN** or **CLOSE** a gate. It will also monitor the position of the gate with the LEDs.

Press the Open Button to open the gate. Auto-close timer on gate operator will close the gate. If auto-close timer is turned OFF, press open button again to close gate.

Install the indoor unit in a secure place protected from the elements. The outdoor unit gets installed at the gate operator within 3500 feet (Line-of-Sight) of the indoor unit. It can be exposed to the elements. Do not drill any extra holes in the boxes when mounting or running wires to them.

(((900MHz Robust Signal)))
Up to 3500 ft using Line-of-Sight

INDOOR UNIT

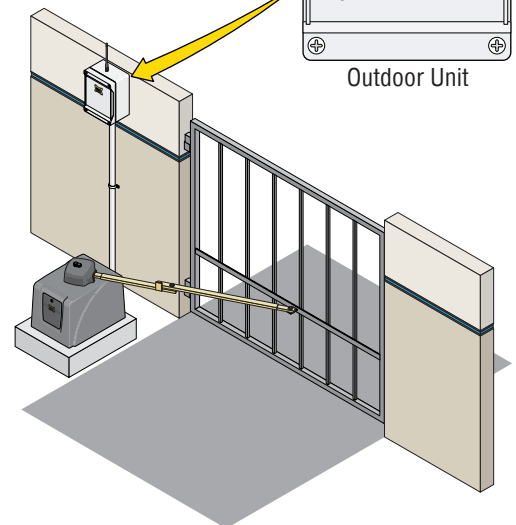
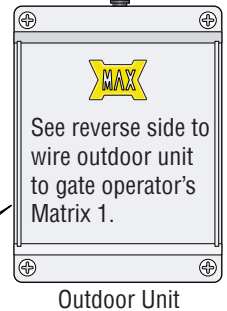
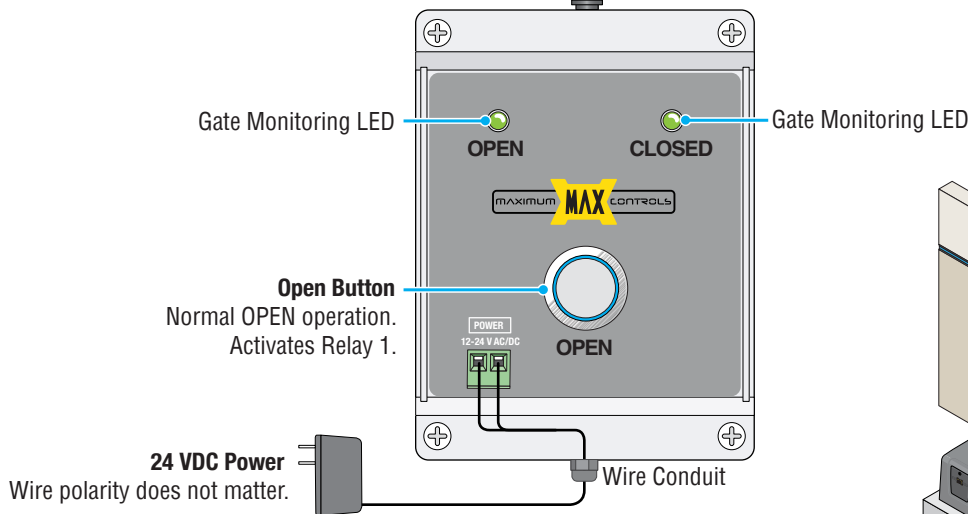

Mount Indoors

in a secure place NOT exposed to the elements.
ONLY use existing 4 holes to mount box.
DO NOT drill any extra holes in box.

MAX Wireless Push Button FOR PRO SERIES



OUTDOOR UNIT

CHANNEL:
ONLY use channels 0 thru 6.
Channels **MUST** match on both units.

RANGE TEST:
Channels **MUST** match on both units.
Must remain OFF during normal operation.

Signal QUALITY:
4 - Excellent
3-4 - Good
2-3 - Poor

Mounting Hole
ONLY use existing 4 holes to mount box.
DO NOT drill any extra holes in box.

Mount at Operator (Outdoors)

Relay 1- C

Relay 1-NO

24 VDC Power
Polarity does not matter.

GROUND Connection:
All inputs are lightning protected when box is properly grounded. Ground to operator chassis or ground rod.

Gate Operator Matrix III

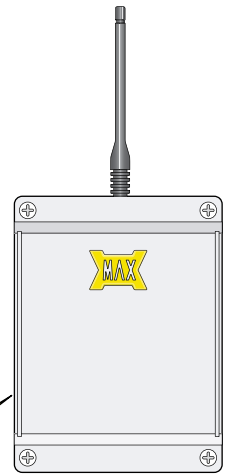
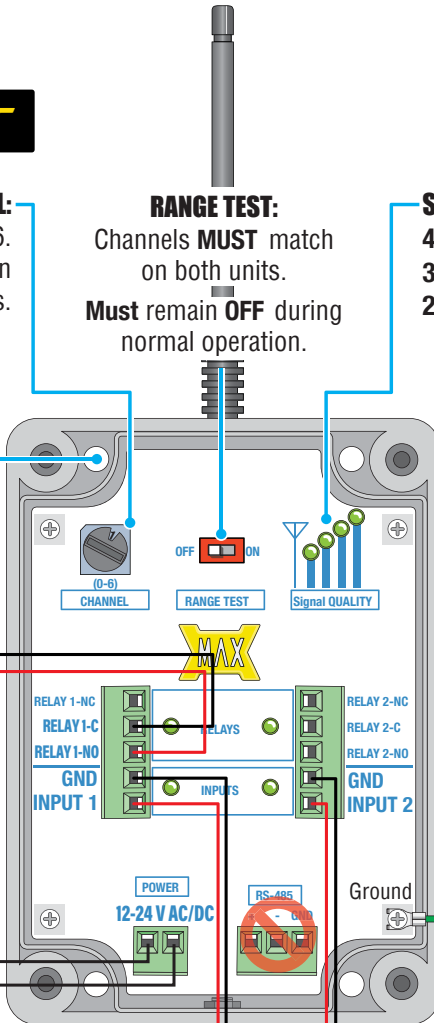
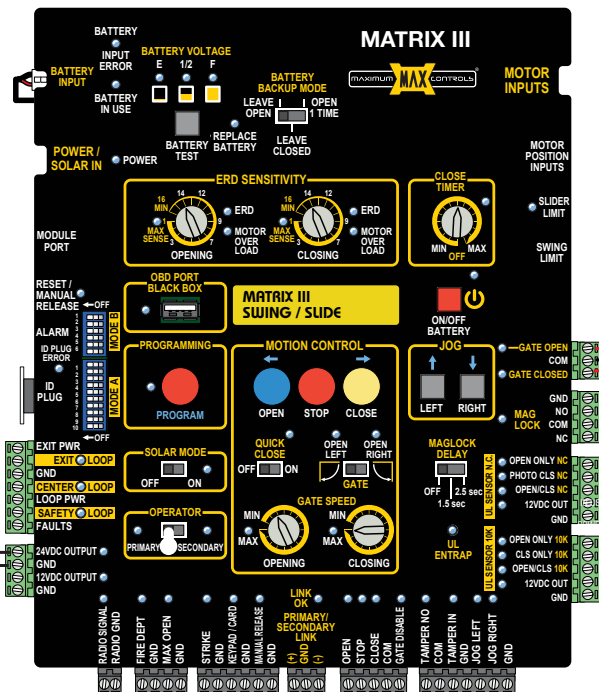

Outdoor Unit

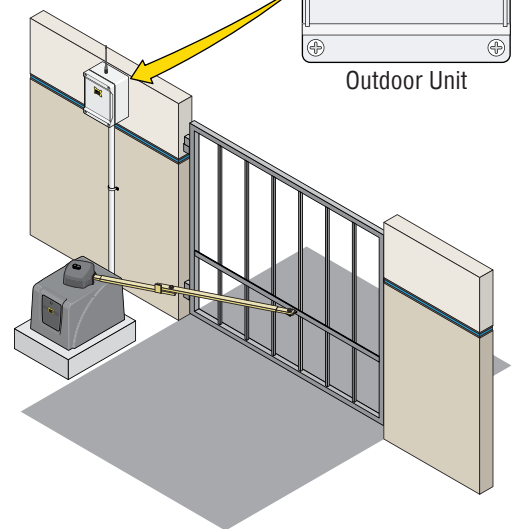

GND
STRIKE