

IP EYE-SIGHT SERIES

The new Eye-Sight series serves the security professionals who are seeking for a professional line featuring outstanding image quality, full connectivity and enhanced video analytics functions based on ARTIFICIAL INTELLIGENCE.



DAI-380IPE-MVF

40M IR 8MP MOTORIZED LENS ANTI VANDAL DOME CAMERA

Equipped with a 2.8-12mm motorized lens and a protective dome, This 8MP camera is designed for medium distance surveillance (up to 40m) in both indoor and outdoor scenarios.

Designed to monitor high-security areas (such as banks, hotels or chain stores) and to capture crimes in the act, the camera features vandal-proof IK10 protection, which makes it extremely hard to sabotage.

The camera offers broad possibilities for Analytics, from Face Detection all the way to the outstanding DDA Analytics (Detect, Distinguish, Alert) which has the ability to perform object recognition and object counting. With a various of detection rules and triggers, DAI-380IPE-MVF camera will help to put an end to false alarms.



MAIN FEATURES

- 8MP
- 3840x2160 Resolution
- 2.8-12mm Motorized Vari-Focal (96°- 32°)
- 3D-DNR
- IP67, IK10
- 2 Way-Audio
- Alarm in + Out

ANALYTICS

- General Analytics: Camera Tampering
- AI (Object Recognition): Humans, 2/4 wheels vehicles
DDA Sterile Area
DDA Line Crossing
DDA Object Counting
- AI (Face Detection): 10 Faces per frame



SPECIFICATIONS

Image Sensor	1/2.8" CMOS (16:9)
Effective Pixels	3840x2160
Electronic Shutter	1/25s ~ 1/100000s
Frame Rate	8MP @ 1-20FPS, 6MP @ 1-20FPS, 5MP @ 1-25/30, 4MP @ 1-25/30, 2MP 1-25/30 in normal mode. 1-50/60FPS in HFR Mode***
Day & Night	ICR
Min. Illumination	0.015 lux (@F1.4, AGC ON) 0 lux with IR on
Audio compression	G.711A/G.711U
Communication	Two-way Audio
Image Settings	AWB, AGC Adjustable, Exposure Mode (Auto) Sharpness, Saturation, Brightness & Contrast Adjustable
Image Enhancement	True WDR**** (120dB), BLC, HLC, ROI
Noise Reduction	3D-DNR
Image Orientation	Mirror/Flip
Privacy Zone	Yes
Motion Detection	Yes
Analytics	General Analytics: Camera Tampering AI (Object Recognition): DDA Sterile Area, DDA Line Crossing, DDA Object Counting AI (Face Detection): 10 Faces per frame
Video Compression	H.265S/H.264S*, H.265+/H.264+/H.265/H.264, MJPEG**
Resolution	8MP / 6MP / 5MP / 4MP / 2MP / 1MP / D1 / QVGA / CIF
Multi-Stream	Master Stream: 8MP(3840x2160) / 6MP(3072x2048) / 5MP(2592x1944) / 4MP(2560x1440) / 2MP(1920x1080) Sub-Stream: 2MP/1MP/D1/CIF/QCIF Third Stream: 1MP/D1/CIF/QCIF (1~30fps)
Bit rate	64Kbps ~ 8Mbps@H.265 / 64Kbps ~ 12Mbps@H.264
Encode Mode	VBR/CBR
Image Quality	Five levels under VBR; Free adjustment under CBR
IR Distance	40m (2 High Power IR LED)
Lens (Field of View)	2.8-12mm MVF with Auto Focus (96° - 32°)

*Main Stream Only, **Sub-Streams Only, ***1080p,no true-WDR

SPECIFICATIONS

Iris	DC Iris (@ F1.4)
Lens Mount	Ø14 Mount
Protection Rate	Water Proof: IP67
Bracket	3-Axis Bracket
Dimensions	Ø140.9x100.3mm
Weight (gross)	~890g
Network	RJ45 (+PoE)
Power	DC Socket
Analog Video Output	CVBS Out + Technician Port
Audio Connectivity	Built-in Microphone + Audio Input + Audio Output
SD Card	Event/Schedule based Main/Sub-Stream recording (Up to 128Gb)
Hard Reset Button	Yes
Alarm	Alarm in + Alarm Out
Remote Monitoring	IE Browsing, CMS Software, Provision Cam2 Mobile App
User Access	Supports simultaneous monitoring for up to 10 users with multi-stream real time transmission
Network Protocol	IPv4, IPv6, TCP, UDP, DHCP, NTP, DDNS, 802.1X, RTSP, Multicast, UPnP, Email, FTP, HTTPS, QoS, P2P
ONVIF	Yes
Ethernet	100Mbps
PoE	Yes
Power Supply	DC12V/~780mA / PoE/~7.4W
Work Environment	-30°C~60°C, 10%~90% Humidity
Junction Box	PR-JB14IP66 - PR-ICB23

DIMENSIONS

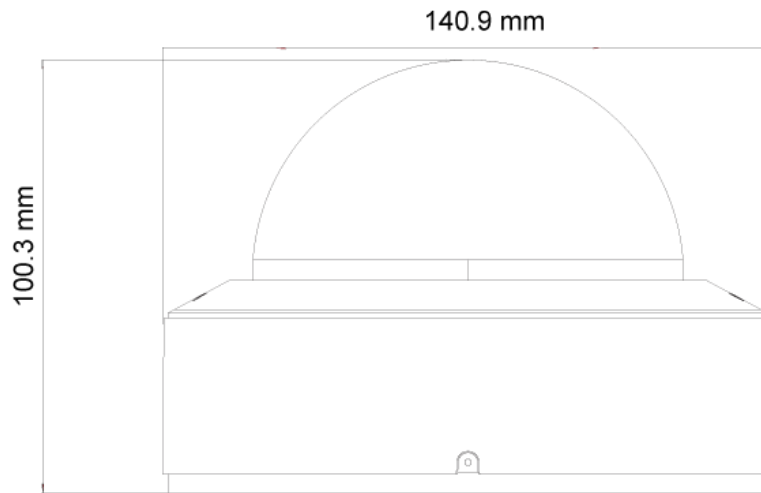

ACCESSORIES



PR-JB14IP66



PR-ICB23