

SL – 1000

SLIDE GATE OPERATOR

INSTALLATION MANUAL



MADE IN U.S.A.

ROTARY GATE SYSTEMS, INC.

ALL RIGHTS RESERVED 2022

REV. 3.1

1-877-331-4RGS (4747)

INTRODUCTION

The Rotary Gate Systems SL-1000 slide gate operator has been designed to be the most reliable and easiest to install product in its field. The straight forward, compact design ensures that this will be the operator of choice for installer, service technicians and customers alike.

The SL-1000 includes these popular features found in today's latest gate operator designs:

- High torque 24 volt DC motor
- Built in battery backup power
- Full systems capable controller
- Built in Instant reversing Sensor
- Easy troubleshooting with easy to interpret LED display
- Continuous duty operation when used on properly installed gates
- Input for non-contact secondary entrapment protection device

In addition, the SL-1000 offers these features not found in any other operator:

- Compact design blends better with surroundings than pad mount operators
- No concrete pad to pour and wait to set up
- No anchors to install
- Operator mounts to gate support post in 15 minutes
- Wear resistant UHMW nylon rack gear means no chain to rust or stretch
- Magnetic reed switches never need adjustment
- Durable powder coated parts provide years of attractive service
- More secure than hydraulic drive rail type operators

Table of contents

Pre-Installation Information	4
Before you begin	
Always check the gate's action	
Gate operator classifications	
Approved obstruction detection device	
Safety Information and Warnings	4
Regulatory warnings	
Wiring specifications	5
AC power wiring	
DC control and accessory wiring	
Earth Ground	5
Safety Information	6
Safety Device Guidelines	6
Access Control Devices	7
Gate Site Layout	7
Limit Switch Profile	8
Mounting operator	
Mounting control box	
Conduits	
Options	
1-Pedestal mounting	
2-Remote mounting	9
Limit switch and magnet installation	
Manual Release	10
Connecting the Operator	11
Field Wiring Description	12
Troubleshooting	13
Contacting technical support	
Operator fails to start	
Motor operates, but gate does not move	
Motor sounds like it is working harder than normal	
Limit switch getting out of time	
Gate stopping part way open or closed	
Gate staying open with automatic system	
Preventative Maintenance	13
Battery maintenance	
General	
Lubrication	
Six-month preventative maintenance	
FCC Notice	13
Programming Manual and Instructions	
Warranty	

Pre-installation Information

Before you begin...

Before unpacking, inspect the carton for exterior damage. If you find damage, advise the delivery carrier of a potential claim. Inspect your package carefully. Claims for shortages will be honored for only 30 days from the date of shipment.

Before installing the operator, read this manual completely to ensure all requirements for proper installation are present. Verify that the voltage to be used matches the voltage of the operator.

If you have any questions about the requirements for proper installation of this gate operator contact technical support at 1-877-331-4747.

Always check the gate's operation.

It's very important before installing the gate operator to make sure the gate slides free and level throughout the entire opening distance. If the gate does not seem to operate properly, it may affect the operator performance or greatly shorten the life of the unit. The gate should also be designed so that airflow is ample to prevent wind resistance and drag.

Gate Operator Classifications

All gate operators can be divided into one of four different classifications, depending on their design and usage. Install this gate operator only when the operator is appropriate for the construction and usage class as defined below:

- **Class I Residential Vehicular Gate Operator**
A vehicular gate operator intended for use in a home or for one to four single family dwellings with a common garage or parking area associated with these dwellings.
- **Class II Commercial/General Access Vehicular Gate Operator**
A vehicular gate operator intended for use in a commercial location or building such as a multi-family housing unit of five or more single family units, hotel, retail store or other building servicing the general public.
- **Class III Industrial/Limited access Vehicular Gate Operator A**
A vehicular gate operator intended for use in an industrial location or building such as a factory or loading dock area or other location not intended to service the general public.
- **Class IV restricted Access Vehicular Gate Operator**
A vehicular gate operator intended for use in a guarded industrial location or building such as an airport security area or other restricted access locations not servicing the general public, in which unauthorized access is prevented via supervision by security personnel.

Approved Obstruction Detection Devices

The following contact or non-contact obstruction detection devices have been approved for use with this slide gate operator as part of a UL325 compliant installation:

- **Contact Edges**
Miller Edge Models MGO20, MGR20, MGS20, ME120,
- **Photoeyes**
MMTC Model IR-55 (165' range) MMTC Model E3K (28' range)

Safety Information and Warnings

THE FOLLOWING FORMATS ARE USED FOR SAFETY NOTES IN THESE INSTRUCTIONS.

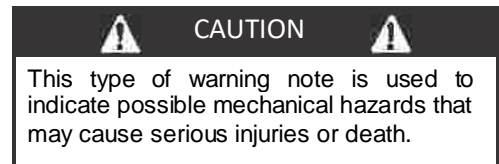
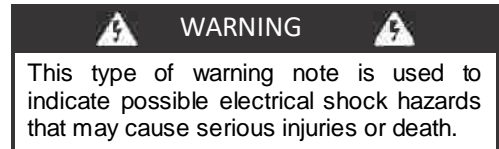
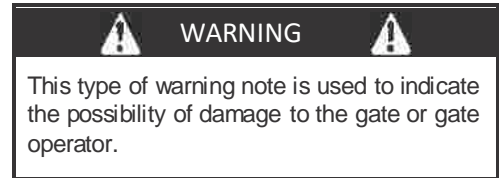

Regulatory Warnings

Read the following before beginning to install this slide gate operator:

IMPORTANT INSTALLATION SAFETY INSTRUCTIONS

TO REDUCE THE RISK OF SEVERE INJURY OR DEATH TO PERSONS, REVIEW THESE INSTALLATION SAFETY STEPS BEFORE PROCEEDING

1. READ AND FOLLOW ALL INSTALLATION INSTRUCTIONS.
2. ALL ELECTRICAL CONNECTIONS TO THE POWER SUPPLY MUST BE MADE BY A LICENSED ELECTRICIAN AND MUST OBSERVE ALL NATIONAL AND LOCAL ELECTRICAL CODES.
3. A separate power-disconnect switch should be located near the operator so that primary power can be turned off when necessary.
4. Install the enclosed warning signs on both sides of the gate. A minimum of two (2) warning signs shall be installed, one on each side of the gate where easily visible.
5. Never reach between, through or around the fence to operate the gate.
6. Never connect a button station within reach of the gate or on the side of the gate operator.
7. Do not adjust the operator controller's current sensing feature too high. It should be adjusted high enough to keep the gate from falsely triggering the sensing, but no higher than necessary for the gate to operate. DO NOT DEFEAT THE PURPOSE OF THIS FUNCTION!
8. You must install all required safety equipment.
9. UL325 Compliance requires the use of contact edges or photoelectric controls on all automatic or remotely-controlled gate operators.
10. The operator is intended for installation only on gates used for vehicles. Pedestrians must be supplied with a separate access opening. The pedestrian access opening shall be designed to promote pedestrian usage. Locate the gates such that persons will not come into contact with the vehicular gate during the entire path of travel of the vehicular gate.

Wiring Specifications

Refer to the following steps for details on power and accessory wiring for the operator.

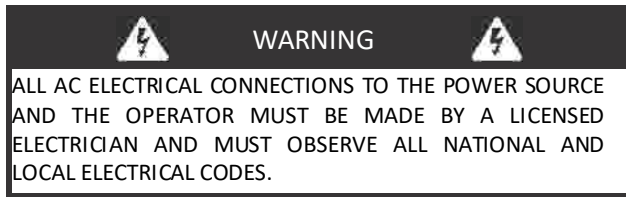

USE COPPER WIRE ONLY!

AC Power Wiring

1. Connect power in accordance with local codes. The green ground wire must be properly connected.
2. Wire insulation must be suitable to the application.
3. Electrical outlets are supplied in all models for convenience with occasional use or low power consumption devices only.

DC Control and Accessory Wiring

1. All control devices are 24 VDC, which can be run up to 2000 feet with 14 AWG wire.
2. Control wiring must be run in a separate conduit from power wiring. Running them together may cause interference and faulty signals in some accessories
3. A three-wire shielded conductor cable is required to connect two operators together for dual operation. You must use Beldon 8760 Twisted Pair shielded Cable (or equivalent) only (P/N 2500-1982, per foot).

Note: The shield wire should be connected in both the operators.

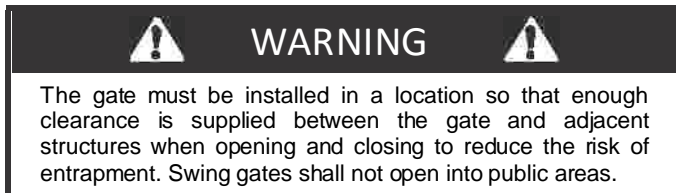

CONTROL BOX POWER SPECIFICATIONS

INPUT AC POWER/AMPS

SL-1000 Commercial	115 VAC 6.8 amps
SL-1000i Industrial	115 VAC 5.9 amps

POWER OUTPUT

SL-1000 Commercial	24 VDC / 14.6 amps / 350.4 watts
SL-1000i Industrial	27 VDC / 18.6 amps / 502.2 watts

Earth Ground

Install a ground rod and connect it to the operator's control box in every gate operator installation. A good earth ground is necessary to allow the controller's built-in surge and lightning protection circuitry to work effectively.

All ROTARY GATE SYSTEMS gate operators are supplied with a power disconnect switch to turn on and off the power available to the operators. Following wiring specifications below, incoming power should be brought into the operator and connected to the appropriate wires from the disconnect box.

***NOTE:** Do not splice the ground wire. Use a single piece of solid copper 12 AWG wire between the ground rod and the operator.

1. Install an 8-foot long copper ground rod next to the operator control box.
2. Use a clamp to connect a solid copper 12 AWG ground wire to the ground rod.
3. Route the ground wire to the operator control box.
4. Connect the ground wire to the operator's control box.

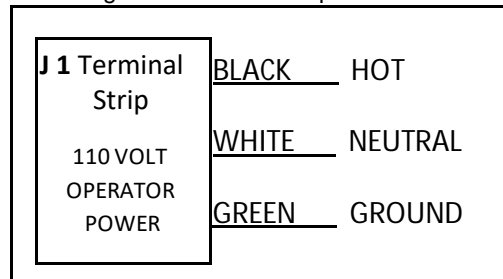

Safety Information

Gate system designers, sellers, installers, technicians, and users should familiarize themselves with the proper layout designs required to ensure the safe operation of the gates and any accessories associated with them. Any gate system design must include safety devices of sufficient quantity and placement to protect the customer, the general public and technicians working on the system from potential harm. Use the following guidelines to help with the design of the gate layout.

- Always install non-contact safety sensors (magnetic loops, photo beams) in the proper locations to eliminate any potential entrapment points.
- Always install at least 2 WARNING SIGNS (one on each side of the gate in a clearly visible location).
- Always install guards over any exposed rollers.
- To comply with ASTM F2200 requirements, the gate should be designed such that a sphere 2 ¼ “ cannot pass through any portion up to a height of 60” from ground level.
- Before installing the gate and operator, verify:
 - The gate design is appropriate for the site and type of usage
 - The gate operator is appropriate for the type of gate and usage level.
 - The appropriate controls and safety devices have been included in the layout of the system.
 - A separate pedestrian gate has been included in the gate layout in a position safe from contact with the vehicular gate when it is in the full open position.
- Verify that the gate is able to move freely by hand before attempting to install the gate operator. Correct any tight spots in the movement of the gate before proceeding.
- Any controls used to open the gate must be located at least 7' from any portion of the moving gate to keep a user from attempting to reach through, under, over, or around the gate to activate the control.

Safety Device Guidelines

All automatic gate operator installations shall comply with the latest version of UL325 safety standards with regard to safety device type and operation. Refer to Table 31.1 below.

Table 31.1
Protection against entrapment

Revised Table 31.1 effective January 12, 2015

Usage class	Gate operator category			
	Horizontal slide, vertical lift, and vertical pivot		Swing and vertical barrier (arm)	
	Primary type ^a	Secondary type ^a	Primary type ^a	Secondary type ^a
Vehicular I and II	A	B1, B2, or D	A, or C	A, B1, B2, C, or D
Vehicular III	A, B1, or B2	A, B1, B2, D, or E	A, B1, B2, or C	A, B1, B2, C, D, or E
Vehicular IV	A, B1, B2, or D	A, B1, B2, D, or E	A, B1, B2, C, or D	A, B1, B2, C, D, or E

Note – The same type of device shall not be utilized for both the primary and the secondary entrapment protection means. Use of a single device to cover both the opening and closing directions is in accordance with the requirement; however, a single device is not required to cover both directions. A combination of one Type B1 for one direction and one Type B2 for the other direction is the equivalent of one device for the purpose of complying with the requirements of either the primary or secondary entrapment protection means.

^a Entrapment protection types:

Type A – Inherent entrapment protection system. See 31.1.5.

Type B1 – Provision for connection of, or supplied with, a non-contact sensor (photoelectric sensor or the equivalent). See 31.1.6 – 31.1.9.

Type B2 – Provision for connection of, or supplied with, a contact sensor (edge device or the equivalent). See 31.1.7 and 31.1.10 – 31.1.12.

Type C – Inherent adjustable clutch or pressure relief device. See 31.1.13.

Type D – Provision for connection of, or supplied with, an actuating device requiring continuous pressure to maintain opening or closing motion of the gate. See 31.1.14 and 31.1.15.

Type E – An audio alarm. See 31.1.7, 31.1.16, 31.1.17, and 31.1.18.

Access Control Devices

The SL-1000 is compatible with any type of access control device which provides a dry contact relay for activation.

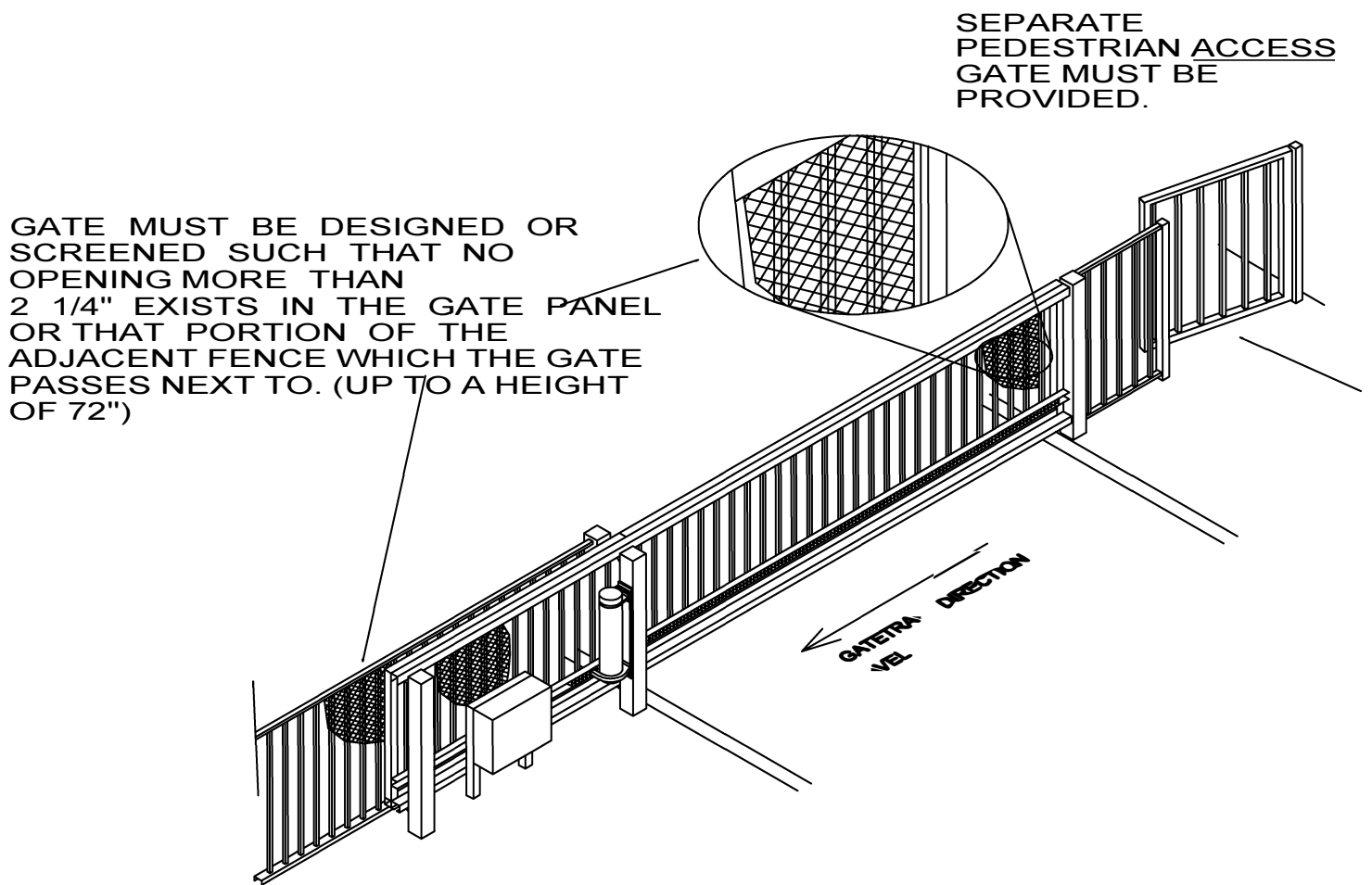

GATE SITE LAYOUT

Mounting Operator

The SL-1000 mounts directly to one of the gate support posts, if using a cantilever gate, or to an auxiliary mounting post, if no gate support post is available.

1. Decide on a location for the operator; front post, rear post, separate auxiliary post.
2. With the gate in the full closed position, mark the rack gear channel approximately one foot toward the rear of the gate from where the SL-1000 will be mounted.
3. Move the gate to full open position. Mark the rack gear channel approximately one foot toward the front of the gate from where the SL-1000 will be mounted.
4. Install rack gear between the two marks. Normal length of rack gear is: gate opening width plus 2'. Secure the rack gear into the channel with self-drilling screws and/or high strength construction adhesive. A combination of screws into the holes in the teeth of the rack gear and some down through the top of the channel into the rack gear is recommended.
5. With the rack gear mounted to the gate, mark a line on the gate support post where the operator will be mounted 22 1/4 " above the CENTER of the rack gear. This will represent the top of the SL-1000 mounting plate.
6. Align the top of the mounting plate with the mark made in step 5. Clamp the mounting plate to the support post.
7. Using a 5/16" drill, drill a hole into the post through each of the four holes in the mounting plate. Tap the holes using a 3/8-16 tap. (This step may be eliminated if welding the mounting plate to the support post.)
8. Bolt the mounting plate to the gate support post using four 3/8-16 x 1" bolts with washers.
9. Loosen the two 3/8 nuts securing the SL-1000 to the mounting plate. The operator can now be adjusted to mesh with the rack gear on the gate. When meshing the pinion gear with the rack gear on the gate, allow approximately 1/16 " clearance between the two. The pinion gear guard may need to be reversed. If necessary, remove the guard using the supplied 5/32" allen wrench to remove the guard from mounting angle on the support plate. Then remove the side angle from the guard. Reinstall the side angle on the opposite side and reinstall the guard onto the mounting angle.
10. The operator installation is now complete.

Mounting Control Box

General

The SL-1000 control box is separate from the operator to allow for easy mounting in a convenient location and to allow for locating it on columns or walls up to 25 feet away from the gate with the proper wire.

Conduits

The SL-1000 control box provides knock outs in the bottom of the box for installation of conduit. Please note that the batteries are also located in the bottom of the control box and install conduits accordingly.

Option 1: Pedestal Mounting

The SL-1000 control box can be mounted to any suitable support (column, wall, post, pedestal). The optional powder coated aluminum pedestal is designed for easy installation of the control box and limit switches when mounted in line with the gate (see Fig. 4).

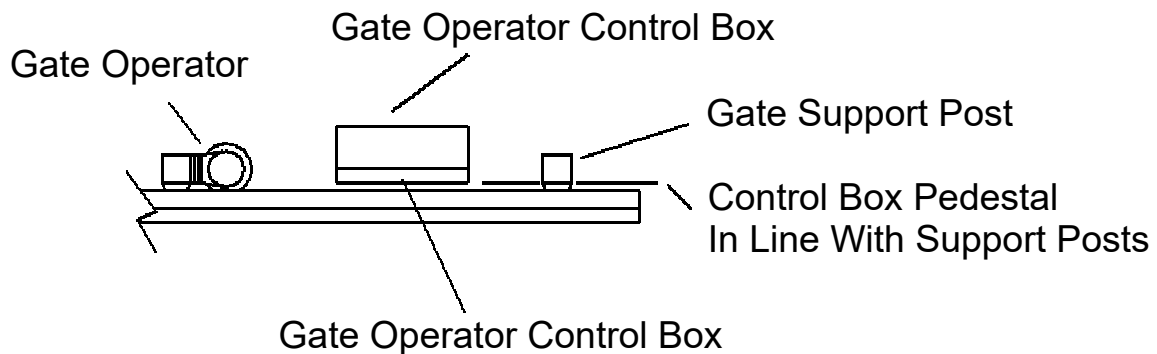

CONTROL BOX PEDESTAL MOUNTING

Option 2: Remote Mounting

If mounting the SL-1000 control box remotely from the gate, run wires from the control box for the operator motor, limit switches, photo beams, loops and opening accessories. Power and low voltage wiring should always be installed in separate conduits.

Limit Switch and Magnet Installation

The magnetic reed switches used with the SL-1000 can be mounted to the back of the optional aluminum control box pedestal or secured to one of the gate support posts. Mounting the limit switches and corresponding magnets, remember that the magnets will activate the switches when the two come to within 1-1/2" of each other (see Fig. 5). Note that limit switches are normally closed (N/C) when not activated. Black wires from limit switches connect to COMMON terminal limit switch input on Terminal Strip J1. The red wires from limit switches connect to OPEN and CLOSE terminals respectively.

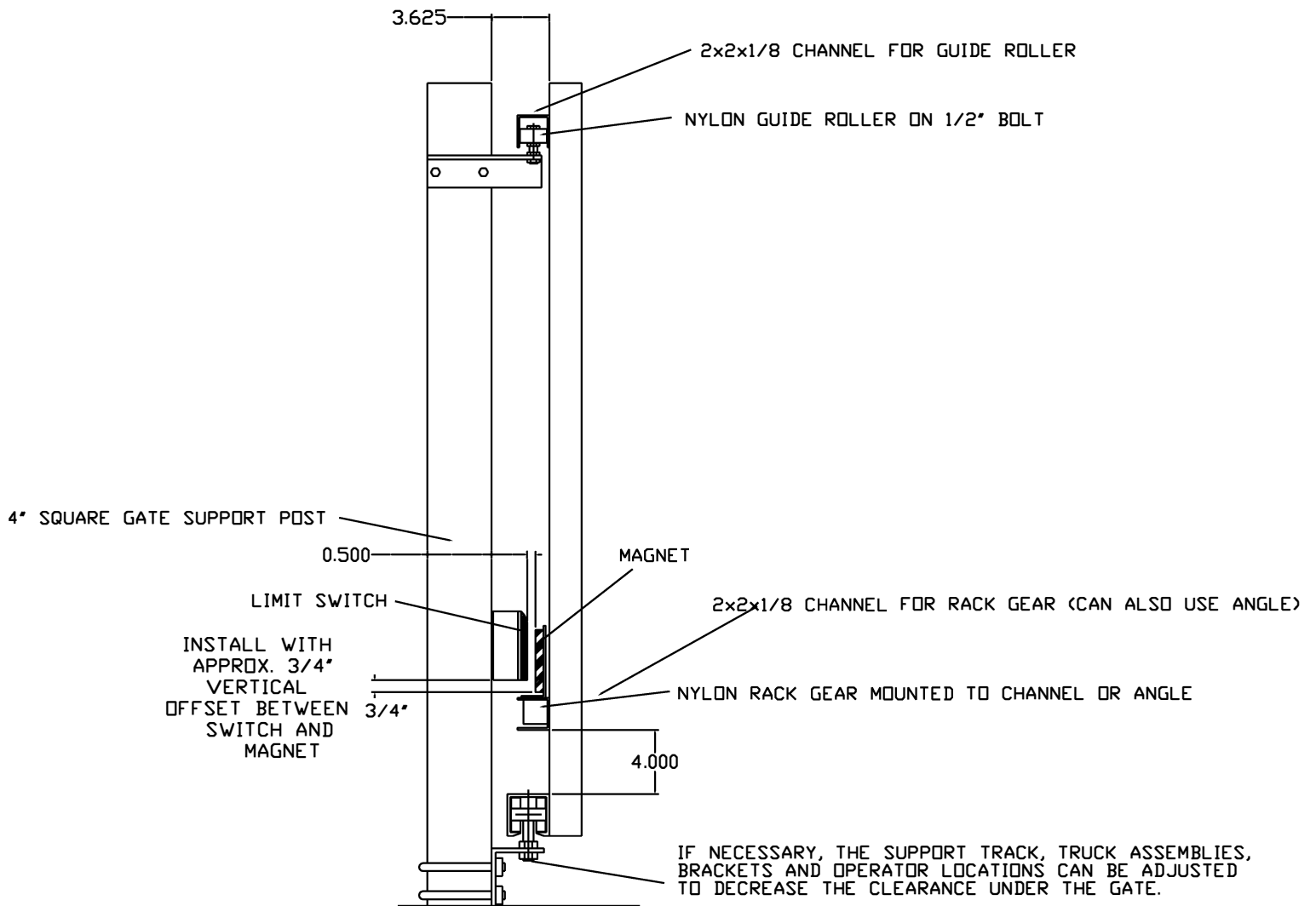

SL-1000 LIMIT SWITCH PROFILE (GATE DESIGN AND DIMENSIONS MAY VARY)

MANUAL RELEASE

This gate operator is equipped with a manual release device which requires no tools. To open the gate manually:

1. Turn power switch inside control box OFF before proceeding!
2. To disengage operator and move gate manually, lift keylock cover on top cap, insert key and turn clockwise. Remove cap.
3. Rotate the 3 prong cam counter-clockwise until it locks into place. The gate may now be moved freely by hand.
4. Move gate to desired position and reengage the operator by rotating the cam clockwise. Move gate slightly to engage drive mechanism inside operator.
5. Replace cap and remove key. The cap must be replaced to protect the internal components. The key must be turned to the locked position before it can be removed.
6. The operator can be restarted from any position as the limit switches are controlled by the position of the gate, not the operator.

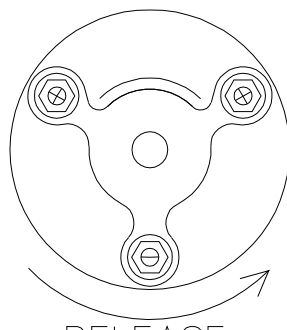

RELEASE

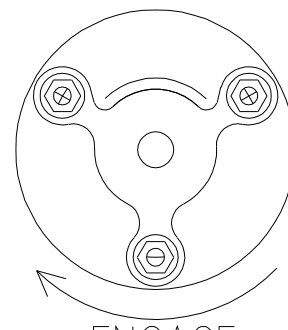

ENGAGE

CONNECTING THE OPERATOR

After the operator and control box are mounted, connect the operator wires to the APeX control panel. A flex conduit fitting is provided on the bottom for the operator and an additional fitting is included in the accessory bag included with each operator. Use standard non-metallic flex conduit (not provided) to go from the operator to the control box or to a junction box (not provided) which can be mounted on the support post below the operator.

If necessary, the motor wires and brake wires from the operator can be added to in order to reach the control box. If this is required, use minimum 16 ga. wire for the motor wires (the black and red conductors in the black shield) and minimum 18 ga. wire for the brake wires (the black and red conductors in the white shield).

Once the motor and brake wires have been routed into the control box, connect the wires from the operator to the two terminals labeled "MOTOR" on Terminal J1. Although the APeX control can be programmed for left / right hand operation, it may be necessary to reverse the motor leads at this connection. Switching from Left to Right in programming the Apex controller only changes the configuration of the limit switches, not the motor run direction.

After the motor wires have been connected, connect the brake wires. The red and black brake wires connect to the terminals labeled "BRAKE" on Terminal J1. These wires are not polarity sensitive.

WARNING: DO NOT ATTEMPT TO RUN THE OPERATOR UNTIL THE BRAKE IS RELEASED.

FIELD WIRING LAYOUT

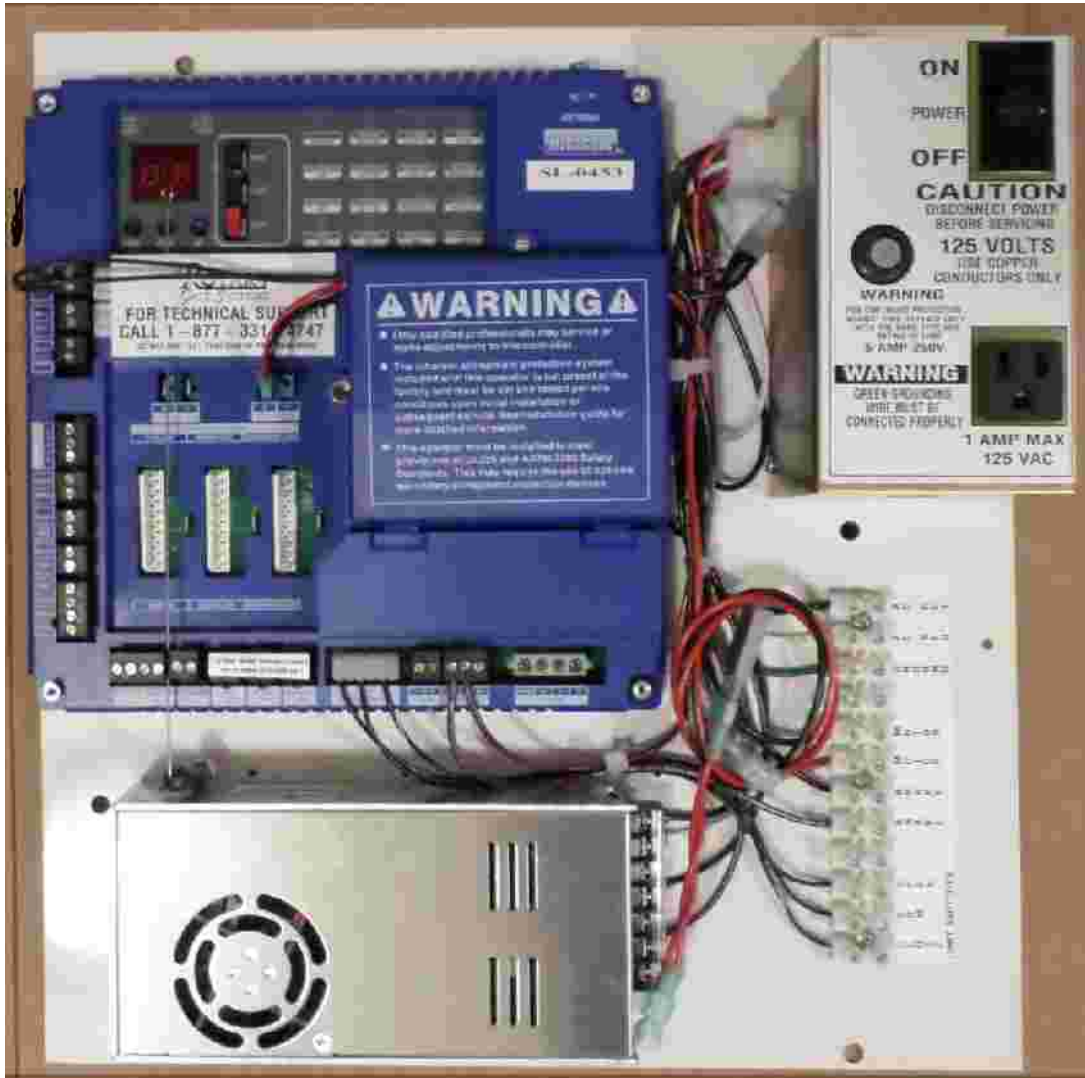

THE FOLLOWING TERMINALS ARE LABELED FOR FIELD CONNECTION:

BATTERY (WIRES): Connect to (2) 12v5ah batteries found in accessory box. Connect red to positive (+) side of one battery, black to negative (-) terminal on other battery, and connect jumper between remaining terminals on batteries to provide 24 vdc battery backup and motor power.

LIMIT SWITCHES: Connect to the wires from the limit switches. The wires are labeled.

BRAKE Connect to brake wires on operator.

MOTOR : Connect to black and red wires coming from motor. If it is necessary to extend the motor wires, use minimum 16 ga. wire. If motor runs the wrong direction, reverse the black and red wires.

110 AUX. POWER: Connect any 110 vac auxiliary devices.
(WIRES)

110 POWER: Connect incoming 110 vac power. Electrical power must be installed by a qualified electrical contractor.
(AC HOT, AC N, GROUND)

Troubleshooting

Contacting Technical Support

For technical questions regarding ROTARY GATE SYSTEMS gate operators, please contact the Technical Support Department at 1-877-331-4747.

Operator fails to start

- A. Make sure you have power at the master distribution panel and that the power has not been turned off.

Motor operates, but gate does not move

Motor sounds like it is working harder than normal

- A. Make sure the gate is moving freely and without binding throughout its entire travel.

Gate stopping part way open or closed (but no visible obstruction)

- A. The controller may have received a false obstruction input triggered by current sensing set too low. Make sure the gate moves freely through its entire travel before adjusting the current sensing.
- B. The Maximum Run Timer may have counted down and expired. This can be caused by having the timer set too low. When the timer expires, the gate stops and the beeper will sound.
- C. An obstruction signal from an accessory wired to the obstruction input may have triggered falsely. Check the control board for lit indicators for any of the following inputs: safety, shadow/reset, open obstruction, close obstruction, stop, etc. If any are lit when the operator should be running, remove all devices hooked to that function and hook them up one at a time and try to run the operator until the problem device is found

Gate staying open with automatic system

- A. If vehicle detectors are used with the operator, one of the loops or loop detectors may be sending a false signal or needs to be reset. Observe the indicators on the loop detector. Unplug the detector and try running the operator.
- B. An opening or reversing device may be stuck or malfunctioning. Try disconnecting these devices and hook them back up one at a time and try running the operator until the malfunctioning device is found.
- C. Make sure the close limit switch isn't activated. If it is, the operator will think the gate is already closed.
- D. Any input into the Fire Dept terminal on the APeX controller will open the gate and hold it open. This will be indicated by EN 04 on the APeX display. To clear this error, press the RESET button on the outside of the control box and give the system an OPEN or CLOSE signal.

Model SL-1000 Maintenance

Battery Maintenance

The gel-cell batteries in this operator require no routine maintenance. For assured continued performance, they should be replaced every year. If power is to be removed for one week or more, disconnect the negative wire from the batteries as this will prevent deep discharging. Fully charge before use, after storage or upon initial installation.

Preventative Maintenance

Always disconnect power from operator before servicing. Keep clear of gate during operation.

General

RGS gate operators are designed for many years of trouble-free operation, and, under recommended operating conditions, will require only minimal maintenance. To ensure that unit is ready for operation at all times, and to preclude seri damage or failure, inspect the unit systematically. Proper adjustments should be made as recommended.

For all gate operators, you must inspect the gate for proper operation. The gate should move easily without binding through its entire travel. If the gate does bind, adjust or fix as required.

Failure to keep the gate in good working condition will have adverse effects on the operator.

Six-Month Preventative Maintenance

1. Inspect all nuts and bolts for proper tightness and tighten as necessary.
2. Check all reversing devices for proper function. Inspe all contact edges for wear and replace if required. Check photoeyes for proper alignment and function.
3. Check current sensing for proper adjustment when finished with inspections and maintenance.
4. Inspect the installation area. Are all the warning signs

FCC Notice

This device complies with RCC Rules Part 15 and Industry Canada Rules & Regulations. Operation is subject to the following two conditions: (1) this device may not cause harmful interference and (2) the device must accept any interference received, including interference that may cause undesired operation.

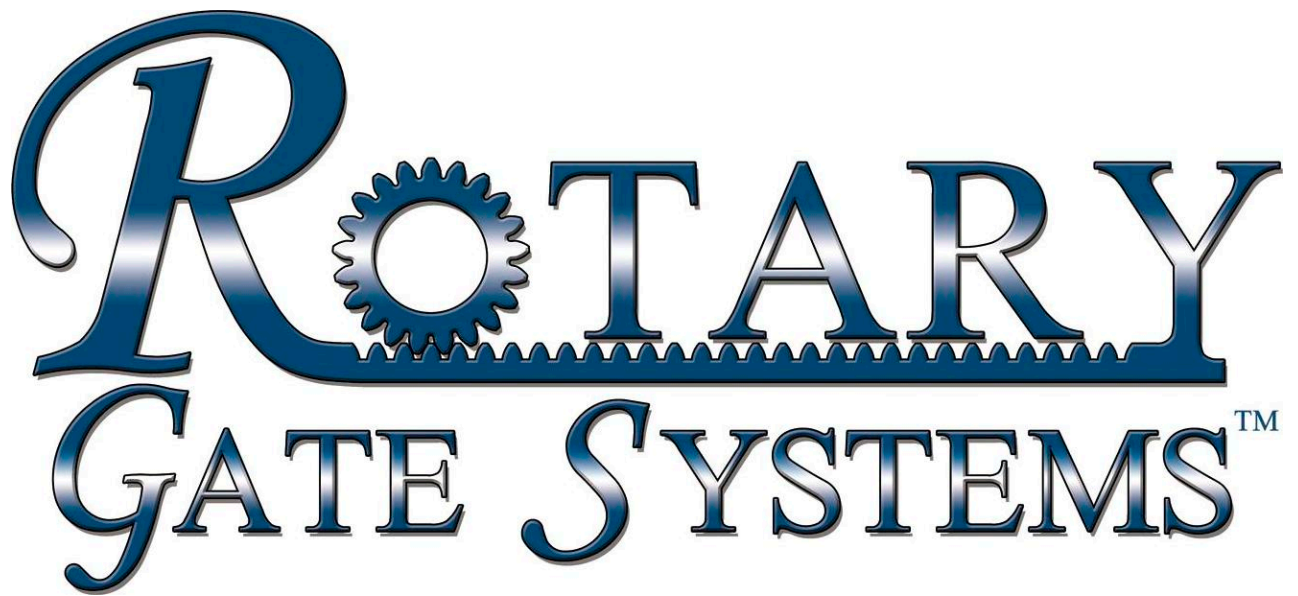

SL – 1000

SLIDE GATE OPERATOR

PROGRAMMING MANUAL

Controller Features

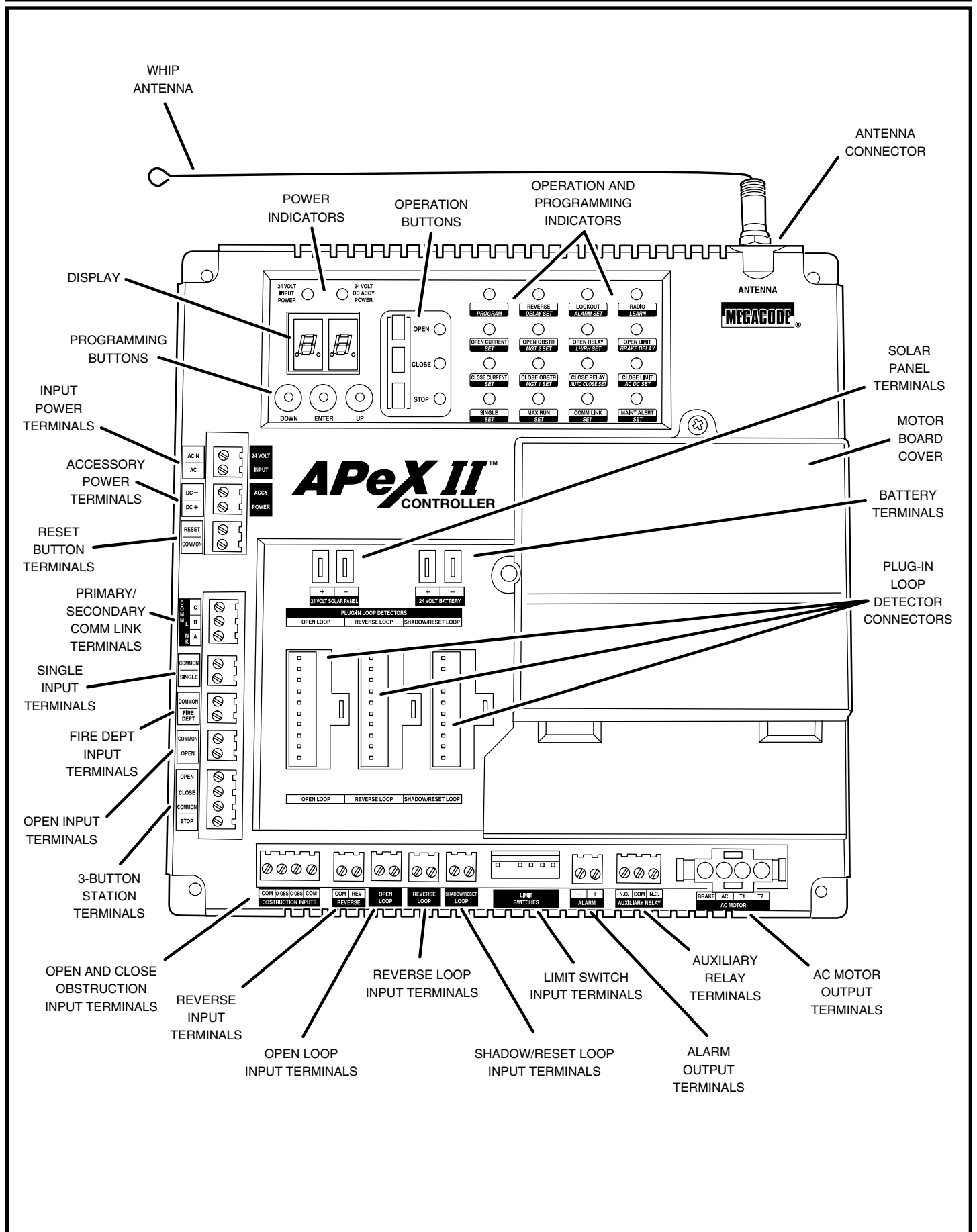



































Figure 10. Controller Features

Indicator Descriptions

INDICATOR DEFINITION		INDICATION WHEN LIT DURING NORMAL OPERATION	INDICATION WHEN LIT DURING PROGRAMMING
OPERATION	PROGRAMMING		
24 VOLT INPUT POWER		LOW VOLTAGE AC POWER IS PRESENT	
24 VOLT DC ACCY POWER		LOW VOLTAGE DC POWER IS PRESENT	
OPEN		OPEN SIGNAL PRESENT FROM THE INTERNAL RECEIVER OR AN EXTERNAL DEVICE CONNECTED TO THE OPEN INPUT TERMINAL	
CLOSE		CLOSE SIGNAL IS PRESENT FROM A DEVICE CONNECTED TO THE CLOSE INPUT TERMINAL	
STOP		STOP INPUT TERMINAL IS OPEN AND NOT CONNECTED TO COMMON	
PROGRAM			CONTROLLER IS IN PROGRAMMING MODE
REVERSE	DELAY SET	SIGNAL FROM REVERSING DEVICE IS PRESENT	SET REVERSE DELAY TIME
LOCKOUT	ALARM SET	CONTROLS AND OPERATOR ARE LOCKED OUT BECAUSE OF EXISTING TROUBLE CONDITION	SET RUN ALARM AND PRE-START ALARM
RADIO	LEARN	BUILT-IN RECEIVER IS DETECTING A RADIO SIGNAL FROM A REMOTE CONTROL	TRANSMITTERS CAN BE ENTERED INTO MEMORY (UP TO 40 TRANSMITTERS)
OPEN CURRENT	SET	MOTOR CURRENT HAS EXCEEDED THE OPEN CURRENT SETTING WHILE OPENING	SET MAXIMUM OPEN CURRENT
OPEN OBSTR	MGT 2 SET	OPEN OBSTRUCTION TERMINAL CONNECTED TO COMMON BY BEAM OR SAFETY EDGE, OR SIGNAL FROM MGT OBSTACLE TRANSMITTER	SET MGT #2 FUNCTION
OPEN RELAY	LH/RH SET	OPEN RELAY IS ACTIVATED	SET LEFT-HAND RIGHT-HAND OPERATION
OPEN LIMIT	BRAKE DELAY	OPEN LIMIT SWITCH IS ACTIVATED	
CLOSE CURRENT	SET	MOTOR CURRENT HAS EXCEEDED THE CLOSE CURRENT SETTING WHILE CLOSING	SET MAXIMUM CLOSE CURRENT
CLOSE OBSTR	MGT 1 SET	CLOSE OBSTRUCTION TERMINAL CONNECTED TO COMMON BY BEAM OR SAFETY EDGE, OR SIGNAL FROM MGT OBSTACLE TRANSMITTER	SET MGT #1 FUNCTION
CLOSE RELAY	AUTO CLOSE SET	CLOSE RELAY IS ACTIVATED	SET AUTO-CLOSE TIME
CLOSE LIMIT	AC DC SET	CLOSE LIMIT SWITCH IS ACTIVATED	SET MOTOR TYPE
SINGLE	SET	SINGLE TERMINAL CONNECTED TO COMMON BY AN EXTERNAL PUSHBUTTON OR RADIO	SET SINGLE BUTTON INPUT FUNCTION
MAX RUN	SET	MAXIMUM RUN TIMER HAS BEEN EXCEEDED	SET MAXIMUM RUN TIME
COMM LINK	SET	DUAL OPERATOR CONNECTION DETECTED, BLINKS IF CONNECTION HAS FAILED	
MAINT ALERT	SET	MAINTENANCE IS REQUIRED ON OPERATOR	SET MAINTENANCE ALERT CYCLE COUNT

APEX FUNCTION DISPLAY INDICATIONS

 "RL" LEFT OR RIGHT HAND OPERATION	 "RT" MAXIMUM RUN TIMER	 "CP" CONSTANT PRESSURE MODE	 "TL" LEARN TRANSMITTERS
 "PM" SINGLE OR DUAL GATE	 "SB" SINGLE BUTTON INPUT SETUP	 "SP" SHADOW LOOP OPEN INHIBIT	 "TD" DELETE TRANSMITTERS
 "AC" AUTO CLOSE TIMER	 "SM" STAGGER MODE	 "CT" RESET CYCLE COUNT	 "ML" LEARN MGT TRANSMITTERS
 "RP" RUN ALARM PRE-START ALARM	 "ST" STAGGER TIME	 "MA" MAINTENANCE ALERT TRIGGER	 "MD" ERASE MGT TRANSMITTERS
 "OC" MAXIMUM OPEN CURRENT	 "AR" AUXILIARY RELAY MODE	 "MT" MID-TRAVEL STOP POSITION	 "MO" MOTOR TYPE SELECTION
 "CC" MAXIMUM CLOSE CURRENT	 "RD" REVERSE DELAY TIME	 "AT" ANTI-TAILGATE ENABLE	 "CL" RESET TO FACTORY DEFAULTS
 "AD" ADVANCED PROGRAMMING	 "BD" BRAKE DELAY TIME	 "RA" RADIO ENABLE	 "OT" OBSTRUCTION DETECTION TYPE, b1, b2
 "OO" OPEN OBSTRUCTION INPUT ACTIVE	 "CO" CLOSE OBSTRUCTION INPUT ACTIVE	 "RO" REMOTE OPEN OBSTRUCTION ACTIVE	 "RC" REMOTE CLOSE OBSTRUCTION ACTIVE
 "MM" MGT MONITORING FUNCTION			

Terminal Descriptions

TERMINAL	GROUP	FUNCTION
AC N AC	24 VOLT INPUT	FACTORY CONNECTED TO 24 VAC FROM 24 VDC FROM CONTINUOUS DUTY DC SUPPLY.
DC - DC +	ACCESSORY POWER	PROVIDES 24 VOLT DC POWER FOR ACCESSORIES. (.5A MAX)
RESET COMMON	RESET BUTTON	FACTORY CONNECTED TO THE CONTROLLER'S RESET BUTTON.
C B A	COMM LINK	FOR 3-WIRE NETWORK CONNECTION TO SECOND OPERATOR IN DUAL GATE INSTALLATIONS.
COMMON SINGLE	SINGLE BUTTON INPUT	CONNECT TO NORMALLY OPEN SWITCH FOR SINGLE BUTTON OPERATION. ALTERNATES BETWEEN OPEN-CLOSE OR OPEN-STOP-CLOSE DEPENDING ON PROGRAMMING.
COMMON FIRE DEPT	FIRE BOX INPUT	CONNECT TO NORMALLY OPEN SWITCH IN FIRE BOX FOR FIRE DEPARTMENT ACCESS.
COMMON OPEN	OPEN INPUT	CONNECT TO NORMALLY OPEN DEVICES (KEYPAD, CARD READER, KEYSWITCH, TELEPHONE ENTRY SYSTEM) TO OPEN THE GATE. A CONSTANT OPEN INPUT WILL OVERRIDE THE MID-TRAVEL STOP AND HALT THE AUTO CLOSE TIMER UNTIL RELEASED.
OPEN CLOSE COMMON STOP	3-BUTTON STATION INPUT	CONNECT TO 3-BUTTON STATION FOR OPEN-CLOSE-STOP CONTROL. A CONSTANT OPEN INPUT WILL OVERRIDE THE MID-TRAVEL STOP AND HALT THE AUTO CLOSE TIMER UNTIL RELEASED.
COM O-OBS	MONITORED OPEN OBSTRUCTION INPUT	CONNECT TO 10K TERMINATED DEVICES (GATE EDGE, PHOTO BEAM) TO DETECT AN OBSTRUCTION DURING OPENING. WHILE GATE IS MOVING, ANY OPEN OBSTRUCTION SIGNAL WILL CAUSE THE GATE TO STOP, REVERSE A SHORT DISTANCE, AND THEN STOP AGAIN. AT THIS TIME THE AUTO CLOSE TIMER IS DISABLED, AND A RENEWED INPUT WILL BE REQUIRED TO START THE GATE AGAIN. SHOULD THE GATE BE RESTARTED AND THE OBSTACLE SIGNAL OCCUR AGAIN PRIOR TO REACHING A LIMIT, THE GATE WILL STOP AGAIN, LOCKOUT, AND SOUND THE CONTINUOUS TONE ALARM.
C-OBS COM	MONITORED CLOSE OBSTRUCTION INPUT	CONNECT TO 10K TERMINATED DEVICES (GATE EDGE, PHOTO BEAM) TO DETECT AN OBSTRUCTION DURING CLOSING. WHILE GATE IS MOVING, ANY CLOSE OBSTRUCTION SIGNAL WILL CAUSE THE GATE TO STOP, THEN REVERSE AND TRAVEL TO THE FULL OPEN POSITION. SHOULD A OPEN OBSTRUCTION INPUT OR AN OPEN DIRECTION INHERENT ENTRAPMENT CONDITION OCCUR PRIOR TO THE GATE REACHING THE OPEN LIMIT, THE OPERATOR WILL LOCKOUT AND SOUND THE CONTINUOUS TONE ALARM. IF THE AUTO CLOSE TIMER IS SET, WHEN THE CLOSE OBSTRUCTION INPUT IS CLEARED, THE GATE WILL CLOSE WHEN THE AUTO CLOSE TIMER EXPIRES.
COM REV	REVERSE	CONNECT TO NORMALLY OPEN DEVICES TO CAUSE A REVERSAL WHEN THE GATE IS TRAVELING CLOSED. THE GATE WILL REVERSE TO THE FULL OPEN POSITION.
OPEN LOOP OPEN LOOP	OPEN LOOP	CONNECT TO OPEN LOOP/FREE EXIT LOOP. THE GATE WILL OPEN WHEN THE LOOP IS TRIGGERED, AND REMAIN OPEN AS LONG AS THE LOOP IS TRIGGERED. REQUIRES LOOP DETECTOR.
REVERSE LOOP REVERSE LOOP	REVERSE LOOP	CONNECT TO REVERSE LOOP. TRIGGERING THE LOOP WILL CAUSE A REVERSAL WHEN THE GATE IS TRAVELING CLOSED. THE GATE WILL REVERSE TO THE FULL OPEN POSITION. REQUIRES LOOP DETECTOR.
SHADOW/RESET LOOP SHADOW/RESET LOOP	SHADOW/RESET LOOP	CONNECT TO SHADOW/RESET LOOP TO KEEP THE GATE IN ITS FULLY OPEN POSITION AS LONG AS THE SIGNAL IS PRESENT. USED TO KEEP GATE OPEN WHILE VEHICLE IS PASSING THROUGH. REQUIRES LOOP DETECTOR.
- +	ALARM	FACTORY CONNECTED TO THE ALARM BEEPER.
N.O. COM N.C.	AUX RELAY	FACTORY CONNECTED TO THE OPERATOR INTERNAL HOLDING BRAKE. MUST BE SET TO "STROBE" TO RELEASE BRAKE WHEN MOTOR IS RUNNING.
+ -	24 VOLT SOLAR PANEL	FOR CONNECTION TO 24 VOLT SOLAR PANEL FOR BATTERY CHARGING.
+ -	24 VOLT BATTERY	FACTORY CONNECTED TO BATTERIES IN DC MODEL OPERATORS.

Operator Accessory Connections

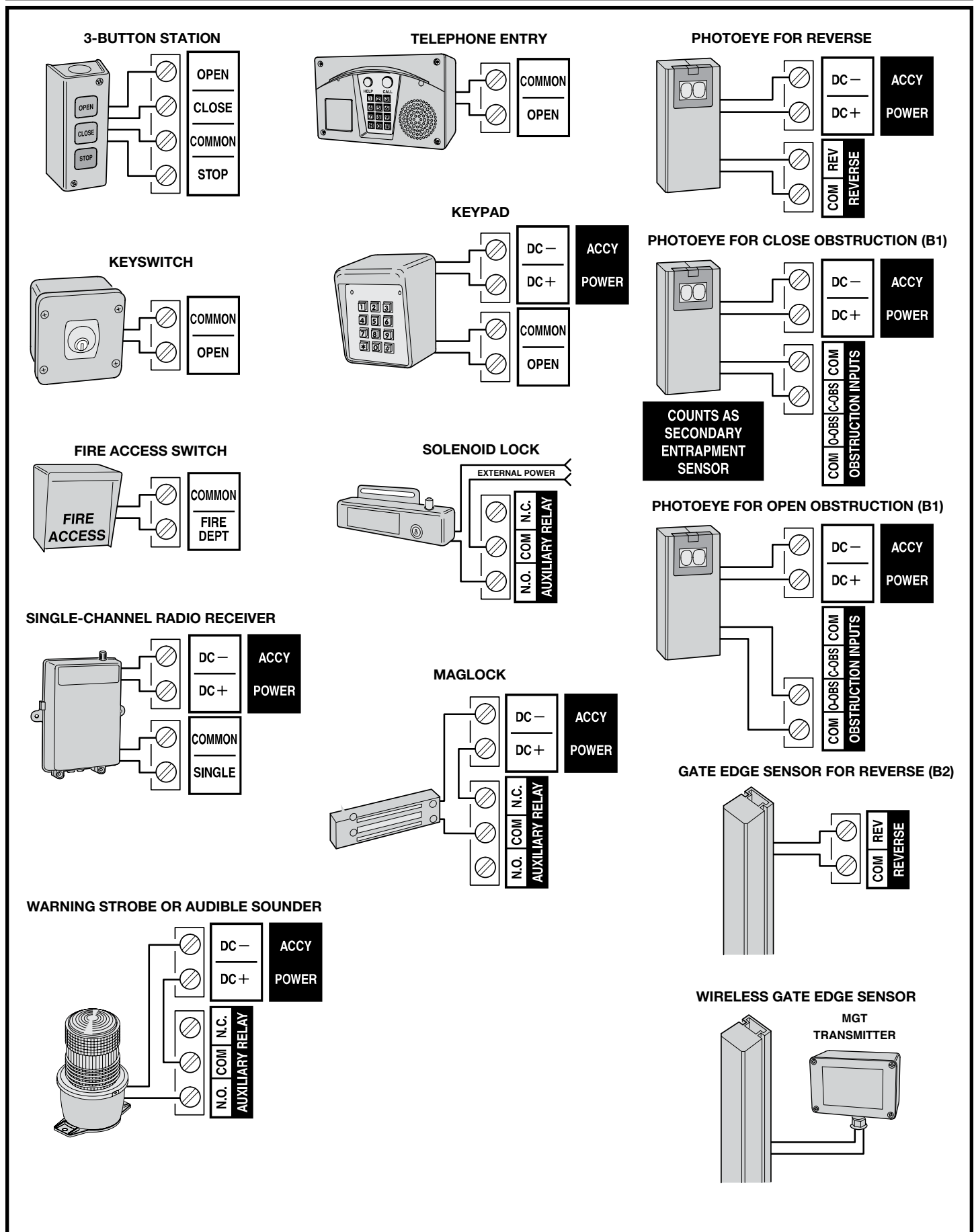

Figure 11. Operator Accessory Connections

Basic Controller Programming

Programming Overview

The Controller can be programmed with various options for the operator. The programming fields are defined as “functions” that have “options”. To make setup easier for the installer, the Controller’s programming is divided into two groups: basic and advanced. The basic programming group contains the functions commonly used in most slide gate installations. The advanced programming group contains functions less commonly used (i.e. dual gate stagger delay, maximum run timer, etc.).

Entering Programming Mode

Enter programming mode by pressing the **UP** and **DOWN** buttons together for one second. While in programming mode the **PROGRAM** indicator will light.

Exiting Programming Mode

Exit programming mode at any time by pressing the **UP** and **DOWN** buttons together. The Controller will automatically exit programming mode after three minutes of inactivity.

Programming Keystrokes

(Typical Programming Method)

While in programming mode, press the **UP** or **DOWN** buttons to scroll through the programming functions. When the desired function is displayed press the **ENTER** button to display the currently set option for the function. **When an option is displayed, the decimal points are lit.**

To change the option, press and hold the **ENTER** button for 1 second. To indicate that an option is ready to be changed, the display will flash. While the display is flashing, press the **UP** or **DOWN** button to display the other options available for that function.

When the desired option is displayed, press the **ENTER** button to store it into memory. To select another function, press **ENTER, UP,** or **DOWN.**

Left or Right Hand Operation

The factory default is for right hand operation (operator on right side of the driveway when viewed from the inside of the gate). For left hand installations, program the Controller for left hand operation.

Dual Gate Enable

The factory default is for single gate operation. For dual gate operation, wire the two gate controllers together through the **COMM LINK** terminals (see Page 25) and enable dual gate operation with this programming step.

✓ **NOTE:** The Mid-travel Stop feature is disabled when dual gate operation is enabled for paired units.

Auto Close Timer

The factory default turns off the Auto Close Timer. The timer can be set from 1 to 59 seconds and from 1 to 9 minutes. When the Auto Close Timer is set, after opening, the gate will wait for the length of the Auto Close Timer then close automatically.

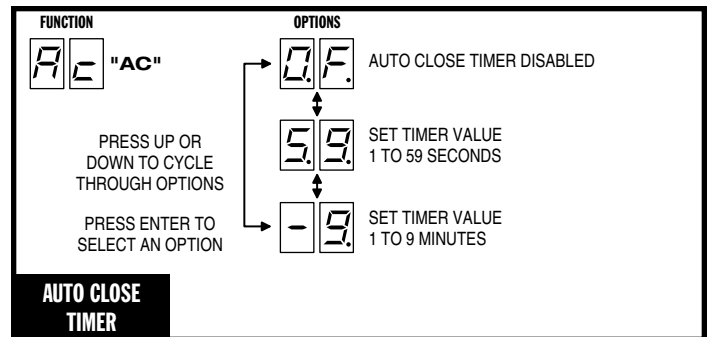
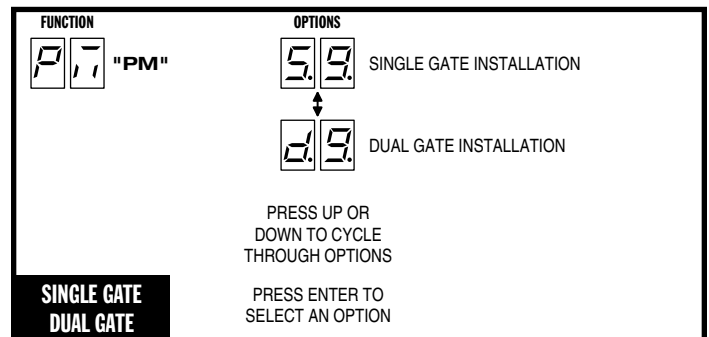
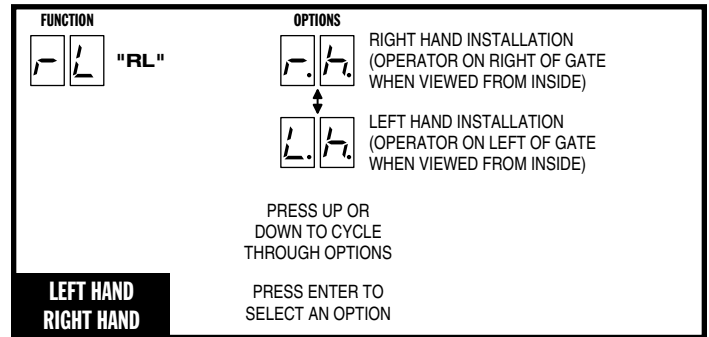
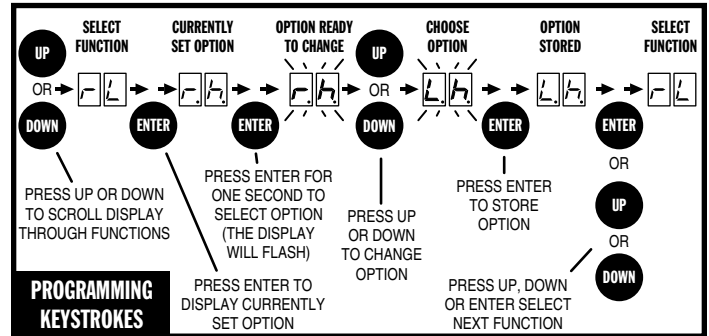
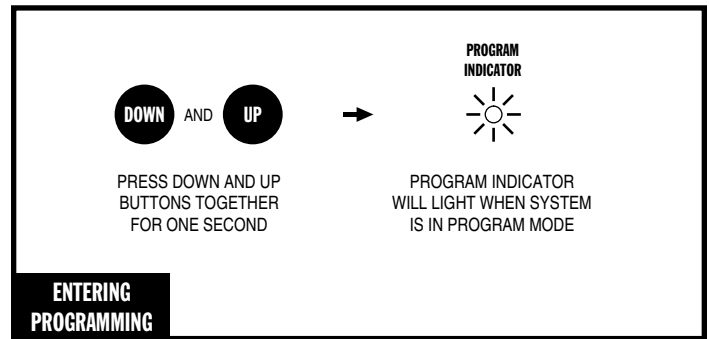

Basic Controller Programming (Cont.)

Run Alarm and Pre-start Alarm

The factory default is Run Alarm on and a 3-second Pre-start Alarm. The operator's beeper will sound 3 seconds before the operator starts. The options are:

- Run Alarm Off and Pre-start Alarm Off
- Run Alarm On and Pre-start Alarm Off
- Run Alarm On and Pre-start Alarm On for 1-9 Seconds

Maximum Open Direction Current Setting

To detect obstacles or mechanical problems with the gate, the operator monitors its motor current. If the open current load exceeds the programmed maximum load range number, the operator will stop, reverse a short distance, then stop again. The Auto Close Timer will be disabled, and another open request will be required to start the operator again. If after restart, the overload or an open obstacle happens again before the open limit is reached, the operator will lockout and sound the alarm.

To measure the motor load used during opening, **while this function is being displayed**, push and hold the **OPEN** button to fully open the gate. During movement, the motor current will be displayed as a load number from 0 to 99. This number is useful for troubleshooting but not for setting the motor current. At the end of travel, a different number will flash. This number indicates the range above and below the average motor current during the run. Using the + and - buttons, set the programmed range number so that a minimal force (50-75 lbs.) will activate a reversal should an obstruction occur, but high enough to keep the gate moving under normal conditions without interruption.

Maximum Close Direction Current Setting

To detect obstacles or mechanical problems with the gate, the operator monitors its motor current. If the close current load exceeds the programmed maximum load range number, the operator will stop, reverse, and travel to the full open position. Should an open obstruction input or an open direction inherent entrapment condition occur prior to the gate reaching the open limit, the operator will lockout and sound the continuous tone alarm. Another close request will be required to start the operator again. If after restart, the overload or a close obstacle happens again before the close limit is reached, the operator will lockout and sound the alarm. If the auto close timer is set, when the close obstruction input is cleared, the gate will close when the auto close timer expires.

To measure the motor load used during closing, **while this function is being displayed**, push and hold the **CLOSE** button to close the gate. During movement, the motor current will be displayed as a load number from 0 to 99. This number is useful for troubleshooting but not used for setting the motor current. At the end of travel, a different number will flash. This number indicates the range above and below the average motor current during the run. Using the + and - buttons, set the programmed range number so that a minimal force (50-75 lbs.) will activate a reversal should an obstruction occur, but high enough to keep the gate moving under normal conditions without interruption.

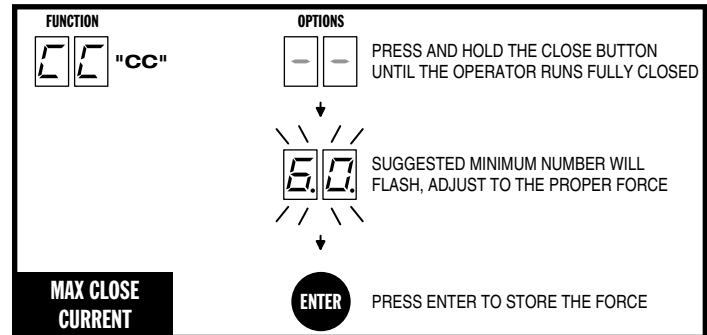
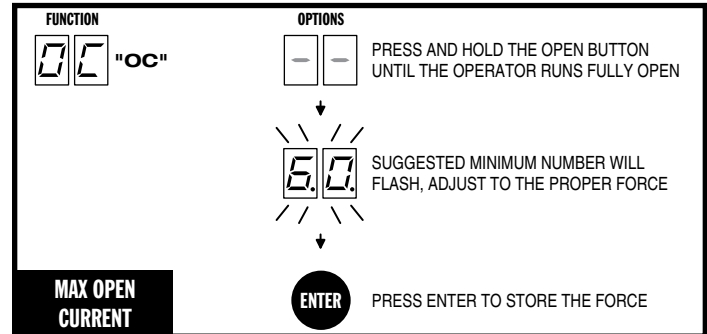
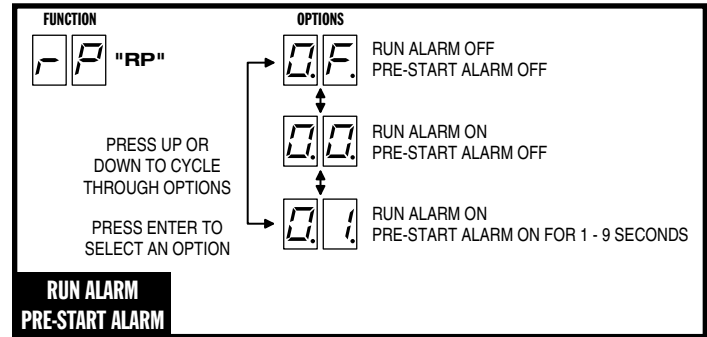

Obstruction detection type – b1, b2

B1 is a non-contact sensor such as a photo eye. B2 is a contact sensor such as an edge. This setting affects behavior in the closed direction obstruction detection. If a B2 detector is used, the operator will only allow an input 2 times to continue automatic closing until a closed limit switch is successfully made. The first input while closing will reverse the operator to full open and resume auto close timer behavior if selected. The second input will cause the operator to reverse slightly and lockout.

✓ **NOTE:** Jumper wire must be cut and DIP switches set to position 5 for the functions below to be active.

Open Obstruction input active – On, Off

If a swing gate has no entrapment areas this may be selected as off. This must be on for slide gates.

Close obstruction input active – On, Off

Single gates require this to be on. Paired gates can have this off if the other gate has it turned on.

✓ **NOTE:** The following parameters will only be displayed if Paired Mode is selected ON. The operators must be both set as paired mode, powered up, and have the communication cable in place to complete this correctly. Obstruction inputs active selection for both operators must all be made from one side. Settings will be automatically transferred to the operator you are not in front of. Do not try to set individually

Remote open obstruction active – On, Off

This is used to select if the other operator has the Open Obstruction input active.

Remote Close obstruction active – On, Off

In paired mode it is only required to have 1 close device per pair of operators if the only entrapment zone is where the gates meet.

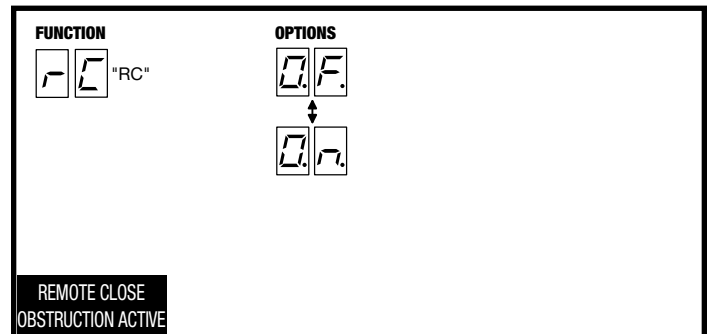
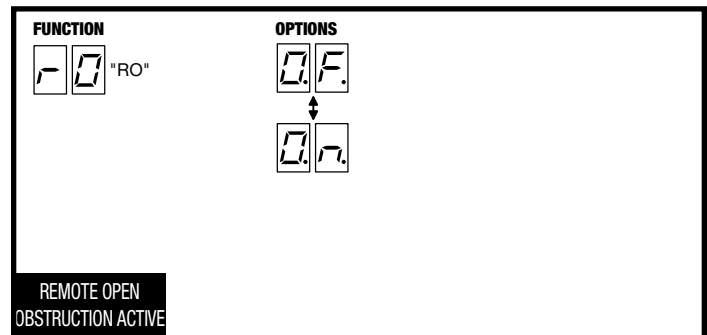
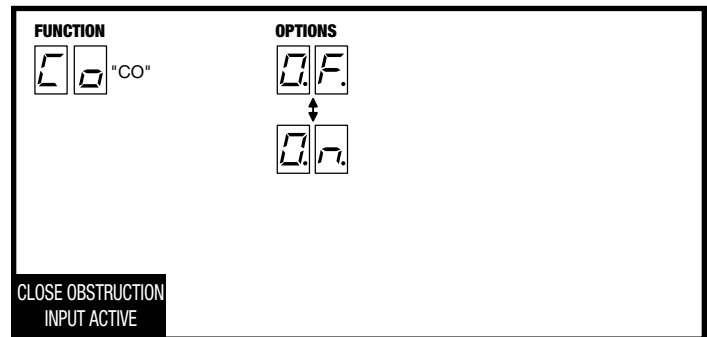
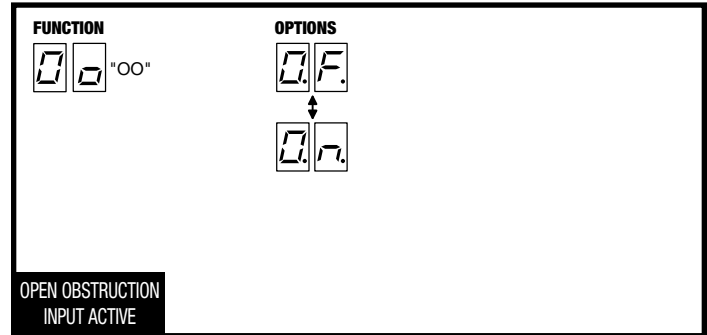
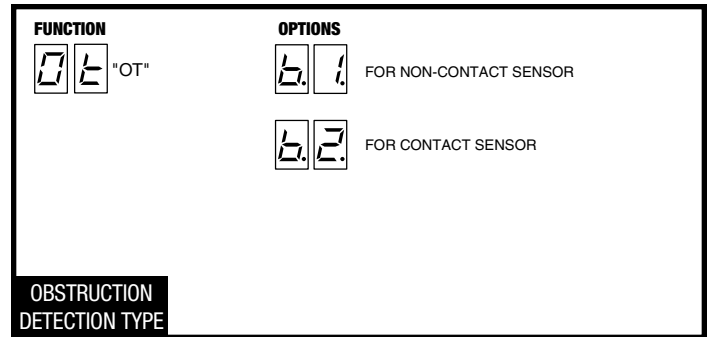

Advanced Controller Programming

Entering Advanced Programming Mode

To access and program the Advanced Programming functions, for each programming session, Advanced Programming must be enabled.

After exiting programming, the Advanced Programming functions will be available on the programming display during the next programming session unless the operator has run 50 or more cycles. After that, Advanced Programming must be enabled again.

Maximum Run Time

The factory default for the Maximum Run Time (MRT) is 99 seconds. When the operator starts, a timer will begin counting. If a open or close limit is not reached or an obstacle or reversing input is not received before the timer expires, the operator will stop, the unit locks out and the alarm sounds. The timer can be set for 10 to 99 seconds, but should be left at 99 in most applications. Setting it too close to the actual run time may cause the time to expire with changing ambient temperature, gate conditions, etc...

If AC is present and an open or close limit is not reached or an obstacle or reversing input is not received before this timer exceeds MRT, the operator will stop, the unit locks out and the alarm sounds.

In the case that AC is not present and MRT expires, it will be ignored as long as the actual run time is under 99 seconds. When the gate reached full open or full close position, MRT will be interpreted as fail safe/secure. EN05 will occur. If FS as set to fail safe, the gate will open. If FS is set to fail secure, the gate will close. However, if the actual run time is higher than 99, it will be interpreted as a physical mechanical problem, EN01 will occur and the gate will stop immediately.

Single Button Input Setup

This function is used for selecting the operation for single button controls and radio receivers.

The factory default sets the **SINGLE** input terminal so successive inputs will cycle the operator in OPEN-STOP-CLOSE-STOP order.

Alternately, the **SINGLE** input can be set to cause the gate to OPEN unless the gate is fully open. If the gate is fully open, the input will cause the gate to CLOSE.

Stagger Mode (Rarely used in slide gate installations)

This function is used in dual gate installations only. The factory default sets the Stagger Mode to OFF. In dual gate installations the two operators communicate through the 3-wire **COMM LINK** interface. When using the Stagger Mode, set one operator for delayed opening and the other operator for delayed closing. The Stagger Delay Time programming function (see below) sets the length of the delay.

✓ **NOTE:** This function will only be displayed if dual gate operation is selected.

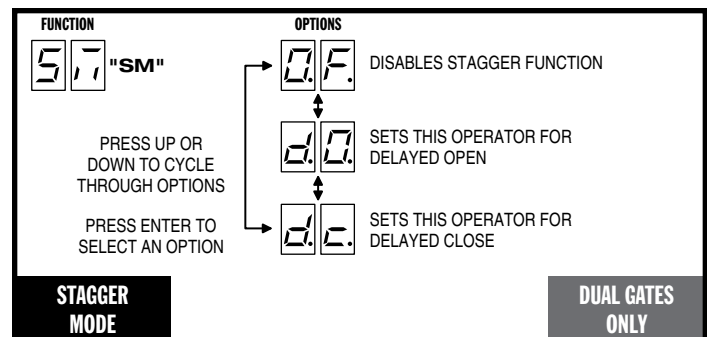
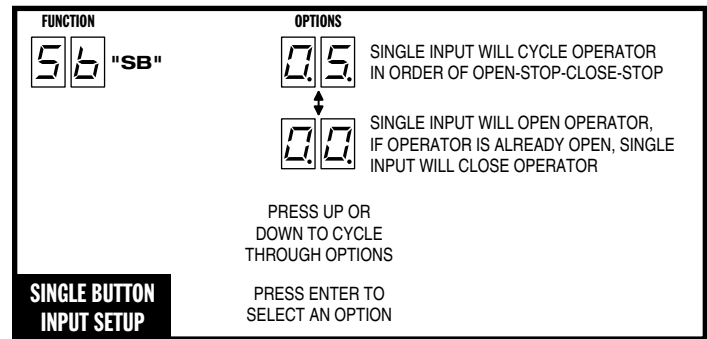
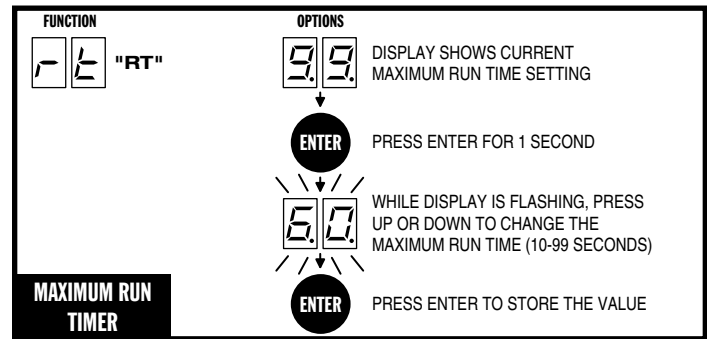
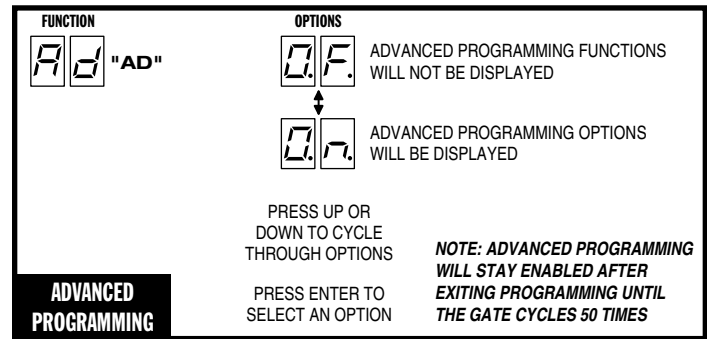

Advanced Controller Programming (Cont.)

Stagger Delay Time (Rarely used in slide gate installations)

This function is used in dual gate installations only. The factory default sets the Stagger Time to 0 seconds (OFF). The Stagger Time sets the delay for the Stagger Mode. The Stagger Time can be set from 1-99 seconds.

✓ **NOTE:** This function will only be displayed if dual gate operation is selected.

This should be left at 99 seconds in most instances. Setting it close to the actual run time may cause the timer to expire with changing temperature, gate conditions, etc...

Auxiliary Relay Mode

The Auxiliary Relay has normally open and normally closed contacts. The factory setting disables the Auxiliary Relay. The relay can be set for:

- **Maglock:** To deactivate a magnetic or solenoid gate lock, the relay will energize during any pending or actual gate motion (open only).
- **M4:** To deactivate a magnetic or solenoid gate lock, the relay will energize during any pending or actual gate motion (open only). 3 seconds after the gate starts to move, the relay will de-energize. This option is used for higher current solenoid locks.
- **Ticket Dispenser:** The relay will energize while the gate is moving in the open direction and at the full open limit, or in an entrapment condition.
- **Strobe:** **FACTORY SET TO RELEASE INTERNAL BRAKE. DO NOT CHANGE.**
- **Alarm:** The relay will energize if the gate is manually forced open from the full closed position.

Reverse Delay Time

The factory default sets the Reverse Delay to 1 second. The operator will wait the length of the delay before reversing direction. This feature will not change the reversal time when the operator is responding to an entrapment condition from an obstruction input or inherent entrapment protection sensor. The Reverse Delay can be set from 1 to 9 seconds. Heaver gates require a longer delay to allow time for the gate to stop.

Constant Pressure Mode

The factory default allows momentary pressure on a control station's **OPEN** or **CLOSE** button to cycle the operator. The controller can be set to require constant pressure on the **OPEN**, **CLOSE**, or both buttons to run the operator.

- ✓ **NOTE:** If a button is set for constant pressure, and it is released before the operator reaches the open or close limit, the operator will stop the gate at its current position.
- ✓ **NOTE:** If CP is set, monitored obstruction input is not required for selected direction of travel.

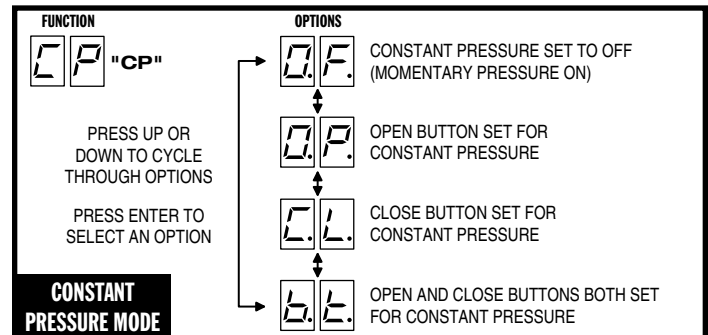
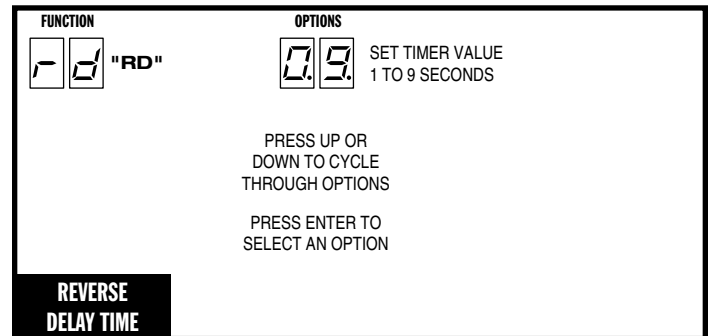
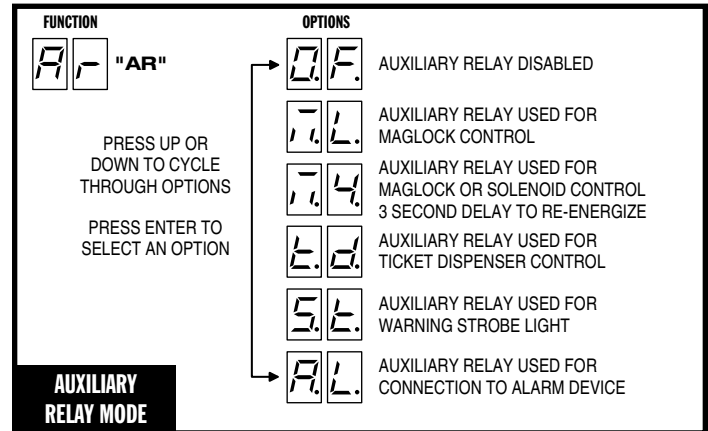
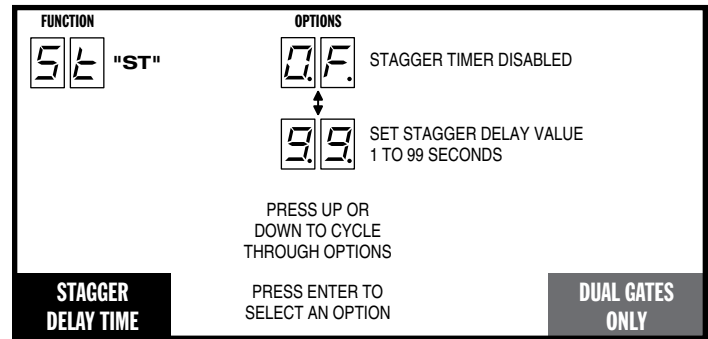

Advanced Controller Programming (Cont.)

Shadow Loop Open Prevention

If the shadow loop is triggered, it always prevents the gate from *closing* if the Auto Close Timer activates or a CLOSE command is given while the gate is at the full open position.

The controller can also be set to prevent the gate from *opening* if the shadow loop is triggered while the gate is at the close limit position. This prevents a swing gate from opening into a vehicle if it's parked near the gate on the inside.

Low Power Mode

The factory default disables the Low Power Mode. When Low Power Mode is enabled, and AC power fails, the controller will assume Low Power Mode after 60 seconds of gate inactivity. Low power mode turns off all accessory power and indicators. Only inputs from the radio receiver, reverse loop, open loop (optional by programming), fire department input, or restoring AC power will wake the Controller from Low Power Mode. Programming Mode can still be accessed while the Controller is awake in Low Power Mode.

Power Failure Mode

The factory default is set for Fail Safe, alternately the Controller can be set for Fail Secure, Open Immediate, or Close Immediate.

- **Fail Safe:** If the AC power fails and the battery voltage drops below approximately 22 Volts, 5 seconds later the operator will cycle open if not already open. When AC power is restored, or the battery gets charged by solar panels, the operator will resume normal operation and auto-close if programmed to do so.
 - **Fail Secure:** If the AC power fails and the battery voltage drops below approximately 22 Volts, 5 seconds later the operator will cycle closed if not already closed. When AC power is restored, or the battery gets charged by solar panels, the operator will resume normal operation.
- ✓ **NOTE:** Fail Safe and Fail Secure are disabled if Stagger Mode is enabled.
- **Open Immediate:** If the AC power fails, the operator will cycle open if not already open and cease operation. When AC power is restored, the operator will resume normal operation and auto-close if programmed to do so.
 - **Close Immediate:** If the AC power fails, the operator will cycle closed if not already closed and cease operation. When AC power is restored, the operator will resume normal operation.

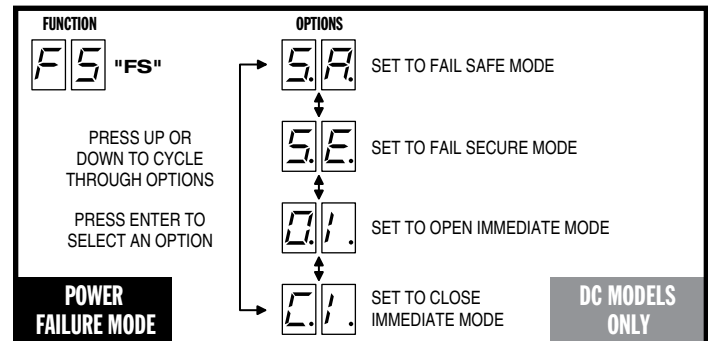
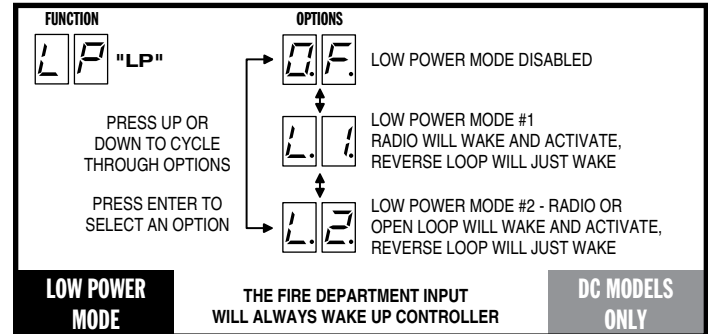
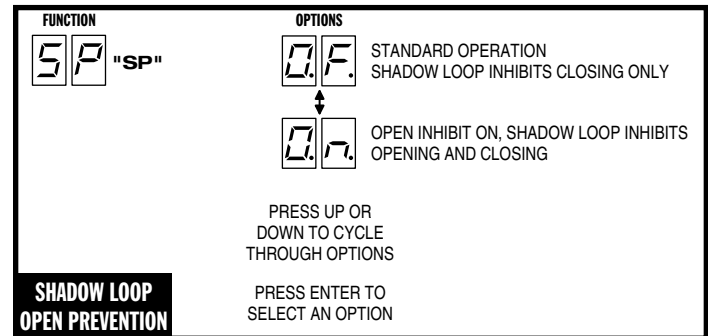

Advanced Controller Programming (Cont.)

Soft Start/Stop Duration

This function causes the operator to start and stop the DC motor slowly reducing gate wear and tear (at the full open or closed positions only). The factory default sets the Soft Start/Stop Duration to 3 seconds. The Soft Start/Stop Duration can be set from 1 to 10 seconds.

✓ **NOTE:** Changing the Soft Start/Stop Duration will reset the open and close current setting value to zero. It will be necessary to reprogram maximum open and close current settings.

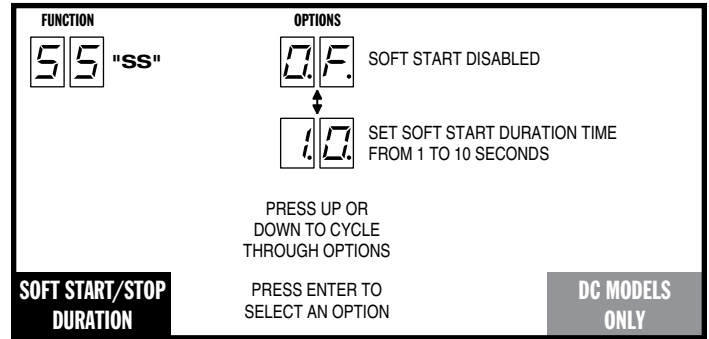

Reset Cycle Count

The Controller counts of the number of times the operator has been cycled full open and close. The cycle count can be displayed. The display will scroll the cycle count number, flashing two digits at a time from left to right.

To reset the Cycle Count, press and hold the **ENTER** button for 2 seconds while the Cycle Count is displayed.

If the Maintenance Alert has been triggered, resetting the Cycle Count will also reset the Maintenance Alert indicator.

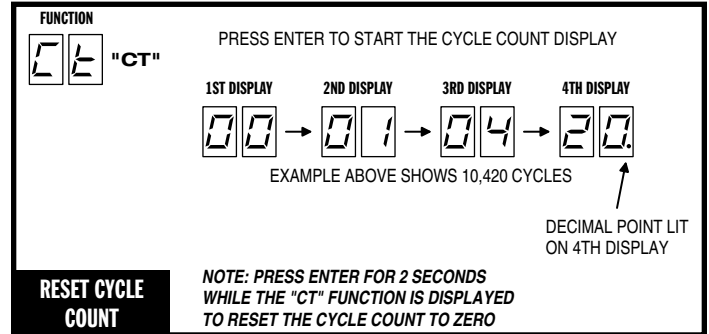

Maintenance Alert Trigger

The Controller has a **MAINT ALERT** indicator that can be programmed to light when the number of activations exceeds a set number of cycles.

The factory default sets the Maintenance Alert Trigger to 10,000 cycles. The Maintenance Alert Trigger can be programmed for 5, 10, 15, or 25 thousand cycles.

The Maintenance Cycle Count can be reset independently from the operator's absolute Cycle Count.

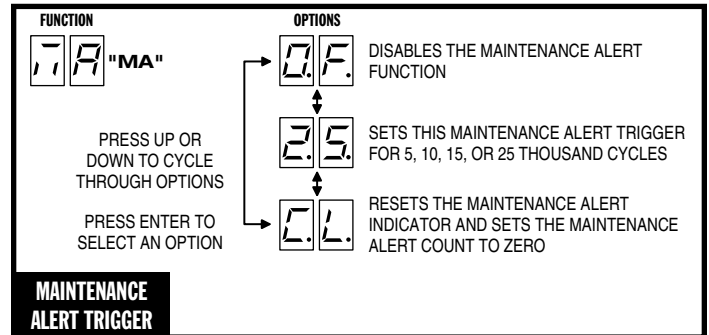

Advanced Controller Programming (Cont.)

Mid-travel Stop Position

The Controller can be programmed so the gate will stop at a mid-travel point instead of fully opening. This can be useful in installations where a large gate, that takes a long time to open and close fully, only needs to be opened partway to allow traffic to pass.

The factory default sets the Controller for full open operation. Alternately, the Controller can be programmed to open for 1 to 99 seconds then stop, before reaching the open limit.

When a Mid-travel Stop Position time has been programmed, the gate will **still fully open** if the Fire Department input is triggered, if the **OPEN** button is held down beyond the Mid-travel Stop Position, or a close obstruction or reverse loop input is triggered.

✓ **NOTE:** The Mid-travel Stop feature is disabled when dual gate operation is enabled for paired units.

Anti-tailgate Enable

The factory default sets the Anti-tailgate Enable to OFF. With this setting, during a gate cycle, after the shadow loop has been triggered by the vehicle and then has cleared after the vehicle passes, the Auto Close Timer or a CLOSE command is required to begin closing the gate.

If the Anti-tailgate Enable is set to ON, the gate will close immediately as soon as the shadow loop has cleared. Any subsequent shadow loop triggers while the gate is closing will stop the gate. When the shadow loop clears, the gate will continue closing.

Motor Type Selection

The factory sets the default for the Controller to match the type of motor in the operator. **THE MOTOR TYPE SHOULD BE "d2".**

- AC Motor Only
- DC Motor Only with Mechanical Braking
- DC Motor with Electronic Soft Start/Stop
- 3 Phase AC Motor
- AC Motor with DC Motor Backup with Mechanical Braking
- AC Motor with DC Motor Backup with Electronic Soft Start/Stop

FUNCTION	OPTIONS
"MT"	MID-TRAVEL STOP DISABLED (GATE RUNS FULL TRAVEL)
	↕
	SET LENGTH OF OPENING TIME FROM 1 TO 99 SECONDS
	PRESS UP OR DOWN TO CYCLE THROUGH OPTIONS
	PRESS ENTER TO SELECT AN OPTION

MID-TRAVEL STOP POSITION

FUNCTION	OPTIONS
"AT"	ANTI-TAILGATE ENABLE OFF GATE REQUIRES AUTO OR MANUAL CLOSE
	↕
	ANTI-TAILGATE ENABLE ON GATE CLOSES WHEN SHADOW LOOP CLEARS
	PRESS UP OR DOWN TO CYCLE THROUGH OPTIONS
	PRESS ENTER TO SELECT AN OPTION

ANTI-TAILGATE ENABLE

FUNCTION	OPTIONS
"MO"	AC MOTOR ONLY
	DC MOTOR ONLY WITH BRAKING
	DC MOTOR WITH SOFT START/STOP
	3 PHASE AC MOTOR
	AC MOTOR PRIMARY WITH DC MOTOR BACKUP WITH BRAKING
	AC MOTOR PRIMARY WITH DC MOTOR BACKUP WITH SOFT START/STOP

PRESS UP OR DOWN TO CYCLE THROUGH OPTIONS

PRESS ENTER TO SELECT AN OPTION

NOTE: SELECTION MUST MATCH MOTOR BOARD!

MOTOR TYPE SELECTION

Advanced Controller Programming (Cont.)

Radio Enable

The Controller contains a built-in MegaCode® radio receiver to allow activation from up to 40 access control transmitters and two Model MGT (gate edge) transmitters. The factory default enables the internal radio receiver. Alternately, the internal receiver can be disabled.

Antenna Installation

The Controller is supplied with a local whip antenna installed. If using a remote antenna, remove the whip antenna and connect coax cable from the antenna to the **ANTENNA** connector.

Radio Transmitter Learn

The Controller's built-in MegaCode® radio receiver can store the IDs of up to 40 transmitters. Refer to the figure for the steps required to learn transmitters.

- ✓ **NOTE:** This function will NOT be displayed if the transmitter memory is full, or if the radio receiver is disabled.

Radio Transmitter Delete

Transmitters can be deleted from the Controller's memory either individually, or all at the same time. Refer to the figure for the steps required to delete transmitters.

- ✓ **NOTE:** This function will NOT be displayed if no transmitters are stored in memory, or if the radio receiver is disabled.

MGT Obstacle Transmitter Learn

The Controller supports one or two Model MGT Obstacle Transmitters. The transmitters can be programmed to function as Open Obstruction, Close Obstruction, Reverse, or Stop. Refer to the figure for the steps required to learn MGT transmitters.

- ✓ **NOTE:** This function will NOT be displayed if two MGT transmitters are already stored in memory, or if the radio receiver is disabled.

MGT Monitoring Function

ON monitor's battery and connection of MGT transmitter.

2 missed signals result in alarm beeping.

- ✓ **NOTE:** Not used for UL 325 6th edition monitored input.

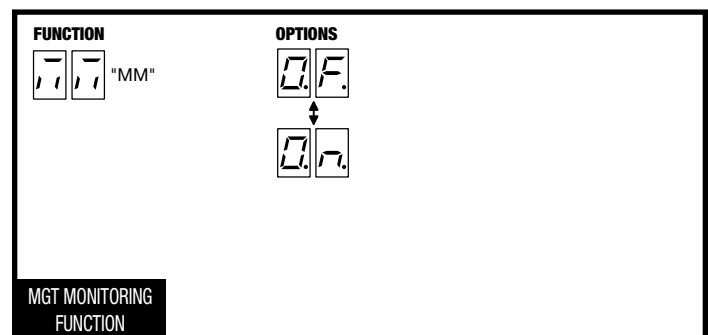
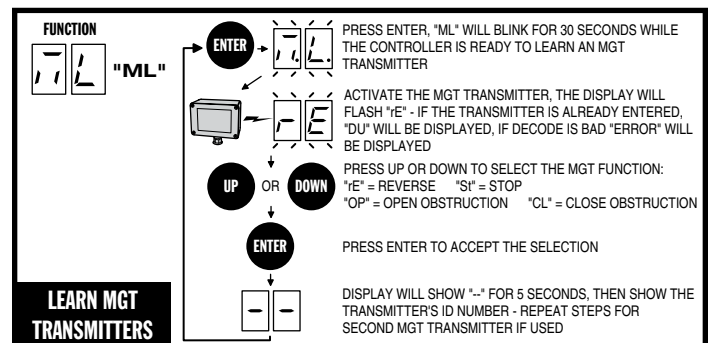
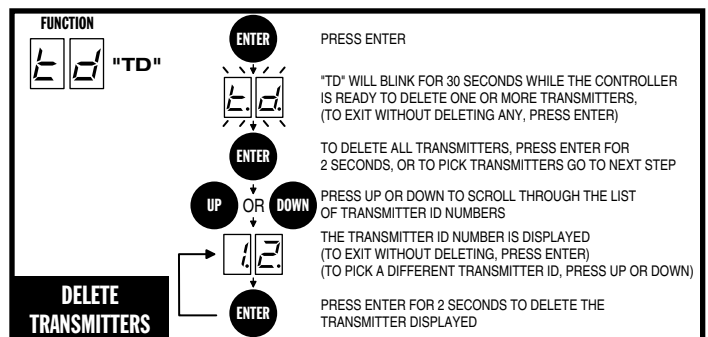
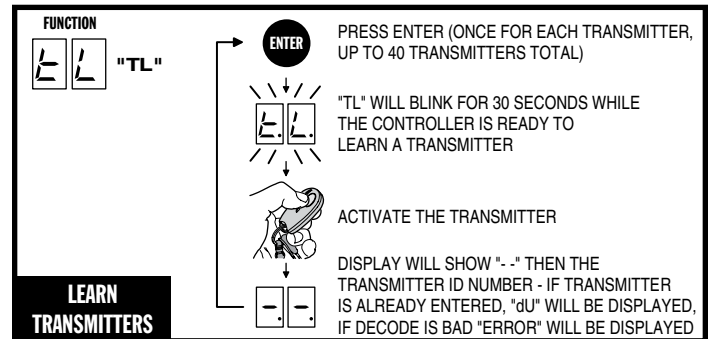
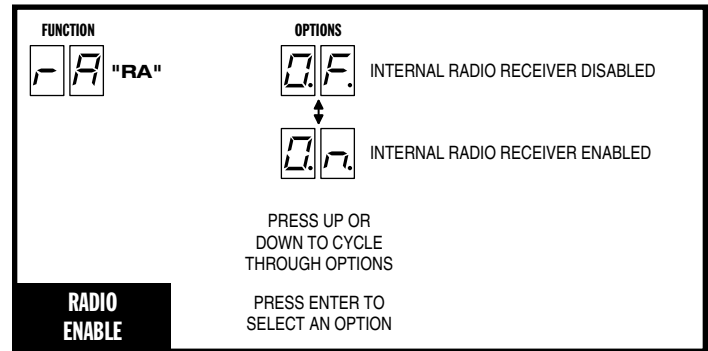

MGT Obstacle Transmitter Delete

MGT transmitters can be deleted from the Controller's memory either individually, or all at the same time. Refer to the figure for the steps required to delete MGT transmitters.

✓ **NOTE:** This function will NOT be displayed if no MGT transmitters are stored in memory, or if the radio receiver is disabled.

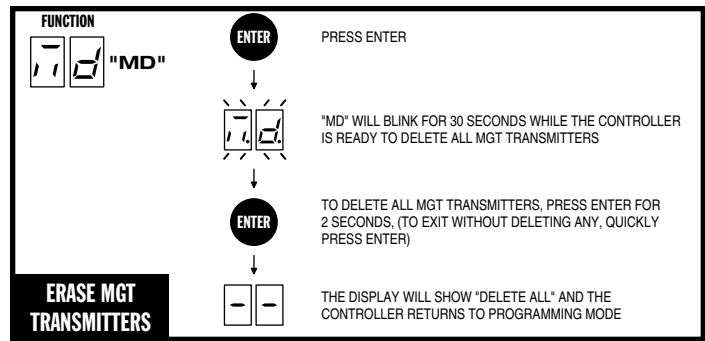

Reset Controller to Factory Defaults

The Controller can be reset with this function. **ALL PROGRAMMED DATA WILL BE LOST**, and the factory defaults will be loaded. This function will not erase radio transmitters, current sense values, or motor type. Transmitters must be deleted with the two functions above.

DO NOT USE THIS FEATURE UNLESS INSTRUCTED TO DO SO BY ROTARY GATE SYSTEMS TECH SUPPORT.

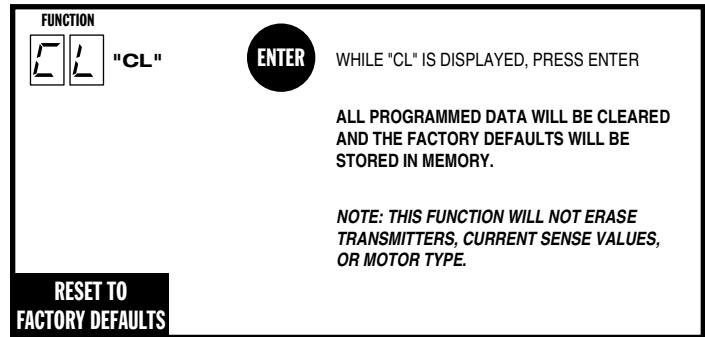

Minimum settings for programming. If an "illegal" setting is chosen, the operator will flash EN 15 upon exiting programming and self-adjust settings to the minimums below.

✓ **NOTE:** Jumper wire must be cut for Settings 1-5.

Maximum Settings By Gate Type	Monitoring Required			
	Single (Gate 1) Host		Paired (Gate 2)	
DIP Switch Setting	OPEN	CLOSE	OPEN	CLOSE
0 – Swing/Slide	Yes	Yes	Yes	No
1 – Standard Barrier	No	No	No	No
2 – Slow Barrier	No	No	No	No
3 – Variable Barrier	Yes	Yes	Yes	No
4 – Not Used	Yes	Yes	Yes	No
5 – Swing Override	No	Yes	No	No

Dual Gate Installations

Two operators can be used in dual gate installations. The operators communicate with each other through the 3-wire **COMM LINK** terminals.

When one operator activates, the **COMM LINK** connection signals the other operator to activate. Each operator functions independently, controlling its gate and monitoring its inputs and accessories.

A three-wire shielded conductor cable is required to connect two operators together for dual operation. Use Belden 8760 Twisted Pair Shielded Cable (or equivalent) only – P/N 2500-1982, per foot).

✓ **NOTE:** The shield wire should be connected **COMM LINK** terminal "C" in both operators.

Three of the programming functions available are only used for dual gate installations:

- **Dual Gate Enable**
Dual Gate Enable must be set for all dual gate installations.
- **Stagger Mode**
The Stagger Mode function determines if the operator has a delayed open or a delayed close. In dual swing gate installations, typically one operator is programmed for delayed open, and the other operator is programmed for delayed close.
- **Stagger Delay Time**
The Stagger Time sets the length of the delay for the Stagger Mode.

Set the following parameters in each gate operator individually in a single gate mode before connecting the network cable and operating in dual gate mode.

1. Open and Close Limit settings
2. Open and Closed direction inherent entrapment protection (OC & CC)

After these parameters have been set, and each operator has been tested independently and is functioning correctly in single gate mode, then set BOTH operators to dual gate (dg) in the Paired Mode setup step under Basic Programming steps.

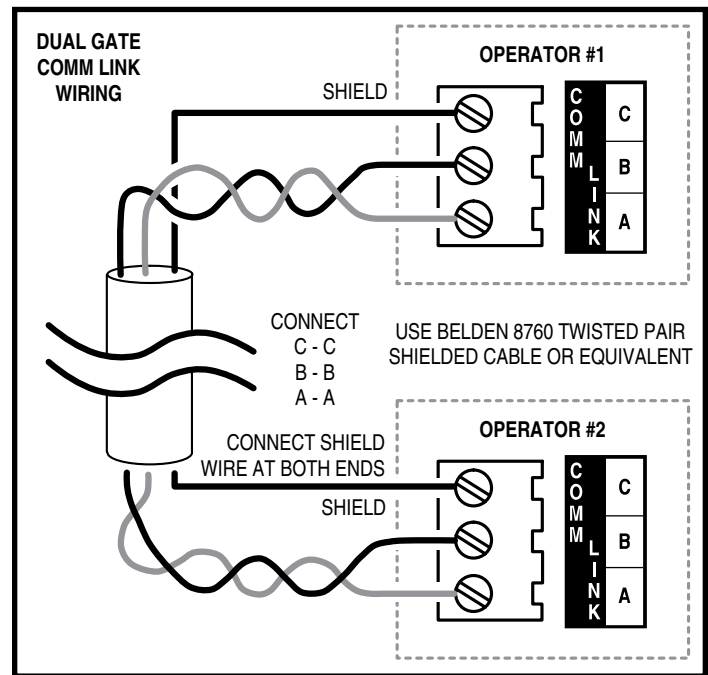

Figure 12. COMM LINK Wiring

Gate Operation

Open Button

Opens the gate. If the Controller is programmed to stop opening the gate at mid-travel, a constant press of the **OPEN** button will override the Mid-travel Stop and completely open the gate. If the Auto Close Timer is set, it will be suspended until the **OPEN** button is released.

Close Button

Closes the gate if the gate is open. Also closes the gate if the gate is in the process of opening.

Stop Button

Stops the gate from opening or closing at any time.

Single Input

Opens the gate if it's closed and closes the gate if it's open (open-close programming option). Activating the input while the gate is moving will reverse the gate.

Can be programmed to stop the gate while the gate is moving (open-stop-close programming option).

Fire Department Input

Fully opens the gate when the input is activated. Overrides the Mid-travel Stop and Auto Close Timer (if either is programmed for the gate). The gate will lockout in the open position without sounding the alarm. Press the **STOP** button to release the lockout.

Open Input

Functions the same as the **OPEN** button.

Open Obstruction

While the gate is opening, any open obstruction signal will cause the gate to stop, reverse a short distance, and then stop again. The Auto Close Timer will be disabled, and a renewed input will be required to start the gate again. Should the gate be restarted and the obstacle signal occur again prior to reaching a limit, the gate will stop again, lockout, and sound the emergency alarm.

Close Obstruction

While the gate is closing, any close obstruction signal will cause the gate to stop, reverse, and travel to the full open position. Should a open obstruction input or an open direction inherent entrapment condition occur prior to the gate reaching the open limit, the operator will lockout and sound the continuous tone alarm. Another close request will be required to start the operator again. If after restart, the overload or a close obstacle happens again before the close limit is reached, the operator will lockout and sound the alarm. If the auto close timer is set, when the close obstruction input is cleared, the gate will close when the auto close timer expires.

Reverse Input

If the reverse input is triggered while the gate is closing, the gate will reverse to the full open position. If the Auto Close Timer is set, when the reverse input is cleared, the gate will close when the Auto Close Timer expires.

Open Loop

Functions the same as the **OPEN** button.

Reverse Loop

Functions the same as the reverse input.

Shadow/reset Loop

Only used with Swing Gates. Holds the gate fully open or fully closed while triggered. If open, the gate closes immediately when cleared if Anti-tailgate is enabled.

Operation Indications

During normal operation, the Controller's displays will indicate current operating conditions and status.

Power-up Display

When the Controller powers up, dashes will show on the display, then the firmware version number, then the gate type (SL for slide and swing gates).

Exiting programming restarts the Controller. The power-up display will show upon the restart.

Idle Condition

While the Controller is idling, waiting for a command, the display will show circulating dashes.

For DC models only - Clockwise : Batteries discharging,
Counterclockwise : Batteries charging.

Last Gate Position/Condition

When the gate moves or stops, the display will show the status for up to one minute.

- Stop is displayed as **St**
- Full Close is displayed as **FC**
- Full Open is displayed as **FO**
- Entrapment is displayed as **En**

Pre-start Delay

During the pre-start delay, the display will countdown the number of seconds remaining before the operator starts.

Reverse Delay

If the gate travel direction is reversed from a user activation or reversing device, and a reverse delay is set, the display will count down the delay time in seconds before the operator restarts.

Run Timer

While the gate is opening or closing, the number of seconds running time is displayed.

Error Indications

During abnormal operation, the Controller's displays and beeper will indicate the error condition that has occurred.

Entrapment

If an entrapment condition occurs detected by two repeated open or close obstruction triggers, the Controller will lock the operator out. The beeper will sound constantly and the gate will not operate. To reset the Controller press the **STOP** button or press the **RESET** button on the operator's cover.

 WARNING 
<p>The Stop and/or Reset button must be located in the line-of-sight of the gate. Activation of the reset control shall not cause the operator to start.</p>

COMM LINK Connection Failure

In dual gate installations, if there is a connection failure between the two operators, the **COMM LINK** indicator will blink once a second. During this condition the gate will not operate, except if triggered by the **FIRE DEPT** input, which functions normally.

MGT Obstacle Transmitter Trouble

If any MGT transmitters are used with the operator, their supervision feature will alert the Controller if there is any trouble with the transmitter. MGT transmitters send hourly status reports and will send low battery reports when the transmitter has a low battery. The MGT transmitters also have a tamper detection switch that will trigger when their case is opened.

When the Controller detects a low transmitter battery, a tamper signal, or missing transmitter status reports, the gate will still operate normally, but the beeper will change as follows:

- The Pre-start Alarm will beep twice as fast.
- The Run Alarm will beep twice as fast and continue for five minutes after the gate stops.
- The sounder will "chirp" every five seconds when the gate is idle.

Correct the trouble (close case, replace battery, or replace transmitter) to clear the obstacle transmitter trouble indications.

Maximum Run Time Exceeded

If the Maximum Run Time is exceeded, the Controller stops the operator the same as if a double obstacle has occurred in an entrapment condition. The entrapment alarm sounds constantly, and is cleared by pressing the **STOP** button or the **RESET** button on the cover. After the **STOP** or **RESET** button is pressed, because the Maximum Run Time has been exceeded, the sounder will beep twice every five seconds. The next operation of the gate will clear the indication.

CONTROLLER ERROR CAUSES AND INDICATIONS		
ERROR CAUSE	ERROR INDICATION	HOW TO CLEAR
TWO SAFETY REVERSALS (ON SINGLE GATE OR ON EITHER DUAL GATE)	En 00, CONTINUOUS ALARM BEEPER, GATE DISABLED	PRESS STOP BUTTON
MAXIMUM RUN TIMER EXCEEDED ON OPENING	En 01, AND MAX RUN LED, CONTINUOUS ALARM BEEPER, GATE DISABLED	PRESS STOP BUTTON, CLEARS CONTINUOUS ALARM, THEN DOUBLE BEEP EVERY 5 SECONDS UNTIL NEXT OPERATION
MAXIMUM RUN TIMER EXCEEDED ON CLOSING	En 02, AND MAX RUN LED, CONTINUOUS ALARM BEEPER, GATE DISABLED	PRESS STOP BUTTON, CLEARS CONTINUOUS ALARM, THEN DOUBLE BEEP EVERY 5 SECONDS UNTIL NEXT OPERATION
COMM LINK FAILURE	En 03, AND COMM LINK LED, CONTINUOUS ALARM BEEPER FOR 1 MINUTE, GATE DISABLED (EXCEPT FOR FIRE DEPT INPUT)	PRESS STOP BUTTON, CLEARS CONTINUOUS ALARM
GATE FULL OPEN RESULTING FROM FIRE DEPT INPUT	En 04, GATE DISABLED	PRESS STOP BUTTON
FAIL SAFE OR FAIL SECURE BECAUSE OF BATTERY VOLTAGE DROP BELOW 21.6 VDC DUE TO AC POWER LOSS	En 05, GATE DISABLED	BATTERY VOLTAGE MUST RISE ABOVE 24 VDC
OTHER CONTROLLER IN ENTRAPMENT (DUAL GATE)	En 06, GATE DISABLED	CLEAR ENTRAPMENT ON OTHER CONTROLLER (PRESS STOP)
LOW AC VOLTAGE AT CONTROLLER	En 07, GATE DISABLED	RESTORE AC POWER TO NORMAL LEVEL
INPUT TRIGGERED DURING ENTRAPMENT LOCKOUT	En 08, GATE DISABLED	PRESS STOP BUTTON
COMPATIBILITY PROBLEM	En 09, GATE DISABLED	UPDATE FIRMWARE AND RESET BOTH PAIRED CONTROLLERS
EEPROM PROBLEM	En 10, GATE DISABLED	TRY RESET, CALL TECH. SUPPORT
DC MOTOR MISMATCH	En 11, GATE DISABLED	REPROGRAM MOTOR TYPE OR CHANGE DC MOTOR BOARD, NEXT GATE MOVEMENT WILL RETRY DC MOTOR CHECK
MOTOR FAILURE	En 12, GATE DISABLED	REPLACE MOTOR
AC POWER LOSS IN OPEN OR CLOSE IMMEDIATE POWER FAIL MODE	En 13	REAPPLY AC POWER
MAXIMUM RUN TIMER EXCEEDED AFTER AC POWER LOSS	En 14	BATTERY VOLTAGE MUST RISE ABOVE 24 VOLTS
MGT SUPERVISORY CONDITION (TAMPER, LOW BATTERY, MISSING HOURLY STATUS)	FAST BEEPS DURING PRESTART, FAST BEEP RUN ALARM, CHIRP EVERY 5 SECONDS AT IDLE	CLEARS WHEN MGT CONDITION CLEARS

Gate Operator Installation Checklist

INSTALLER CUSTOMER

- | | | |
|--------------------------|--------------------------|--|
| <input type="checkbox"/> | <input type="checkbox"/> | 1. The gate has been checked to make sure it is level and moves freely in both directions. |
| <input type="checkbox"/> | <input type="checkbox"/> | 2. Potential pinch areas have been guarded so as to be inaccessible OR have contact and/or non-contact obstruction sensing devices installed. |
| <input type="checkbox"/> | <input type="checkbox"/> | 3. The installer has installed one or more contact or non-contact obstruction sensing devices, in compliance with UL325 requirements for this installation. |
| <input type="checkbox"/> | <input type="checkbox"/> | 4. If pedestrian traffic is expected, a separate pedestrian gate has been installed, a minimum of seven feet from the gate. The customer has been informed that <u>all pedestrian traffic must use the pedestrian gate.</u> |
| <input type="checkbox"/> | <input type="checkbox"/> | 5. Warning signs have been installed on each side of the gate in highly visible locations. The customer has been informed that these signs must remain at all times. |
| <input type="checkbox"/> | <input type="checkbox"/> | 6. There are no controls installed on the gate operator, or within seven feet of the gate. |
| <input type="checkbox"/> | <input type="checkbox"/> | 7. The installer has properly adjusted the obstruction sensing feature and has tested the gate to make sure that the gate stops and reverses a short distance with minimal resistance applied (40 lbs. on a swing gate at the end of the gate, 75 lbs. on a slide gate) |
| <input type="checkbox"/> | <input type="checkbox"/> | 8. The installer has instructed the customer in the proper use of the gate operator and reviewed all of the operational functions, obstruction sensing devices, warning beeper and reset, etc. |
| <input type="checkbox"/> | <input type="checkbox"/> | 9. The installer has instructed the customer in the proper use of the operator's manual disconnect feature. The manual disconnect must never be used while the gate is in motion. The power switch must be turned off before using the manual disconnect and disengaging the operator. |
| <input type="checkbox"/> | <input type="checkbox"/> | 10. The installer has reviewed all safety instructions with the customer, and has left the safety instructions and owner's information sheets for their reference. |
| <input type="checkbox"/> | <input type="checkbox"/> | 11. The installer has answered any questions the customer has regarding the operation of the gate operator and gate operator safety precautions. |
| <input type="checkbox"/> | <input type="checkbox"/> | 12. The installer has explained to the customer that a regular maintenance schedule for both the gate and the gate operator is recommended. |

By signing this installation checklist, I/we hereby certify that each item listed and checked above has been covered by the installer and is clearly understood by the customer.

Customer's Signature

Date

Installer's Signature

Date

WARRANTY

ROTARY GATE SYSTEMS, INC. 5 YEAR LIMITED WARRANTY

Rotary Gate Systems, Inc. warrants to the original installing dealer of the SL-1000 gate operator that it will be free from defects in materials and workmanship for a period of five (5) years from the date of original purchase from Rotary Gate Systems. This warranty applies only to the SL-1000 gate operator and not to the APeX controller. A two (2) year warranty applies to the electronic control box including: APeX controller, power transformer and power box, batteries and limit switches. Rotary Gate Systems, Inc. warrants to the original installing dealer of the unit that it will be free from defects in materials and workmanship for a period of two (2) years from the date of original purchase from Rotary Gate System, Inc.

If the SL-1000 requires service, contact the dealer who originally installed it. If that dealer is not available, call 1-877-331-4747 to be referred to a dealer in your area.

THIS WARRANTY APPLIES ONLY TO THIS PRODUCT WHEN INSTALLED BY A QUALIFIED DEALER AND NOT TO ANY ACCESSORIES, THE GATE PANEL ITSELF, OR ANY GATE SUPPORT HARDWARE. THIS WARRANTY ONLY COVERS THE GATE OPERATOR AND CONTROLLER. THE INSTALLING DEALER MAY PROVIDE DIFFERING WARRANTIES FOR HIS SERVICES.

ALL WARRANTIES (IMPLIED OR UNIMPLIED) ARE LIMITED TO A PERIOD OF FIVE (5) YEARS. SOME STATES DO NOT ALLOW LIMITATIONS ON HOW LONG AN IMPLIED WARRANTY MAY LAST, SO THIS LIMITATION MAY NOT APPLY TO YOU.

ROTARY GATE SYSTEMS, INC. shall not be held liable for any consequential, incidental or special damages in connection with the installation, use or inability to use this product. The limitations of liability for ROTARY GATE SYSTEMS, INC. shall be limited to repair or replacement of this product.

Some states do not allow exclusion or limitation of consequential, incidental or special damages, so the preceding exclusions may not apply to you. This warranty gives you specific legal rights and you may have other rights which may vary from state to state.

This warranty is not transferable.