

# LiftMaster®

ELITE SERIES™

The Chamberlain Group, Inc.  
845 Larch Avenue  
Elmhurst, Illinois 60126-1196  
[www.liftmaster.com](http://www.liftmaster.com)

## SL3000UL™

### VEHICULAR SLIDE GATE OPERATOR



### OWNER'S MANUAL

THE SL3000UL™ IS FOR USE ON VEHICULAR PASSAGE GATES ONLY  
AND NOT INTENDED FOR USE ON PEDESTRIAN PASSAGE GATES.  
INTENDED FOR PROFESSIONAL INSTALLATION ONLY.

**UL325**  
compliant



**UL991**  
compliant



# TABLE OF CONTENTS

**! WARNING**  
*Mechanical*

**⚡ WARNING**  
*Electrical*

**CAUTION**

When you see these Safety Symbols and Signal Words on the following pages, they will alert you to the possibility of serious injury or death if you do not comply with the warnings that accompany them. The hazard may come from something mechanical or from electric shock. Read the warnings carefully.

When you see this Signal Word on the following pages, it will alert you to the possibility of damage to your gate and/or the gate operator if you do not comply with the cautionary statements that accompany it. Read them carefully.

**IMPORTANT NOTE:**

- **BEFORE** attempting to install, operate or maintain the operator, you must read and fully understand this manual and follow all safety instructions.
- **DO NOT** attempt repair or service of your gate operator unless you are an Authorized Service Technician.

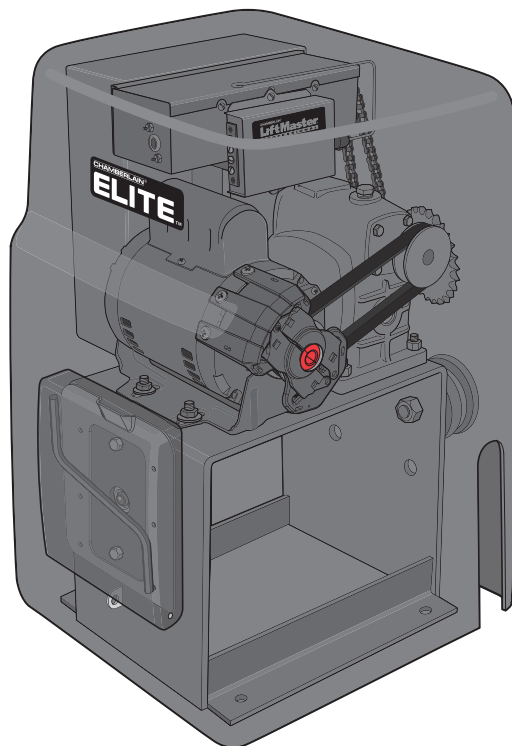

**SPECIFICATIONS AND WARNINGS**

Overview and Specifications . . . . . 2  
 Model Classification . . . . . 3  
 Safety Installation Information . . . . . 4  
 Gate Construction Information . . . . . 5  
 Safety Precautions . . . . . 6  
 Suggested Safety Protection Device Locations . . . . . 7-8

**INSTALLATION**

Installation Setups . . . . . 9  
 Safety Catch Rollers and Gate Rail Stops . . . . . 10  
 Mounting Operator . . . . . 11  
 Chain Installation Types . . . . . 12  
 Control Board Description . . . . . 13  
 Surge Suppressor Terminal Connections . . . . . 14

**WIRING**

Earth Ground Rod Installation . . . . . 15  
 120Vac Power Connection . . . . . 16  
 Heater Power Connection . . . . . 16  
 Linking Master/Second Operators . . . . . 17  
 Solenoid/Maglock Connection . . . . . 18  
 Factory Installed DC2000™ Connection . . . . . 19-20  
 Plug-In Loop Detector Wiring . . . . . 21  
 120Vac External Loop Detector Wiring . . . . . 22  
 Entrapment Protection Devices (Contact Sensors) . . . . . 23  
 Entrapment Protection Devices (Non-Contact Sensors) . . . . . 24  
 Omni Option Board Connections (Optional) . . . . . 25

**ADJUSTMENTS**

Set Gate Opening Direction . . . . . 26  
 Limit Switch Adjustments . . . . . 26  
 315 MHz 24Vdc Radio Receiver Programming . . . . . 27-28  
 Setting the Timer (On, Off) . . . . . 29  
 Adjusting Reversing Sensor(s) . . . . . 30

**MAINTENANCE AND OPERATION**

Maintenance . . . . . 31

**OPERATION**

Built-In Reset Switch . . . . . 32  
 Audio Alarm . . . . . 32

**EMERGENCY MANUAL RELEASE** . . . . . 33

**ACCESSORIES** . . . . . 34

**WIRING DIAGRAMS** . . . . . 35-42

**TROUBLESHOOTING** . . . . . 43-44

**REPAIR PARTS**

Repair Part Illustrations . . . . . 45  
 How to Order Repair Parts . . . . . 46  
 Part Names and Numbers . . . . . 46

**INSTALLATION CHECKLIST** . . . . . 47

**WARRANTY POLICY** . . . . . 48

# Specifications and Warnings

## SL3000UL™ MODELS OVERVIEW

### Single Motor Models

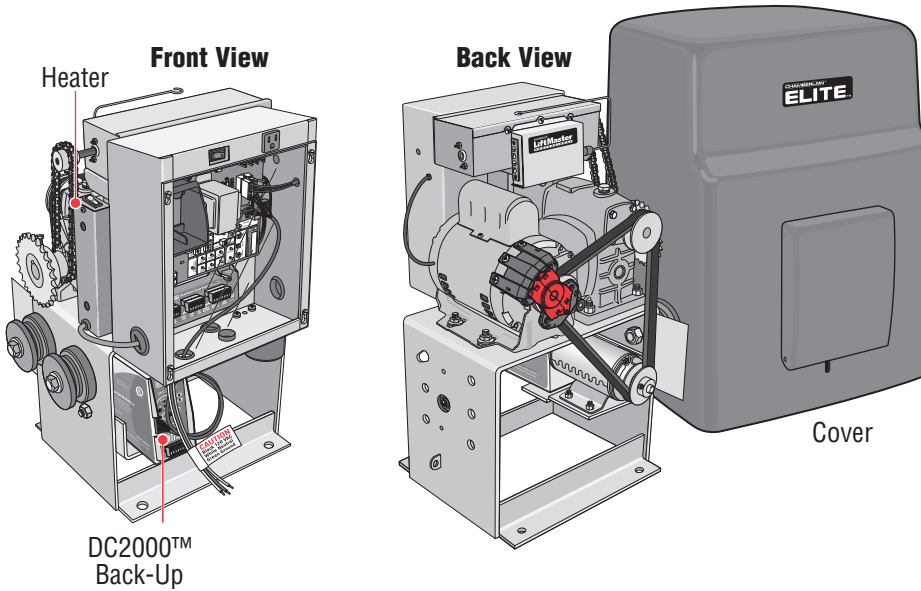

#### SL3000UL™ (Single Motor)

1/2 HP Motor, 120Vac, 4 Amp.  
Maximum Gate Length – 37 ft.  
Maximum Gate Weight – 1000 lbs.  
Maximum Pull – 105 lbs.

#### SL3000ULDC™ (Single Motor)

1/2 HP Motor, DC2000™, 120Vac, 4 Amp.  
Maximum Gate Length – 37 ft.  
Maximum Gate Weight – 1000 lbs.  
Maximum Pull – 105 lbs.

#### SL3000ULH™ (Single Motor)

1/2 HP Motor, 120Vac, 4 Amp., Heater 3 Amp  
Maximum Gate Length – 37 ft.  
Maximum Gate Weight – 1000 lbs.  
Maximum Pull – 105 lbs.

#### SL3000ULDCH™ (Single Motor)

1/2 HP Motor, DC2000™, 120Vac, 4 Amp., Heater 3 Amp  
Maximum Gate Length – 37 ft.  
Maximum Gate Weight – 1000 lbs.  
Maximum Pull – 105 lbs.

All operators come with 2 warning placards and a warranty card.

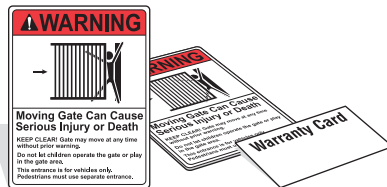

### Dual Motor and 1 HP Models

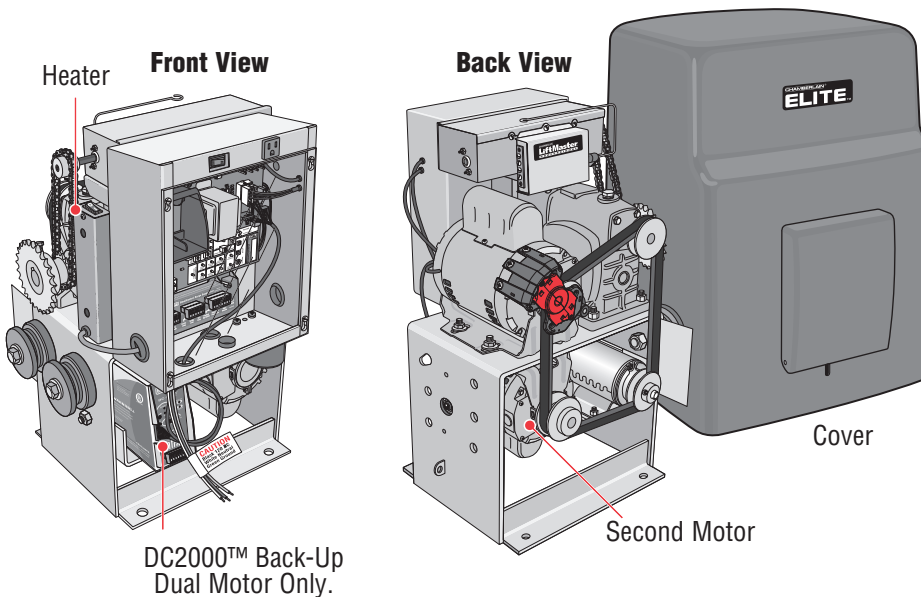

#### SL3000ULDM™ (Dual Motor)

Two-1/2 HP Motors, 120Vac, 4.7 Amp.  
Maximum Gate Length – 37 ft.  
Maximum Gate Weight – 800 lbs.  
Maximum Pull – 100 lbs.

#### SL3000ULDMDC™ (Dual Motor)

Two-1/2 HP Motors, DC2000™, 120Vac, 4.7 Amp.  
Maximum Gate Length – 37 ft.  
Maximum Gate Weight – 800 lbs.  
Maximum Pull – 100 lbs.

#### SL3000ULDMH™ (Dual Motor)

Two-1/2 HP Motors, 120Vac, 4.7 Amp., Heater 3 Amp  
Maximum Gate Length – 37 ft.  
Maximum Gate Weight – 800 lbs.  
Maximum Pull – 100 lbs.

#### SL3000ULDMDCH™ (Dual Motor)

Two-1/2 HP Motors, DC2000™, 120Vac, 4.7 Amp., Heater 3 Amp  
Maximum Gate Length – 37 ft.  
Maximum Gate Weight – 800 lbs.  
Maximum Pull – 100 lbs.

#### SL3000UL1HP™ (1 Horse Power)

Two-1/2 HP Motors, 120Vac, 8.4 Amp.  
Maximum Gate Length – 37 ft.  
Maximum Gate Weight – 2000 lbs.  
Maximum Pull – 180 lbs.

#### SL3000UL1HPH™ (1 Horse Power)

Two-1/2 HP Motors, 120Vac, 8.7 Amp., Heater 3 Amp  
Maximum Gate Length – 37 ft.  
Maximum Gate Weight – 2000 lbs.  
Maximum Pull – 180 lbs.

**NOTE:** The 1 HP models cannot have the DC2000™ Battery Backup system.

# UL325 MODEL CLASSIFICATIONS

The SL3000UL™ is intended for use in vehicular slide gate applications:



## Class I – Residential vehicular gate operator

A vehicular gate operator (or system) intended for use in a home of one-to four single family dwellings, or a garage or parking area associated therewith.

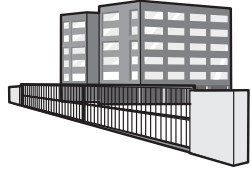

## Class II – Commercial/General access vehicular gate operator

A vehicular gate operator (or system) intended for use in a commercial location or building such as a multi-family housing unit (five or more single family units) hotel, garage, retail store or other building servicing the general public.

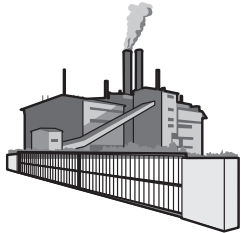

## Class III – Industrial/limited access vehicular gate operator

A vehicular gate operator (or system) intended for use in an industrial location or building such as a factory or loading dock area or other location not intended to service the general public.

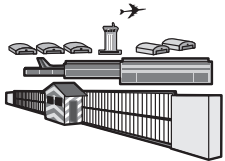

## Class IV – Restricted access vehicular gate operator

A vehicular gate operator (or system) intended for use in a guarded industrial location or building such as an airport security area or other restricted access locations not servicing the general public, in which unauthorized access is prevented via supervision by security personnel.

## UL325 ENTRAPMENT PROTECTION REQUIREMENTS

This chart illustrates the entrapment protection requirements for each of the four UL325 classes.

### GATE OPERATOR ENTRAPMENT PROTECTION

UL325 Installation Classification	Slide Gate Operator		Swing & Gate Barrier (Arm) Operator	
	Primary Type	Secondary Type	Primary Type	Secondary Type
<b>Class I</b> <b>Class II</b>	<b>A</b>	<b>B1, B2</b> or <b>D</b>	A or C	A, B1, C, or D, B2
<b>Class III</b>	<b>A, B1, B2</b> or <b>B2</b>	<b>A, B1,</b> <b>D</b> or <b>E</b>	A, B1, C or C	D or E
<b>Class IV</b>	<b>A, B1, B2</b> or <b>D</b>	<b>A, B1, B2,</b> <b>D</b> or <b>E</b>	A, B1, C or D	A, B1, C, D or E

In order to complete a proper installation you must satisfy the entrapment protection chart shown. That means that the installation must have one *primary* means of entrapment protection and one independent *secondary* means of entrapment protection. Both primary and secondary entrapment protection methods must be designed, arranged or configured to protect against entrapments in both the open and close directions of gate travel.

**For Example:** For a gate system that is installed on a single-family residence (UL325 Class I) you must provide the following: As your *primary type* of entrapment protection you must provide

- **Type A** - Inherent (built into the operator) entrapment sensing and at least one of the following as your *secondary entrapment protection*:
- **Type B1** - Non-contact sensors such as photo-eyes,
- **Type B2** - Contact sensors such as gate edges or
- **Type D** - Constant pressure control.
- **Type E** - Built-in audio alarm.

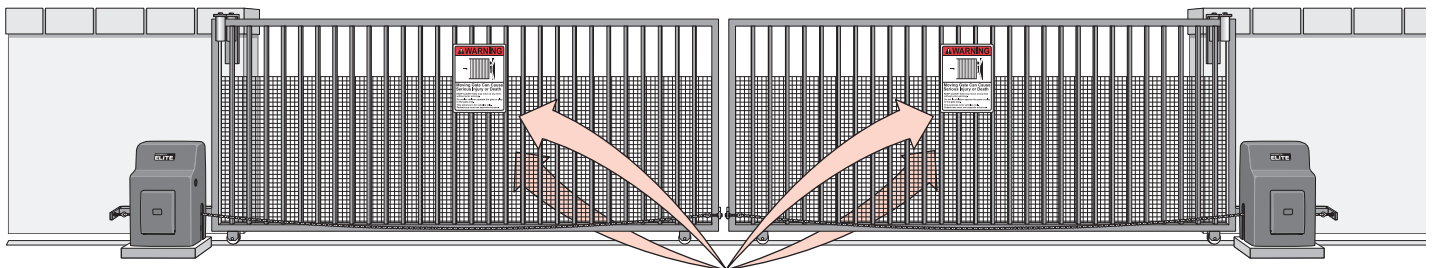

**NOTE:** UL requires that all installations must have warning signs placed in plain view on both sides of the gate to warn pedestrians of the dangers of motorized gate systems.

# SAFETY INSTALLATION INFORMATION

1. Vehicular gate systems provide convenience and security. Gate systems are comprised of many component parts. The gate operator is only one component. Each gate system is specifically designed for an individual application.
2. Gate operating system designers, installers and users must take into account the possible hazards associated with each individual application. Improperly designed, installed or maintained systems can create risks for the user as well as the bystander. Gate systems design and installation must reduce public exposure to potential hazards.
3. A gate operator can create high levels of force in its function as a component part of a gate system. Therefore, safety features must be incorporated into every design. Specific safety features include:
  - Gate Edges
  - Guards for Exposed Rollers
  - Photoelectric Sensors
  - Screen Mesh
  - Vertical Posts
  - Instructional and Precautionary Signage
4. Install the gate operator only when:
  - a. The operator is appropriate for the construction and the usage class of the gate.
  - b. All openings of a horizontal slide gate are guarded or screened from the bottom of the gate to a minimum of 4' (1.2 m) above the ground to prevent a 2 1/4" (6 cm) diameter sphere from passing through the openings anywhere in the gate, and in that portion of the adjacent fence that the gate covers in the open position.
  - c. All exposed pinch points are eliminated or guarded, and guarding is supplied for exposed rollers.
5. The operator is intended for installation only on gates used for vehicles. Pedestrians must be supplied with a separate access opening. The pedestrian access opening shall be designed to promote pedestrian usage. Locate the gate such that persons will not come in contact with the vehicular gate during the entire path of travel of the vehicular gate.
6. The gate must be installed in a location so that enough clearance is supplied between the gate and adjacent structures when opening and closing to reduce the risk of entrapment. Swinging gates shall not open into public access areas.
7. The gate must be properly installed and work freely in both directions prior to the installation of the gate operator.
8. Controls intended for user activation must be located at least six feet (6') away from any moving part of the gate and where the user is prevented from reaching over, under, around or through the gate to operate the controls. Outdoor or easily accessible controls shall have a security feature to prevent unauthorized use.
9. The Stop and/or Reset (if provided separately) must be located in the line-of-sight of the gate. Activation of the reset control shall not cause the operator to start.
10. A minimum of two (2) WARNING SIGNS shall be installed, one on each side of the gate where easily visible.
11. For a gate operator utilizing a non-contact sensor:
  - a. Reference owner's manual regarding placement of non-contact sensor for each type of application.
  - b. Care shall be exercised to reduce the risk of nuisance tripping, such as when a vehicle trips the sensor while the gate is still moving.
  - c. One or more non-contact sensors shall be located where the risk of entrapment or obstruction exists, such as the perimeter reachable by a moving gate or barrier.
12. For a gate operator utilizing a contact sensor such as an edge sensor:
  - a. One or more contact sensors shall be located where the risk of entrapment or obstruction exists, such as at the leading edge, trailing edge and post mounted both inside and outside of a vehicular horizontal slide gate.
  - b. One or more contact sensors shall be located at the bottom edge of a vehicular vertical lift gate.
  - c. A hard wired contact sensor shall be located and its wiring arranged so the communication between the sensor and the gate operator is not subject to mechanical damage.
  - d. A wireless contact sensor such as the one that transmits radio frequency (RF) signals to the gate operator for entrapment protection functions shall be located where the transmission of the signals are not obstructed or impeded by building structures, natural landscaping or similar obstruction. A wireless contact sensor shall function under the intended end-use conditions.
  - e. One or more contact sensors shall be located on the inside and outside leading edge of a swing gate. Additionally, if the bottom edge of a swing gate is greater than 6" (152 mm) above the ground at any point in its arc of travel, one or more contact sensors shall be located on the bottom edge.
  - f. One or more contact sensors shall be located at the bottom edge of a vertical barrier (arm).

# GATE CONSTRUCTION INFORMATION

Vehicular gates should be installed in accordance with ASTM F2200: Standard Specification for Automated Vehicular Gate Construction. For a copy, contact ASTM directly at 610-832-9585 or [www.astm.org](http://www.astm.org).

## 1. General Requirements

- 1.1 Gates shall be constructed in accordance with the provisions given for the appropriate gate type listed, refer to ASTM F2200 for additional gate types.
- 1.2 Gates shall be designed, constructed and installed to not fall over more than 45 degrees from the vertical plane, when a gate is detached from the supporting hardware.
- 1.3 Gates shall have smooth bottom edges, with vertical bottom edged protrusions not exceeding 0.50 inches (12.7 mm) when other than the exceptions listed in ASTM F2200.
- 1.4 The minimum height for barbed tape shall not be less than 8 feet (2.44 m) above grade and for barbed wire shall not be less than 6 feet (1.83 m) above grade.
- 1.5 An existing gate latch shall be disabled when a manually operated gate is retrofitted with a powered gate operator.
- 1.6 A gate latch shall not be installed on an automatically operated gate.
- 1.7 Protrusions shall not be permitted on any gate, refer to ASTM F2200 for Exceptions.
- 1.8 Gates shall be designed, constructed and installed such that their movement shall not be initiated by gravity when an automatic operator is disconnected.
- 1.9 A pedestrian gate shall not be incorporated into a vehicular gate panel or that portion of the adjacent fence that the gate covers in the open position.

## 2. Specific Applications

- 2.1 Any non-automated gate that is to be automated shall be upgraded to conform to the provisions of this specification.
- 2.2 This specification shall not apply to gates generally used for pedestrian access and to vehicular gates not to be automated.
- 2.3 Any existing automated gate, when the operator requires replacement, shall be upgraded to conform to the provisions of this specification in effect at that time.

## 3. Vehicular Horizontal Slide Gates

- 3.1 The following provisions shall apply to Class I, Class II and Class III vehicular horizontal slide gates:
  - 3.1.1 All weight bearing exposed rollers 8 feet (2.44 m), or less, above grade shall be guarded or covered.
  - 3.1.2 All openings located between 48 inches (1.22 m) and 72 inches (1.83 m) above grade shall be designed, guarded or screened to prevent a 4 inch (102 mm) diameter sphere from passing through the openings anywhere in the gate, and in that portion of the adjacent fence that covers in the open position.

- 3.1.3 A gap, measured in the horizontal plane parallel to the roadway, between a fixed stationary object nearest the roadway, (such as a gate support post) and the gate frame when the gate is in either the fully open position or the fully closed position, shall not exceed 2-1/4 inches (57 mm), refer to ASTM F2200 for Exception.
- 3.1.4 Positive stops shall be required to limit travel to the designed fully open and fully closed positions. These stops shall be installed at either the top of the gate, or at the bottom of the gate where such stops shall horizontally or vertically project no more than is required to perform their intended function.
- 3.1.5 All gates shall be designed with sufficient lateral stability to assure that the gate will enter a receiver guide, refer to ASTM F2200 for panel types.
- 3.2 The following provisions shall apply to Class IV vehicular horizontal slide gates:
  - 3.2.1 All weight bearing exposed rollers 8 feet (2.44 m), or less, above grade shall be guarded or covered.
  - 3.2.2 Positive stops shall be required to limit travel to the designed fully open and fully closed positions. These stops shall be installed at either the top of the gate, or at the bottom of the gate where such stops shall horizontally or vertically project no more than is required to perform their intended function.

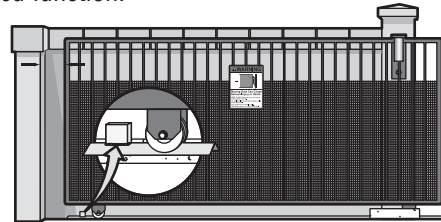

## 4. Vehicular Horizontal Swing Gates

- 4.1 The following provisions shall apply to Class I, Class II and Class III vehicular horizontal swing gates:
  - 4.1.1 Gates shall be designed, constructed and installed so as not to create an entrapment area between the gate and the supporting structure or other fixed object when the gate moves toward the fully open position, subject to the provisions in the 4.1.1.1 and 4.1.1.2.
    - 4.1.1.1 The width of an object (such as a wall, pillar or column) covered by a swing gate when in the open position shall not exceed 4 inches (102 mm), measured from the centerline of the pivot point of the gate, refer to ASTM F2200 for exception.
    - 4.1.1.2 Except for the zone specified in Section 4.1.1.1, the distance between a fixed object such as a wall, pillar or column, and a swing gate when in the open position shall not be less than 16 inches (406 mm), refer to ASTM F2200 for exception.
  - 4.2 Class IV vehicular horizontal swing gates shall be designed, constructed and installed in accordance with security related parameters specific to the application in question.

# SAFETY PRECAUTIONS

**THE SL3000UL™ IS FOR USE ON VEHICULAR PASSAGE GATES ONLY  
AND NOT INTENDED FOR USE ON PEDESTRIAN PASSAGE GATES.**

## WARNING

To prevent SERIOUS INJURY or DEATH from a moving gate:

- Entrapment protection devices **MUST** be installed to protect anyone who may come near a moving gate.
- Locate entrapment protection devices to protect in **BOTH** the open and close gate cycles.
- Locate entrapment protection devices to protect between moving gate and **RIGID** objects, such as posts or walls.

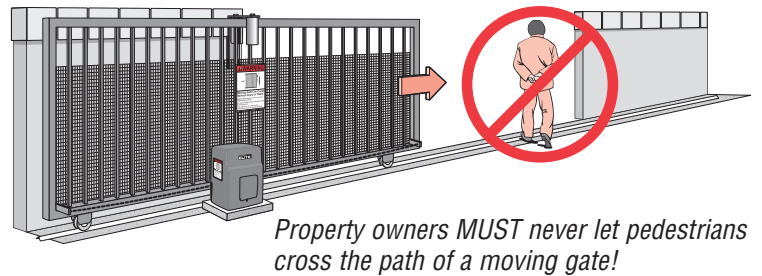
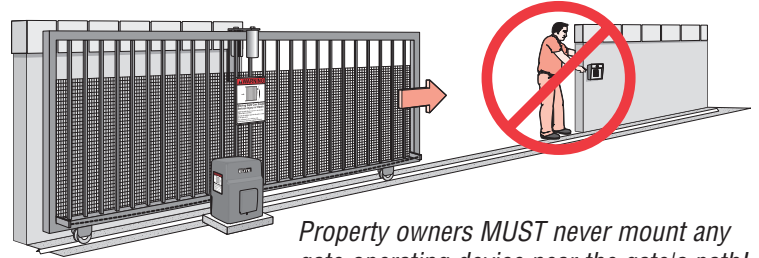

## WARNING SIGN PLACEMENT

### WARNING

To prevent SERIOUS INJURY or DEATH from a moving gate:  
Install Warning signs on **BOTH** sides of **EACH** gate,  
in **PLAIN VIEW**.

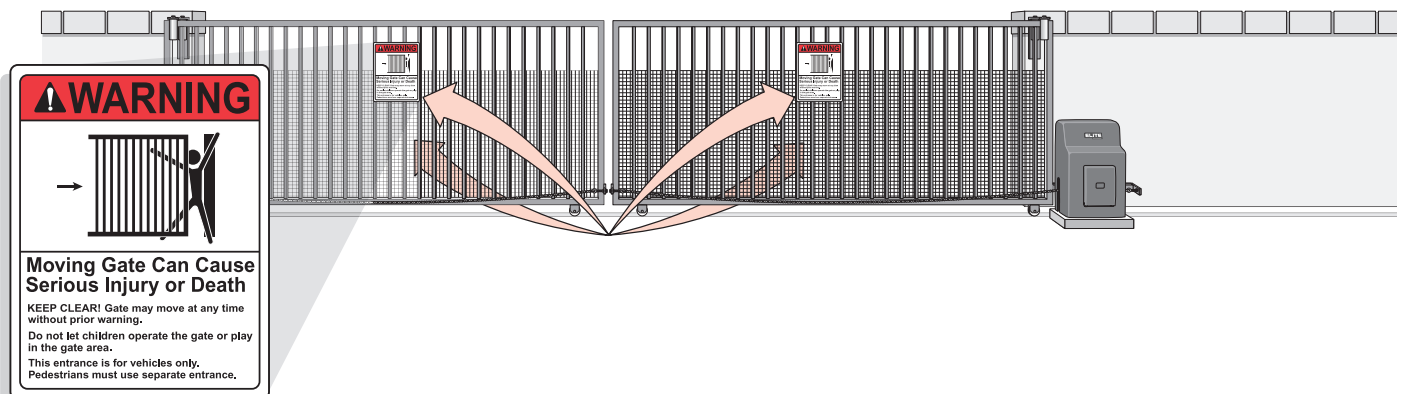



# SUGGESTED SAFETY PROTECTION DEVICE LOCATIONS

## ⚠️ WARNING

To prevent SERIOUS INJURY or DEATH from a moving gate:

- Entrapment protection devices **MUST** be installed to protect anyone who may come near a moving gate.
- Locate entrapment protection devices to protect in **BOTH** the open and close gate cycles.
- Locate entrapment protection devices to protect between moving gate and **RIGID** objects, such as posts or walls.

### ***Non-Contact Sensors (Photoelectric Sensors)***

Install **photoelectric sensors** to protect against any entrapment or safety conditions encountered in your gate application.

See Entrapment Protection Devices.

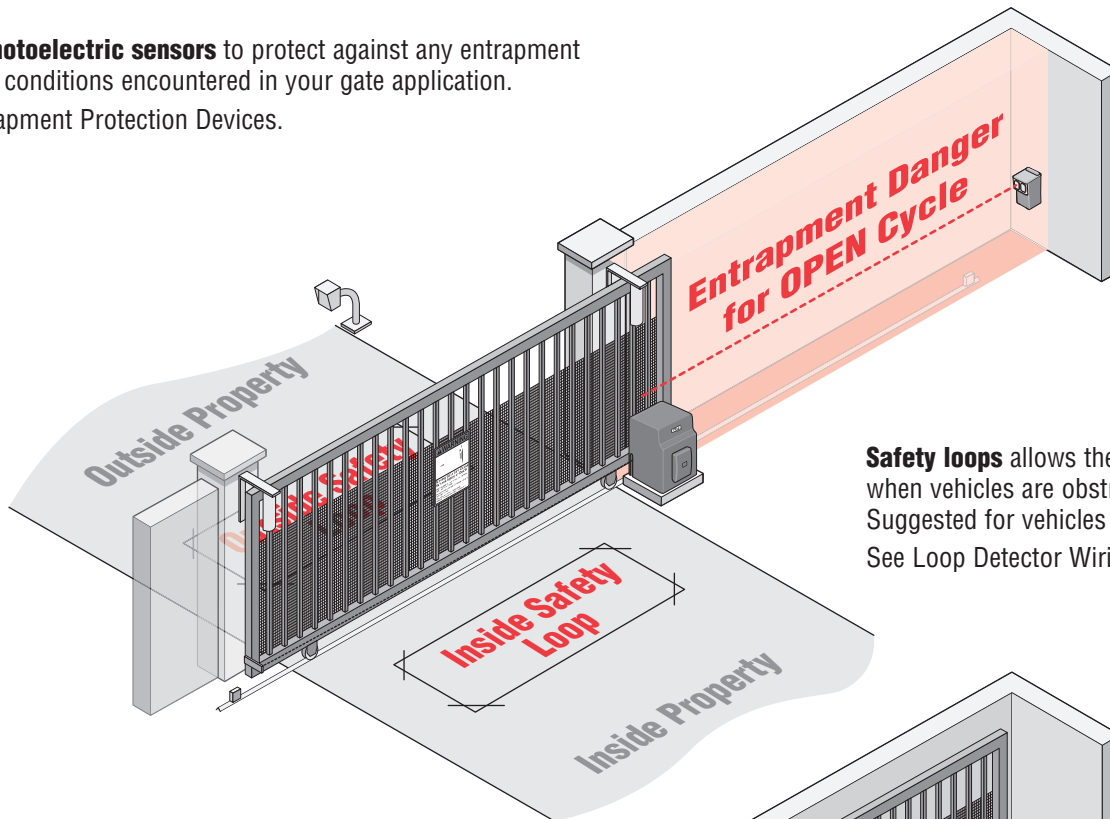

**Safety loops** allows the gate to stay open when vehicles are obstructing the gate path. Suggested for vehicles 14 feet or longer. See Loop Detector Wiring.

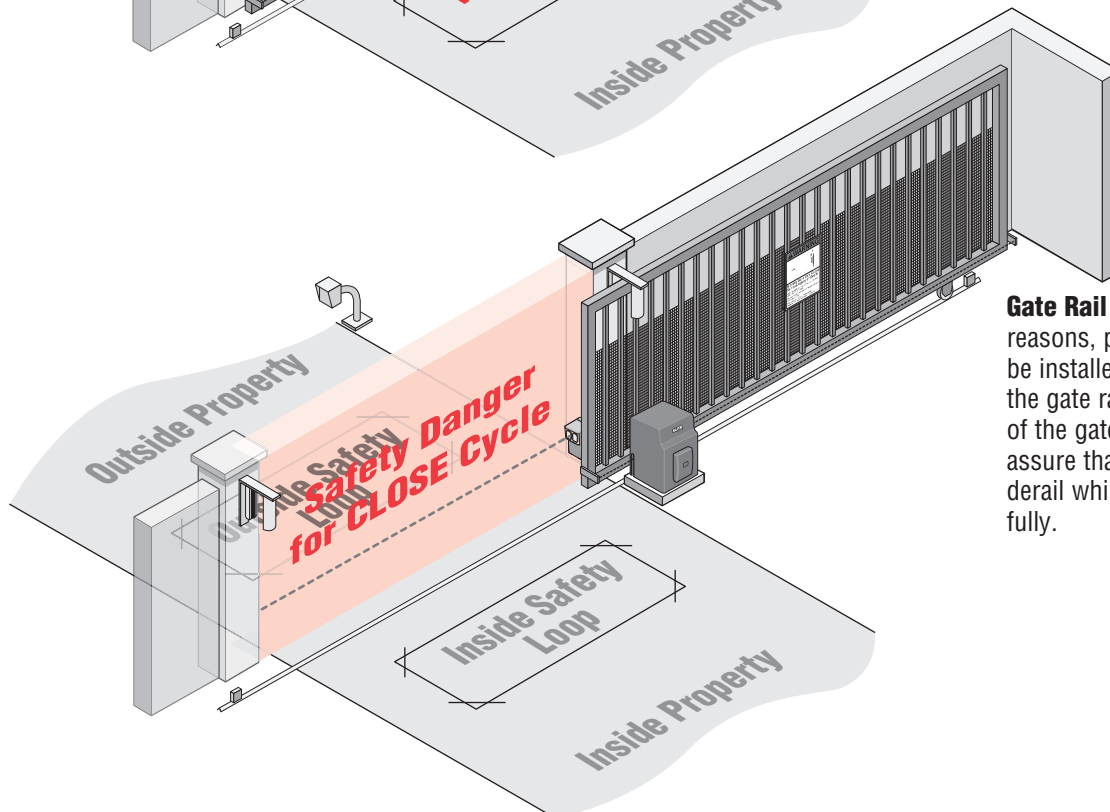

**Gate Rail Stops** For safety reasons, physical stops **MUST** be installed on both ends of the gate rail prior to installation of the gate operator. This will assure that the gate does not derail while opening or closing fully.

# SUGGESTED SAFETY PROTECTION DEVICE LOCATIONS

## ⚠️ WARNING

To prevent SERIOUS INJURY or DEATH from a moving gate:

- Entrapment protection devices **MUST** be installed to protect anyone who may come near a moving gate.
- Locate entrapment protection devices to protect in **BOTH** the open and close gate cycles.
- Locate entrapment protection devices to protect between moving gate and **RIGID** objects, such as posts or walls.

## Contact Sensors (Edge Sensors)

Install **edge sensors** to protect against any entrapment or safety conditions encountered in your gate application.

See Entrapment Protection Devices.

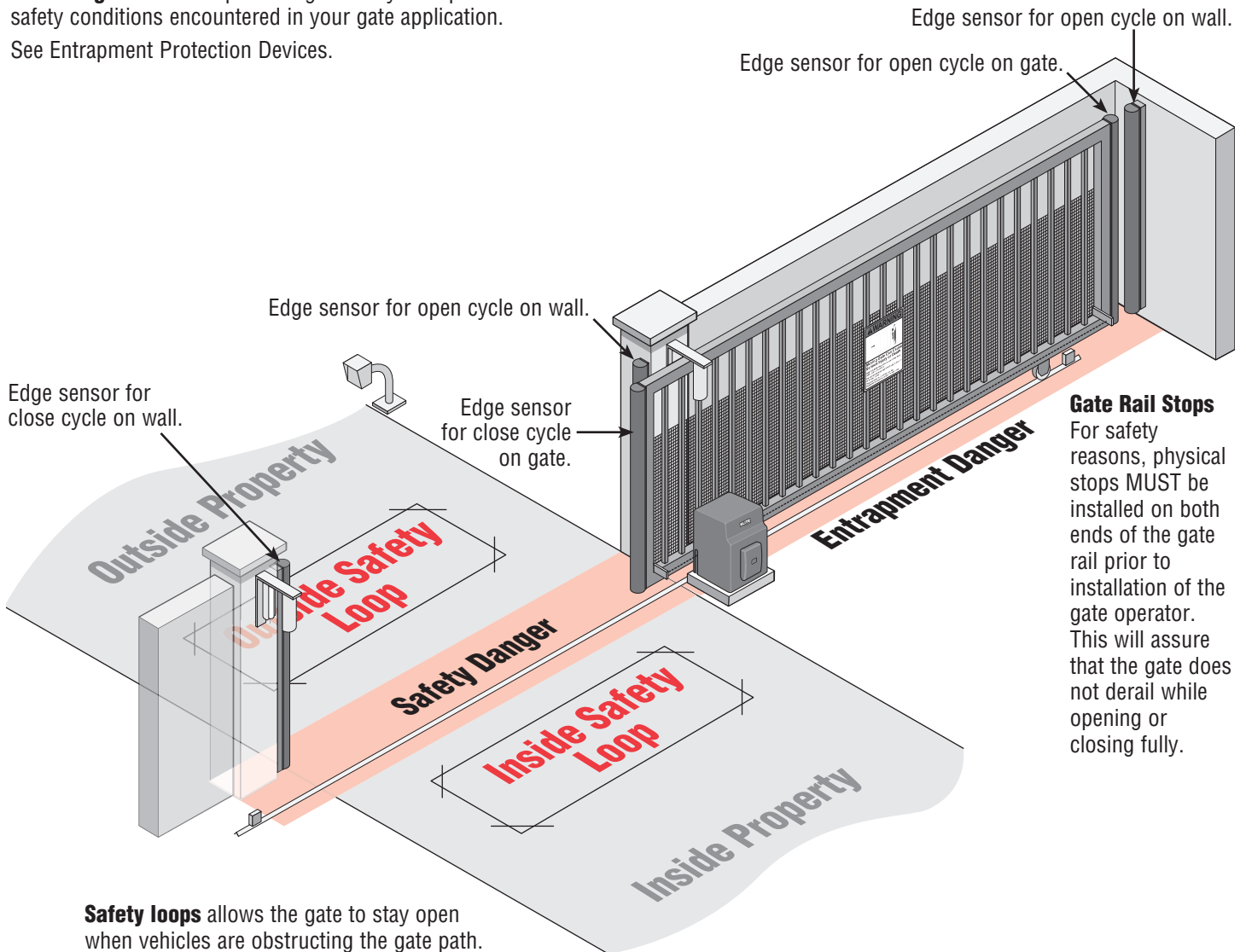

**Gate Rail Stops**  
For safety reasons, physical stops **MUST** be installed on both ends of the gate rail prior to installation of the gate operator. This will assure that the gate does not derail while opening or closing fully.

**Safety loops** allows the gate to stay open when vehicles are obstructing the gate path. Suggested for vehicles 14 feet or longer. See Loop Detector Wiring.

# Installation

## INSTALLATION SETUPS

### Front or Rear Position with Single Operator

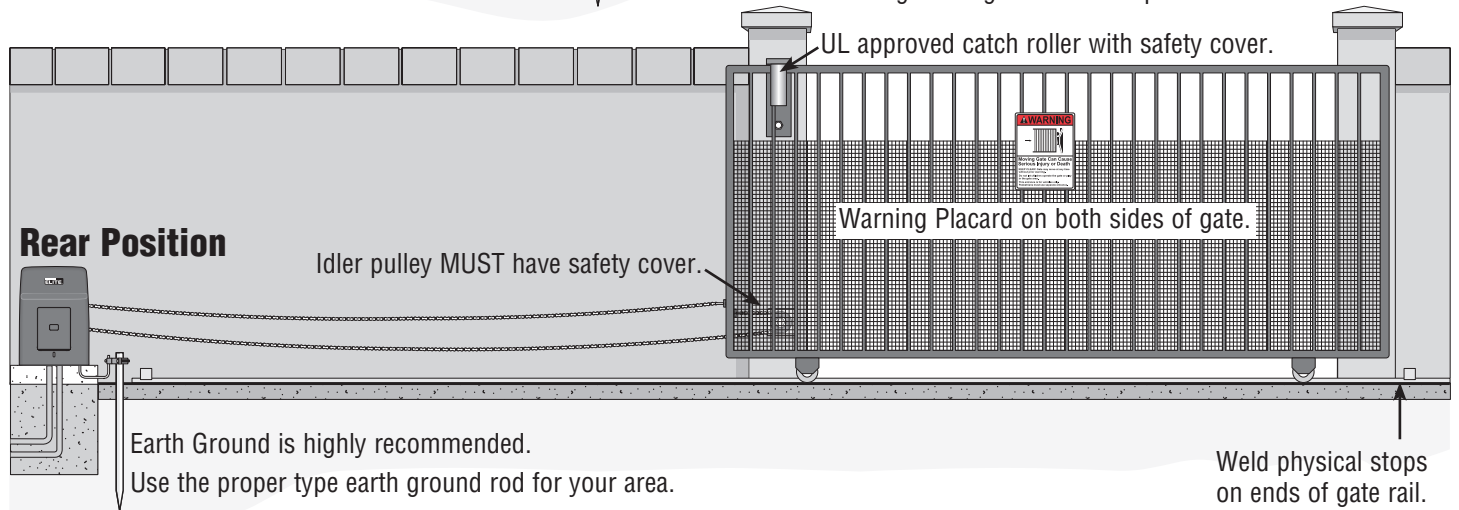
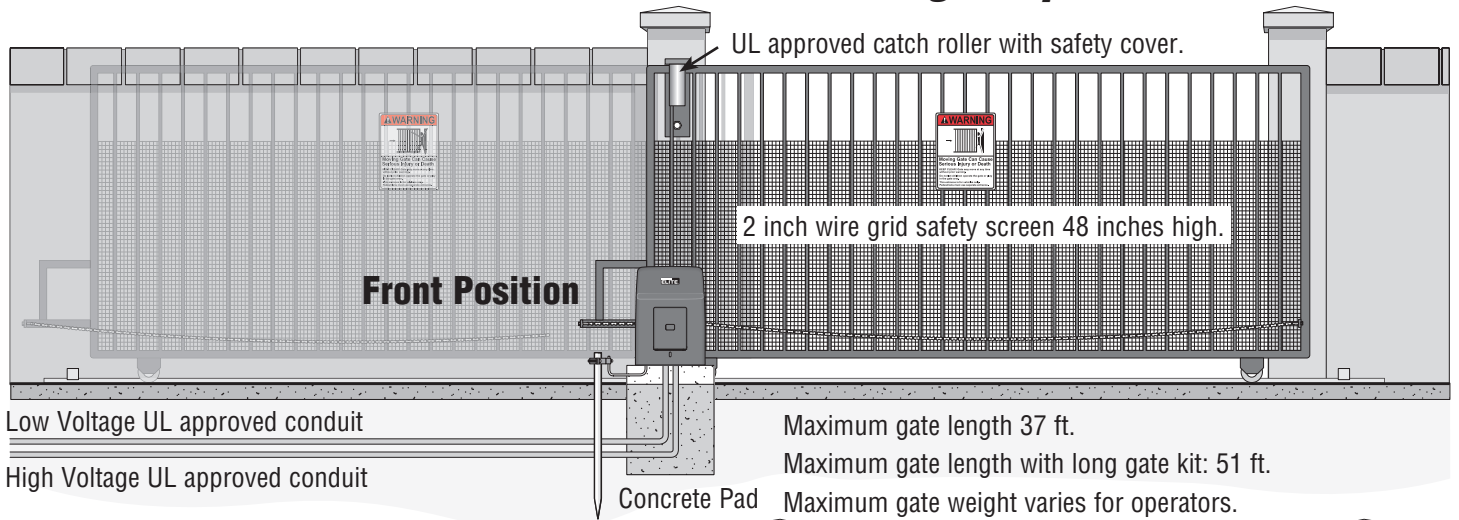

### Master/Second Operators

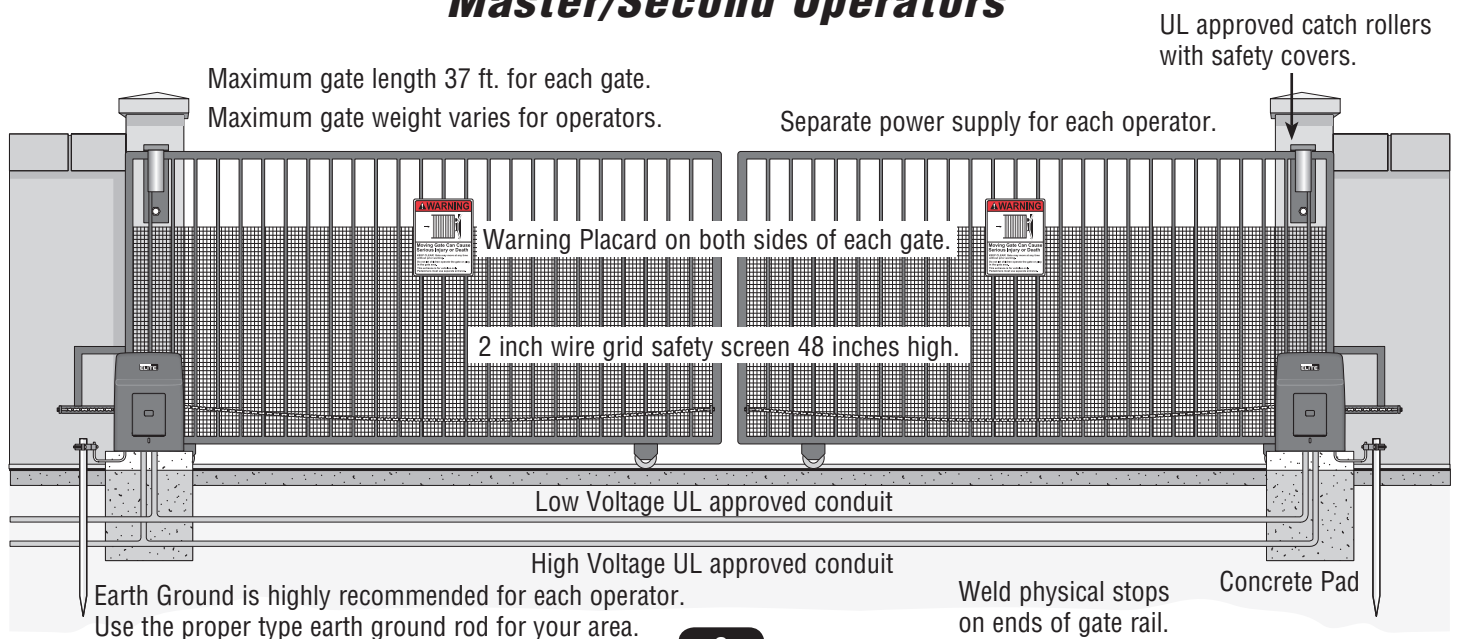

# SAFETY CATCH ROLLERS AND GATE RAIL STOPS

## Safety Catch Rollers

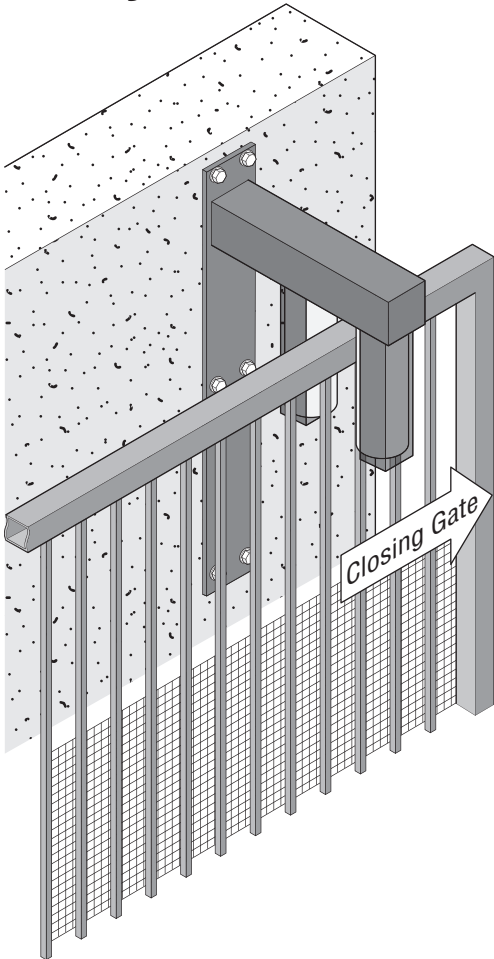

**DO NOT use a Gate Catch Post.**

Because the coasting distance may vary due to changes in temperature, it is **NOT** recommended to install a stop or catch post in **front** of the gates path. To do so will cause the gate to hit the post in certain instances.

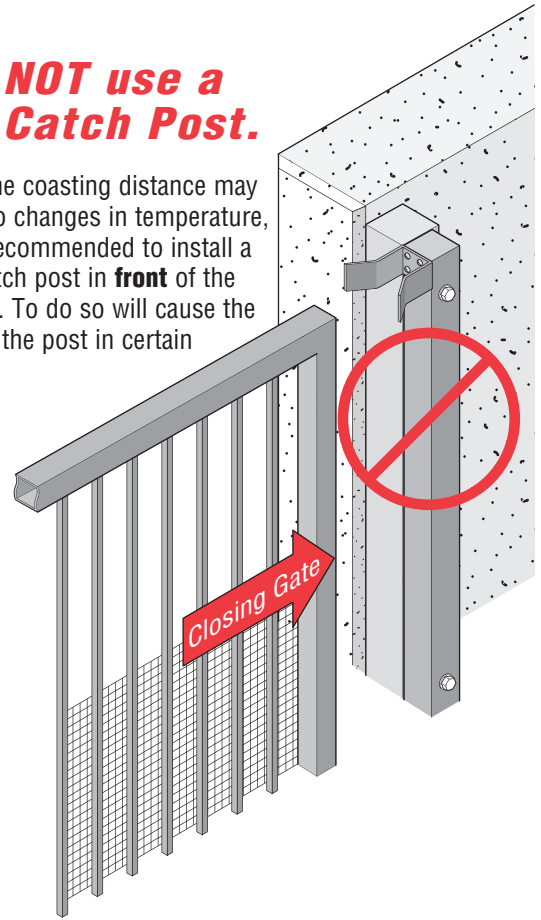

It is only recommended installing **catch rollers with safety covers** on the side of a post or wall with a minimal distance of **half an inch** between the rollers and gate.

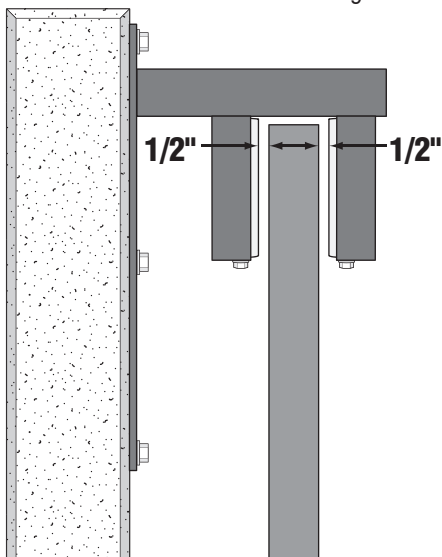

End View of Gate and Wall

## Gate Rail Stop

When fully opened, the end of the sliding gate should stop at least **five** inches from an obstructing wall.

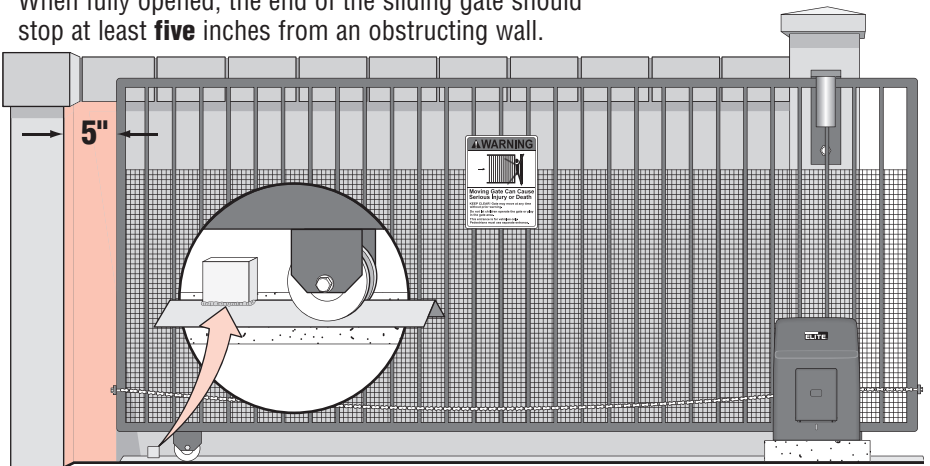

**NOTE:** For safety reasons, physical stops **MUST** be installed on both ends of the gate rail prior to installation of the gate operator. This will assure that the gate does not derail while opening or closing fully.

# MOUNTING OPERATOR

## Top Inside View

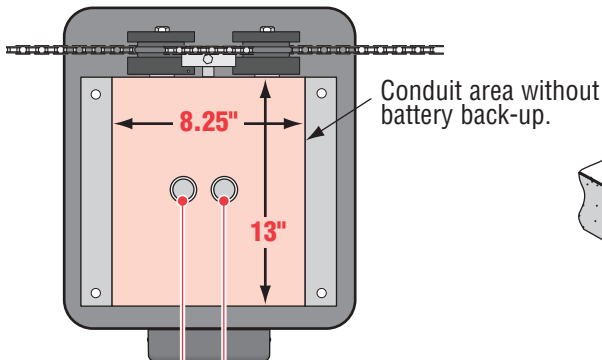

High voltage conduit.

Low voltage conduit.

Suggested installation for dirt ground. The measurements depend on the type of ground (ie., asphalt, cement, dirt). Check local building codes before installation.

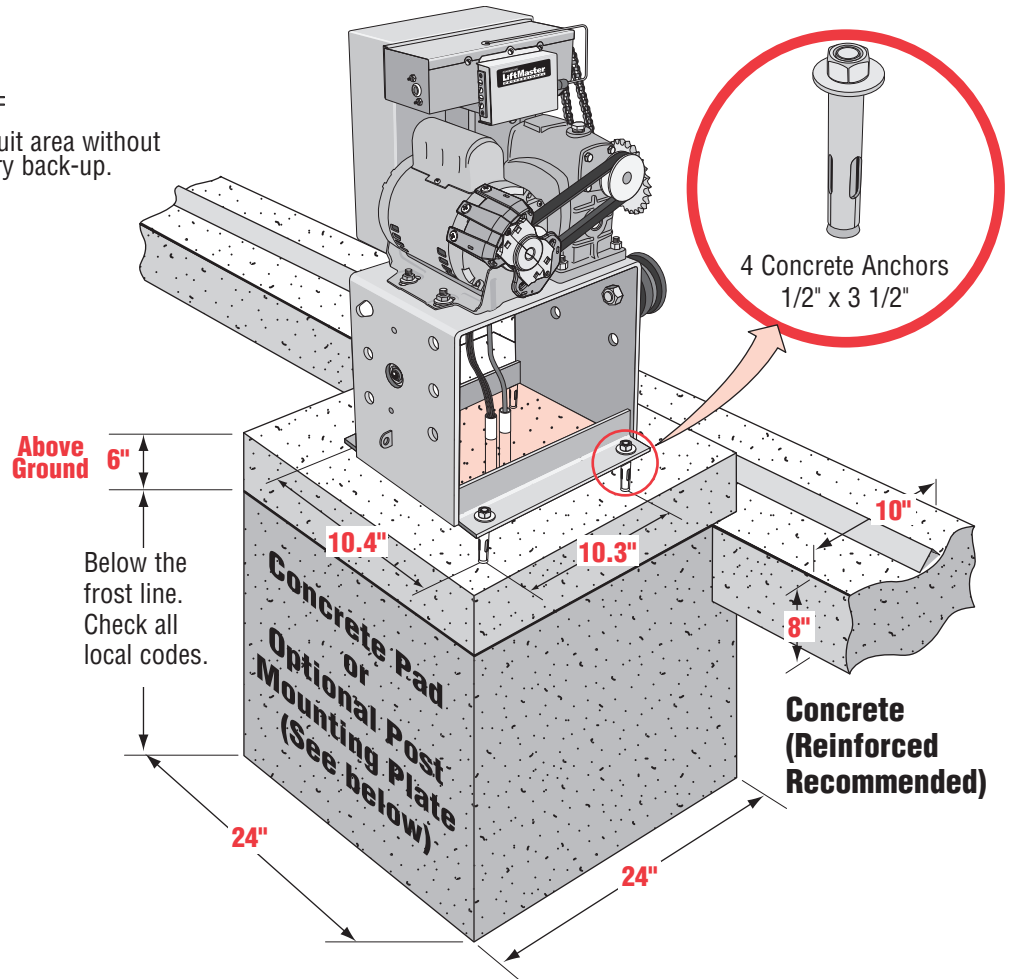

# POST MOUNTING PLATE (OPTIONAL)

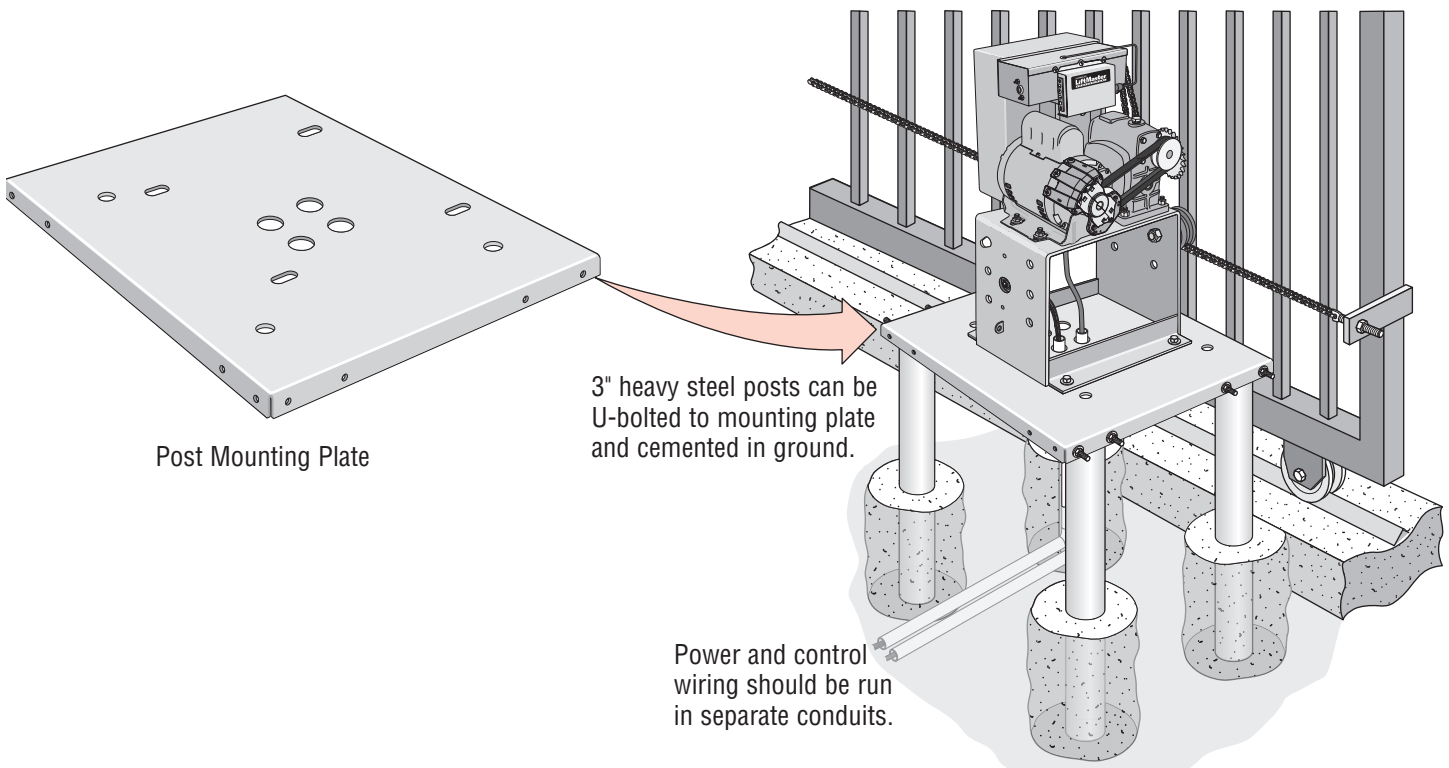

# CHAIN INSTALLATION TYPES

Drawings not to scale

## Front Operator Position

Weld rear bracket with gate in **closed position**

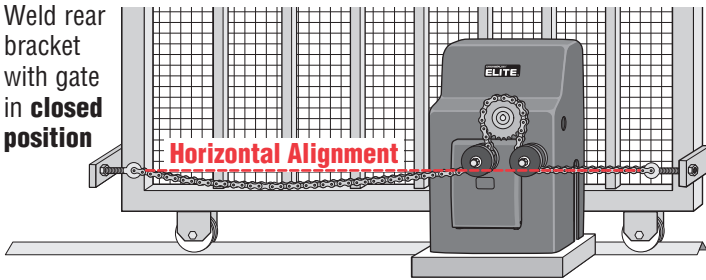

Weld front bracket with gate in **open position**.

**! WARNING**

To reduce the risk of **SERIOUS INJURY** or **DEATH**, make sure exposed idler pulleys have safety covers on them.

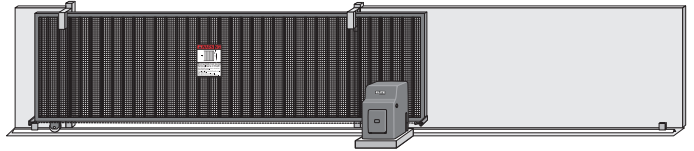

## Rear Operator Position

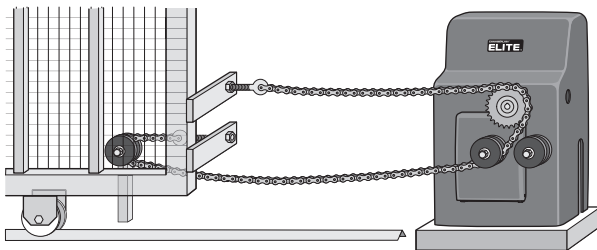

Cut the chain slot 17 1/2" high on cover.

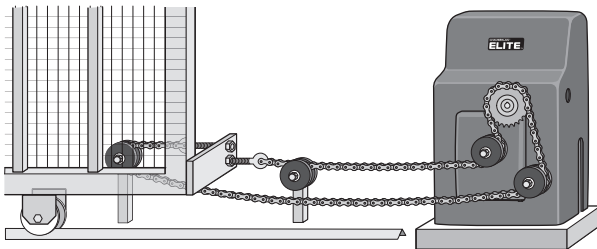
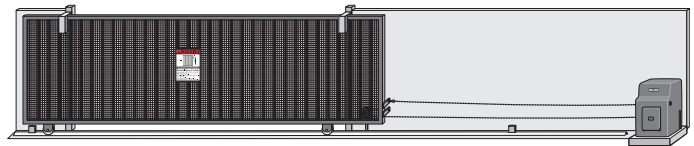

Low idler pulley position.

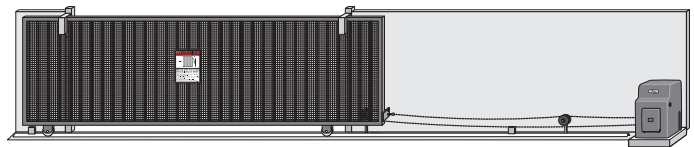

# CHAIN DISTANCE AND HEIGHT ON GATE

## CORRECT INSTALLATION

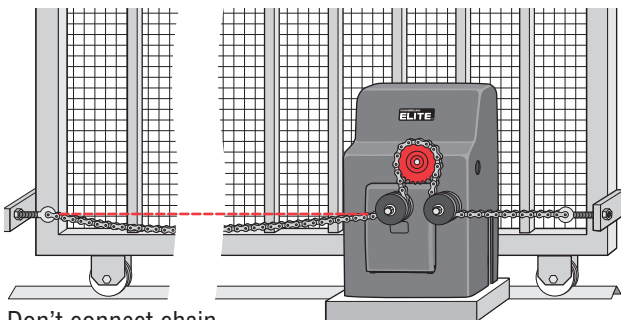

Don't connect chain **too tight** to gate.

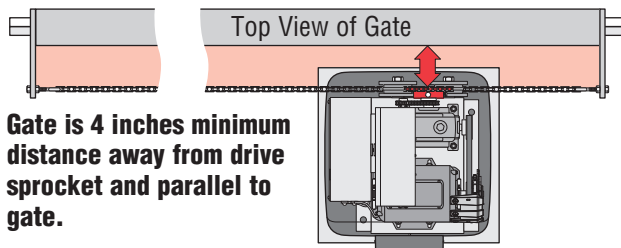

Gate is 4 inches minimum distance away from drive sprocket and parallel to gate.

## INCORRECT INSTALLATION

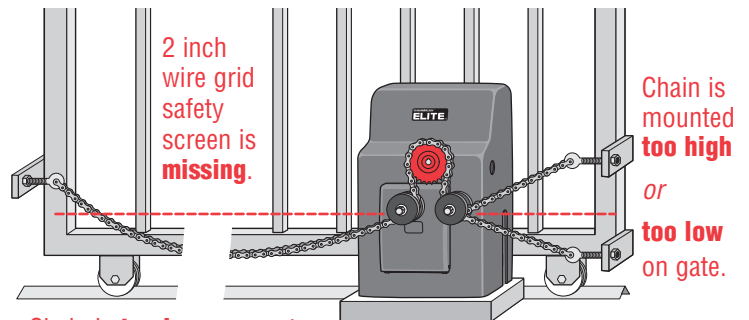

Chain is **too loose** on gate.

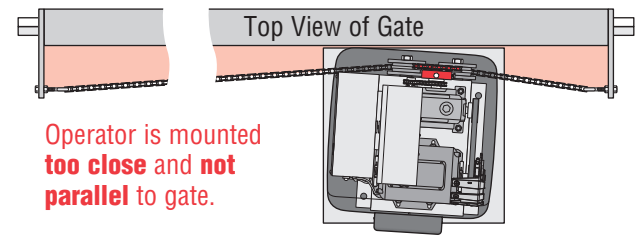

Operator is mounted **too close** and **not parallel** to gate.

Over time, the gate's chain will stretch out and need to have links removed from it. The links can be removed during normal periodic maintenance of the operator.

# CONTROL BOARD DESCRIPTION

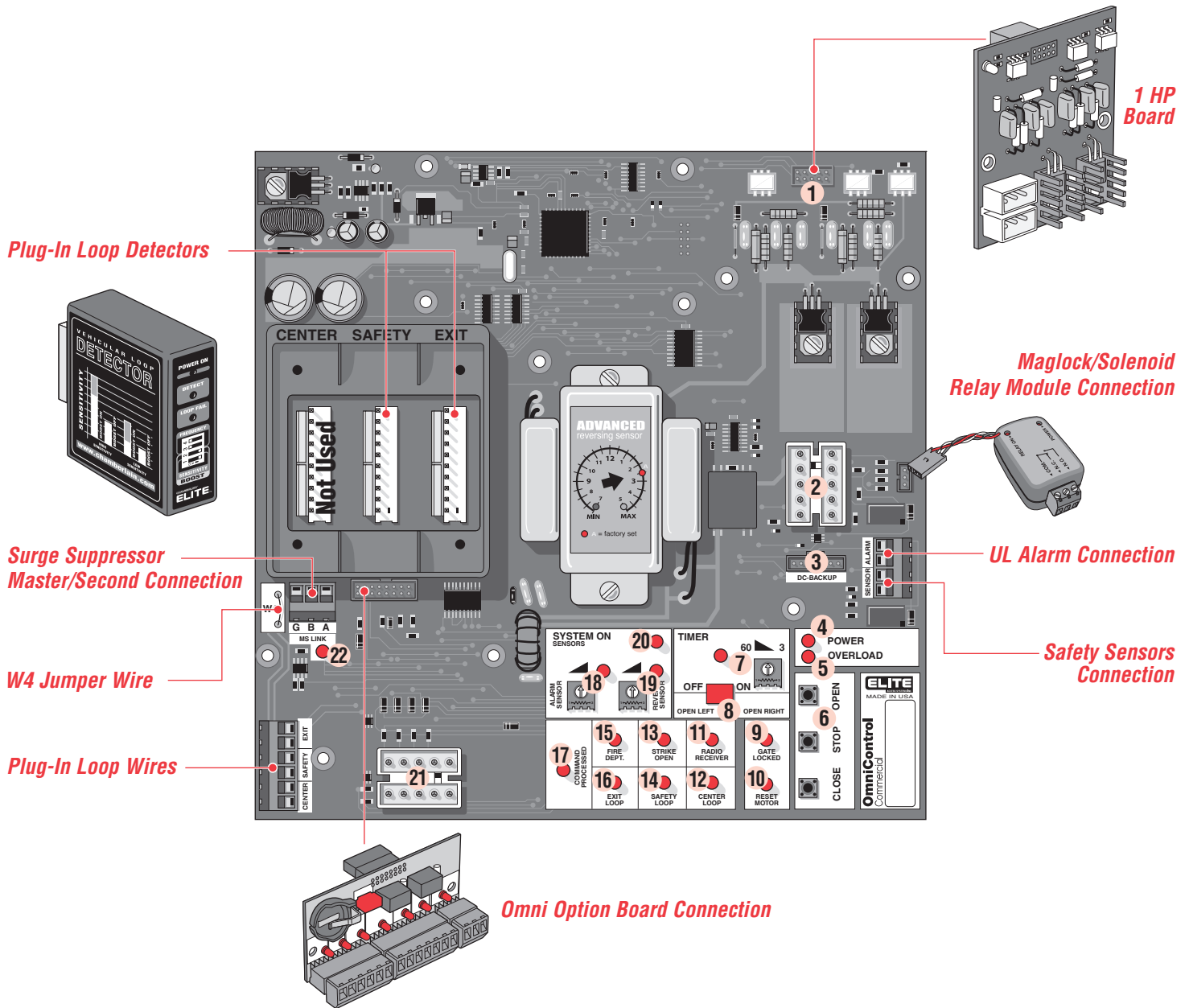

- 1 1HP Connection** - Factory installed SL3000UL1HP™ Models.
- 2 J3 Motor, Limit Switch, Maglock/Solenoid Connection**
- 3 DC2000™ Back-Up Power or Reset Switch/Interlock Connection**
- 4 Circuit Board Power LED** - Operator power OK when ON.
- 5 Overload LED** - Operator power has overloaded when ON.
- 6 On-Board 3 Button Station** - Close, Stop, Open commands.
- 7 Timer** - Timed close, see page 29.
- 8 Gate Opening Direction Selector** - Open Left, Open Right.
- 9 Gate Locked LED** - Maglock/Solenoid is activated when on.
- 10 Reset Motor LED** - Cycle operator power when ON.
- 11 Radio Receiver LED** - Radio transmitter is activated when ON.
- 12 Center Loop LED** - Center loop detector activated when ON.
- 13 Strike Open LED** - Strike connected device activated when ON.
- 14 Safety Loop LED** - Safety loop detector activated when ON.
- 15 Fire Dept LED** - Key Switch activated when ON.
- 16 Exit Loop LED** - Exit loop detector activated when ON.
- 17 Command Processed LED** - Successful command executed.
- 18 Alarm Sensor** - Limited Adjustment, page 30.
- 19 Reverse Sensor** - Gate hit obstruction when ON. See page 30.
- 20 System On LED** - Operator is successfully performing a command.
- 21 J1 Surge Suppressor Data Connection**
- 22 M/S Link LED** - Data being transferred between master and second operators when ON.

# SURGE SUPPRESSOR TERMINAL CONNECTIONS

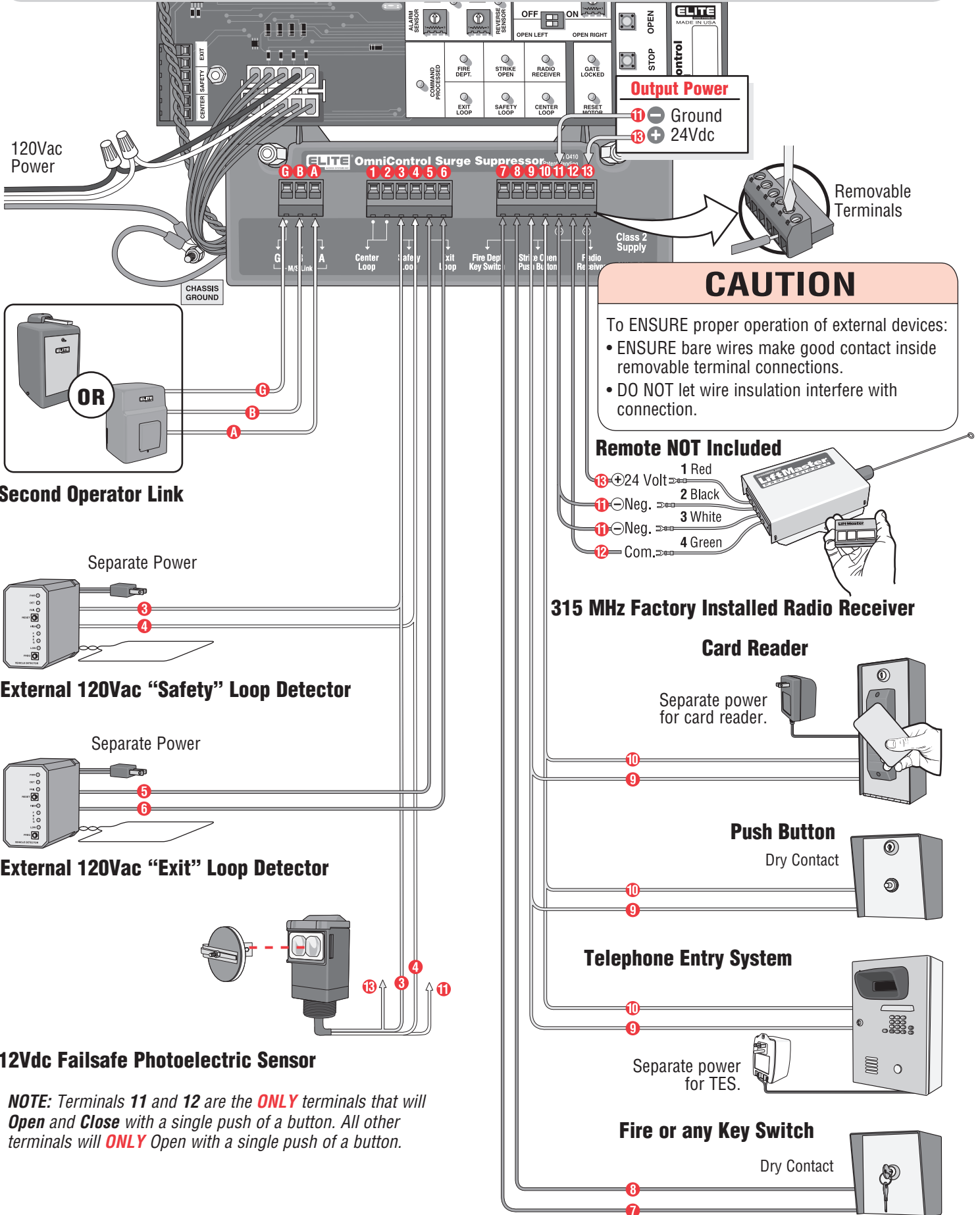



# Wiring

## ⚡ ⚠ WARNING

To reduce the risk of SEVERE INJURY or DEATH:

- ANY maintenance to the operator or in the area near the operator MUST NOT be performed until disconnecting the electrical power and locking-out the power. Upon completion of maintenance the area MUST be cleared and secured, at that time the unit may be returned to service.
- Disconnect power at the fuse box BEFORE proceeding. Operator MUST be properly grounded and connected in accordance with local electrical codes.

**NOTE:** The operator should be on a separate fused line of adequate capacity.

- ALL electrical connections MUST be made by a qualified individual.

- DO NOT install ANY wiring or attempt to run the operator without consulting the wiring diagram. We recommend that you install an optional reversing edge BEFORE proceeding with the control station installation.
- ALL power wiring should be on a dedicated circuit and well protected. The location of the power disconnect should be visible and clearly labeled.
- ALL power and control wiring MUST be run in separate conduit.
- BEFORE installing power wiring or control stations be sure to follow ALL specifications and warnings described below. Failure to do so may result in SEVERE INJURY to persons and/or damage to operator.

All power wiring should be on a dedicated circuit and well protected.

**NOTE:** Calculated using NEC guidelines. Local codes and conditions must be reviewed for suitability of wire installation.

120Vac Power Wire	16 Gauge	14 Gauge	12 Gauge	10 Gauge	8 Gauge	4 Gauge
1/2 HP and Dual Motor	up to 150 FT	250 FT	400 FT	650 FT	1000 FT	2200 FT
1 HP	up to 75 FT	125 FT	200 FT	325 FT	500 FT	1100 FT

## ⚠ WARNING

To prevent SERIOUS INJURY or DEATH from a moving gate: DO NOT disconnect the built-in audio alarm or reset switch.

## EARTH GROUND ROD INSTALLATION

### CAUTION

To AVOID damaging gas, power, or other underground utility lines, contact underground utility locating companies BEFORE digging.

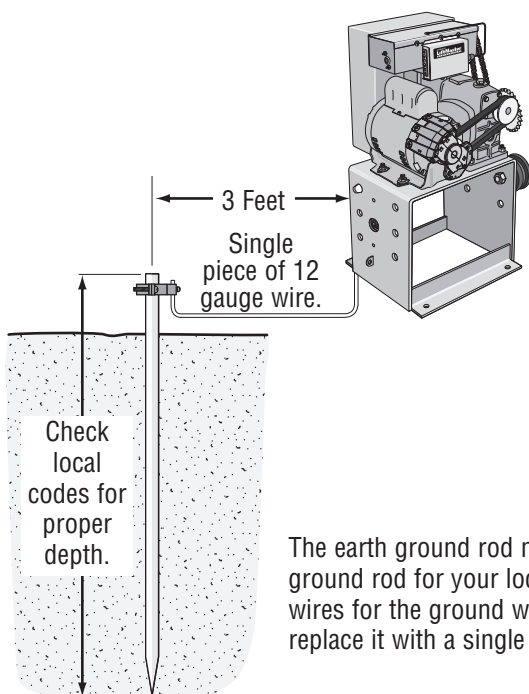

Proper grounding gives an electrical charge, such as from an electrical static discharge or a near lightning strike, a path from which to dissipate its energy safely into the earth.

Without this path, the intense energy generated by lightning could be directed towards the gate operator. Although nothing can absorb the tremendous power of a direct lightning strike, proper grounding can protect the gate operator in most cases.

The earth ground rod must be located within 3 feet from the gate operator. Use the proper type earth ground rod for your local area. The ground wire must be a single, whole piece of wire. Never splice two wires for the ground wire. If you should cut the ground wire too short, break it, or destroy its integrity, replace it with a single wire length.

# 120VAC POWER CONNECTION

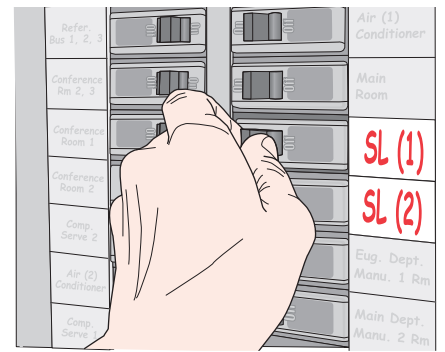
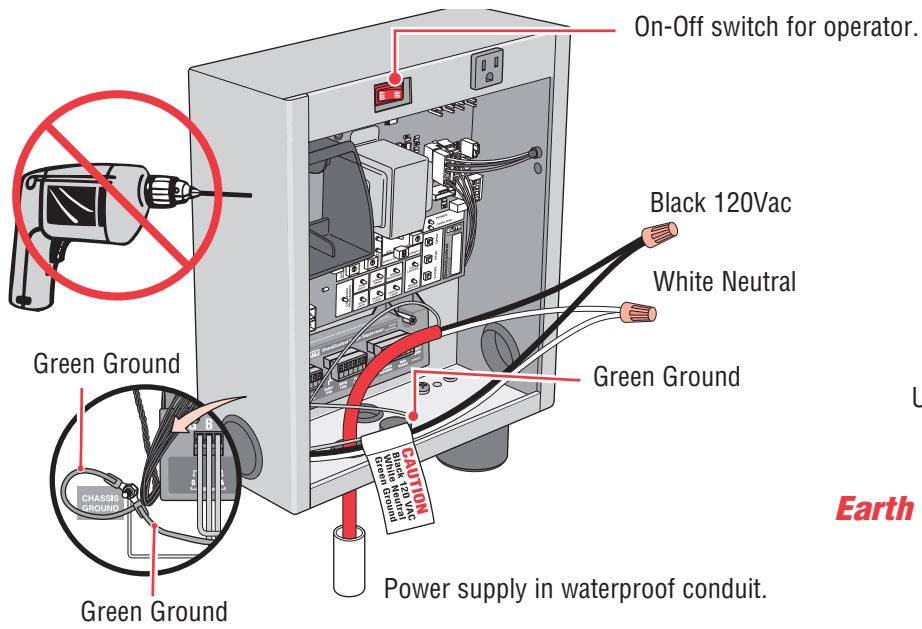

Use a 20 amp dedicated circuit for each operator.  
Input power 120Vac, 60 Hz.

**Earth Ground Rod Highly Recommended!**  
See previous page.

120Vac Power Wire	16 Gauge	14 Gauge	12 Gauge	10 Gauge	8 Gauge	4 Gauge
1/2 HP and Dual Motor	up to 150 FT	250 FT	400 FT	650 FT	1000 FT	2200 FT
1 HP	up to 75 FT	125 FT	200 FT	325 FT	500 FT	1100 FT

# HEATER POWER CONNECTION

Connect the black, white and ground wire from the heater to the 120Vac power supply as shown. When the heater switch is left in the "ON" position, the heater will turn on and off automatically when needed.

**CAUTION**  
To reduce the risk of SERIOUS INJURY:  
DO NOT touch the heater when switch is on, heater may be hot.

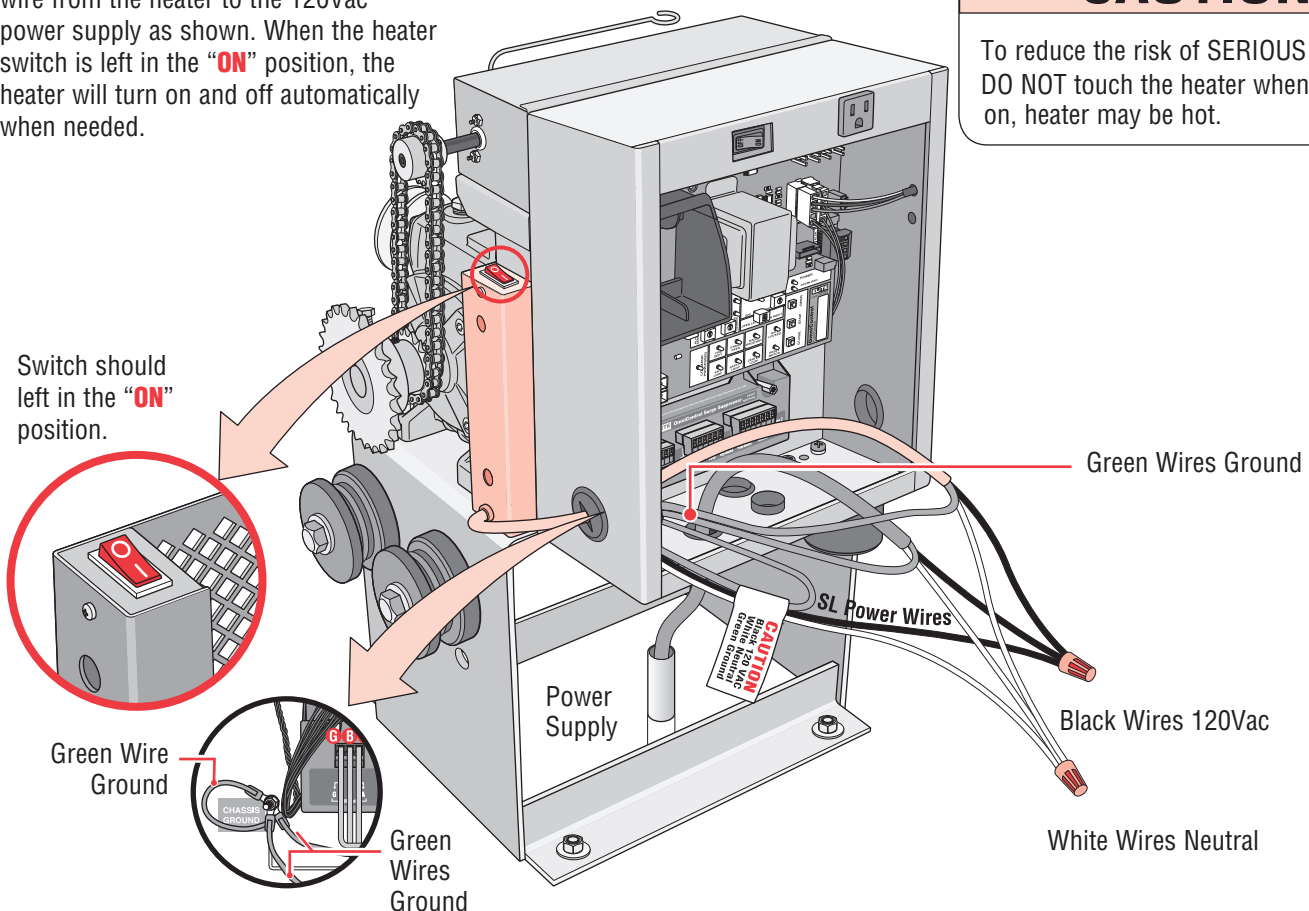

# LINKING MASTER/SECOND OPERATORS

Use a 20 amp dedicated power circuit for each operator.

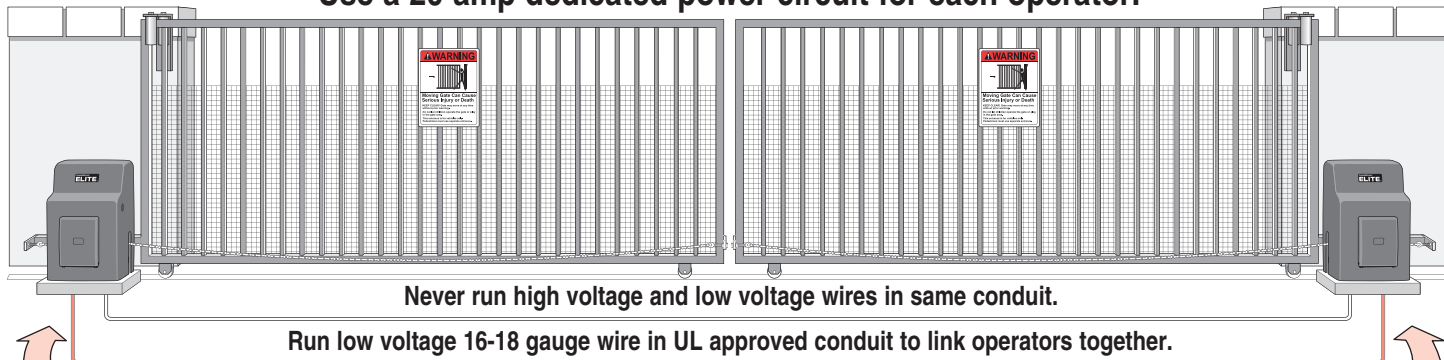

**Master Board**

Master/Second control boards are interchangeable.

**Second Board**

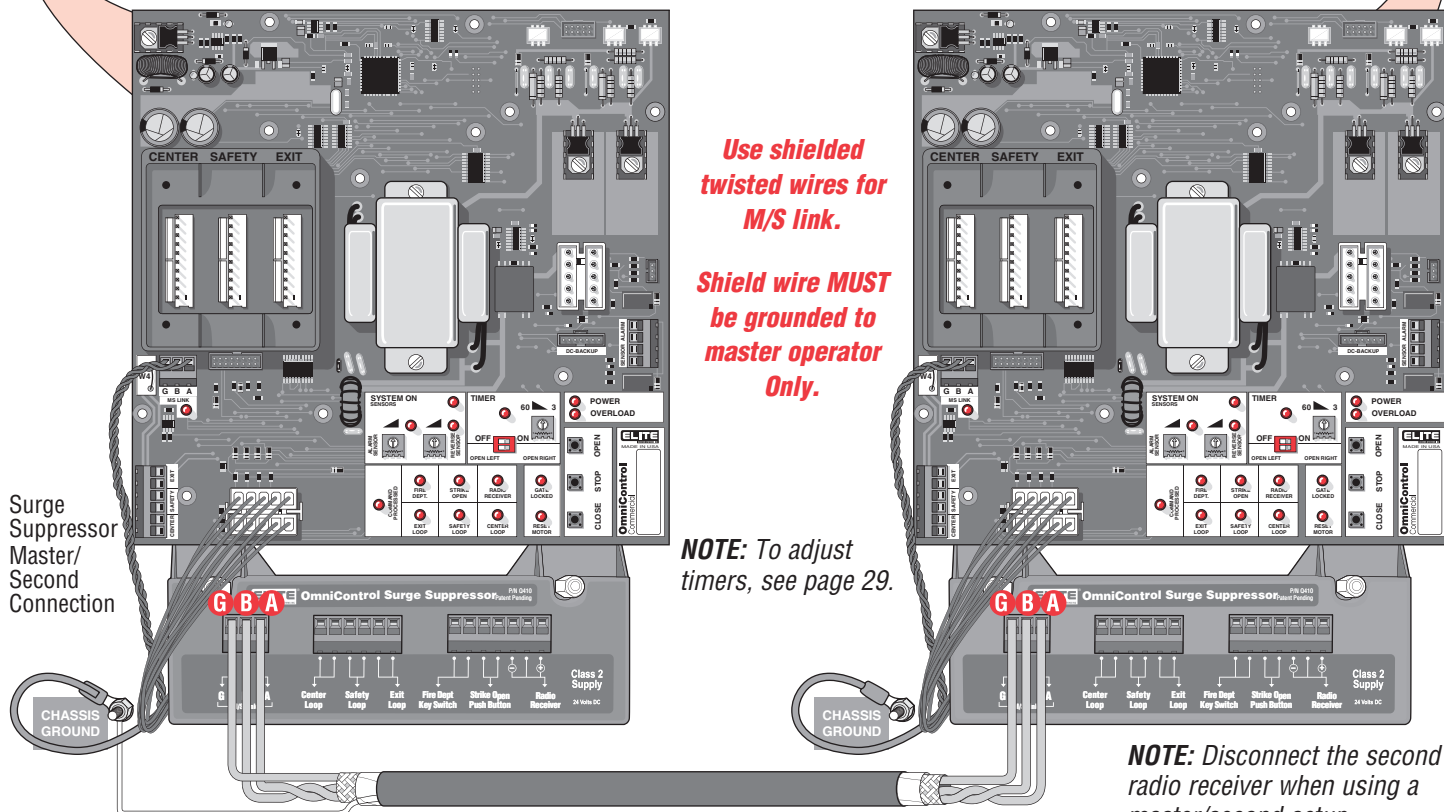

Use shielded twisted wires for M/S link.

Shield wire **MUST** be grounded to master operator **Only**.

**NOTE:** Disconnect the second radio receiver when using a master/second setup.

- Connect Master M/S Link G to Second M/S Link G.**
- Connect Master M/S Link B to Second M/S Link B.**
- Connect Master M/S Link A to Second M/S Link A.**

## Partial Master/Individual Control

In order for the following operation to occur, follow the instructions.

**EXAMPLE:** There is a double gate, the entry gate is to be opened with a radio transmitter and the exit gate with a free exit loop. Only one safety loop system is to open both gates, and a fire department switch should open both gates at the same time.

1. Connect the radio receiver to entry gate only.
2. Connect the exit loop to exit gate only.
3. Connect the safety loop to both entry and exit gates. Plug-in loop detectors not applicable (Observe polarity of voltage).
4. Connect the fire department switch to both entry and exit gates (Observe polarity of both operators).

# SOLENOID/MAGLOCK RELAY CONNECTION

Connection of a solenoid or magnetic lock can be made using the J7 board connector and "Optional" Relay Adapter Module. See Accessories.

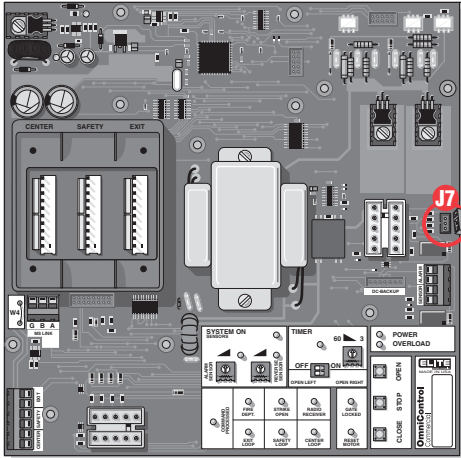

**Relay Contact Rating**  
**2 Amp - 125 AC/DC**  
**2 Amp switching load capability**

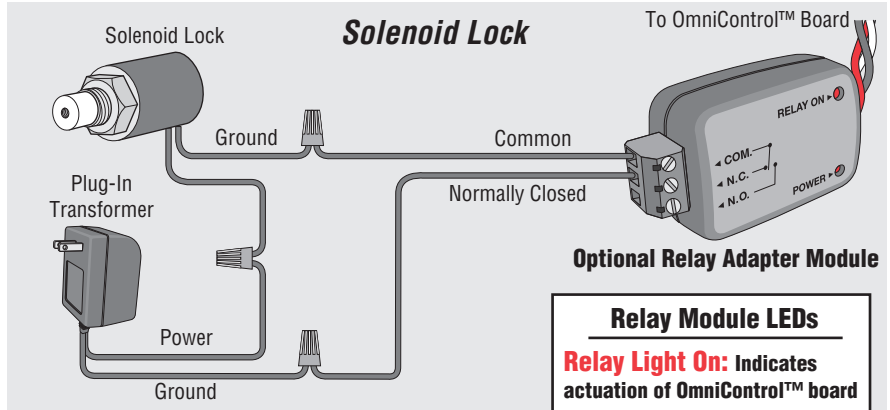

**Relay Module LEDs**  
**Relay Light On:** Indicates actuation of OmniControl™ board  
**Power Light On:** Indicates power is being received

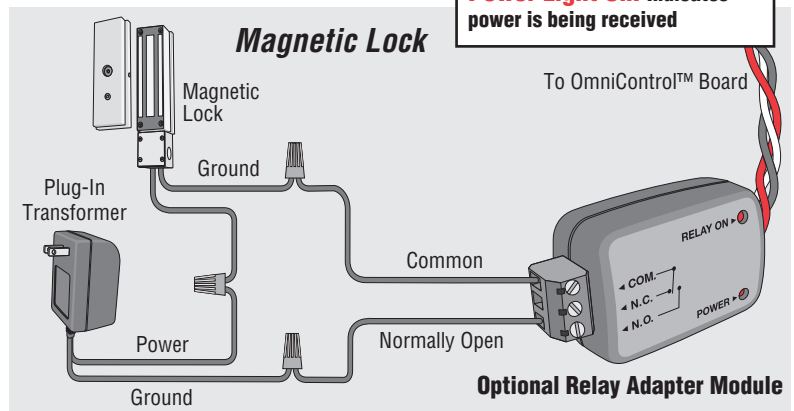

# FACTORY INSTALLED DC2000™ CONNECTION

## DC2000™ Startup

- 1 Plug in the 12 pin plug into the DC2000™ control unit. Make sure the “System ON” and “Charge OK” LEDs are lit. If the “Battery Low” led comes on, the battery needs to charge before it can be used.
- 2 Make sure “Gate Direction” setting on DC2000™ is set the same as the OmniControl™ board setting. See Adjustments.
- 3 Adjust “Reverse Sensor” setting. See Adjustment Reversing Sensor(s).

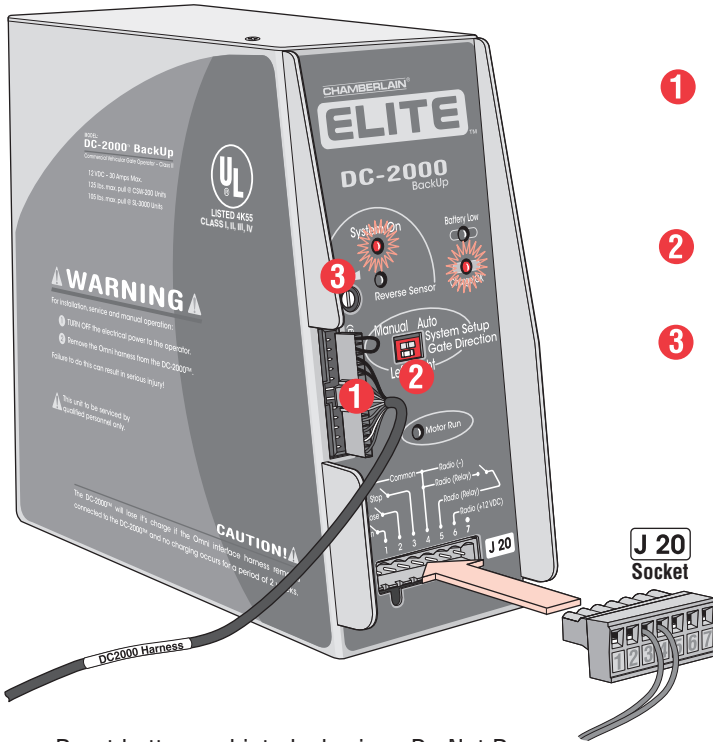

Reset button and interlock wires, Do Not Remove.

	120Vac Power Failure	120Vac Power On, OmniControl™ Board Malfunction
<b>Manual Mode</b>	Push and <b>Hold</b> to operate gate.	Turn the 120Vac power off then push and <b>Hold</b> to operate gate.
<b>Auto Mode</b>	Gate automatically opens.	Turn the 120Vac power off then gate opens automatically.

**NOTE:** All devices wired to the DC2000™ MUST be dedicated to it alone. Normal operation will be controlled by separate devices wired to the OmniControl™ board and surge suppressor.

**Typical Auto Mode Example:** If the DC2000 is “automatically opening” the gate due to a power failure (auto mode), any manual command such as “One-Button”, “Three Push Button”, “Key Switch”, “Photoelectric Sensor” or “Edge Sensor” will cancel the automatic mode of the DC2000™. After such cancellation, the DC2000™ will continue to operate in “manual mode” until 120Vac power is restored.

## DC2000™ 12Vdc Radio Receiver (Not Provided)

The DC2000™ needs a separate 12Vdc radio receiver to give remote commands to the operator during a power failure.

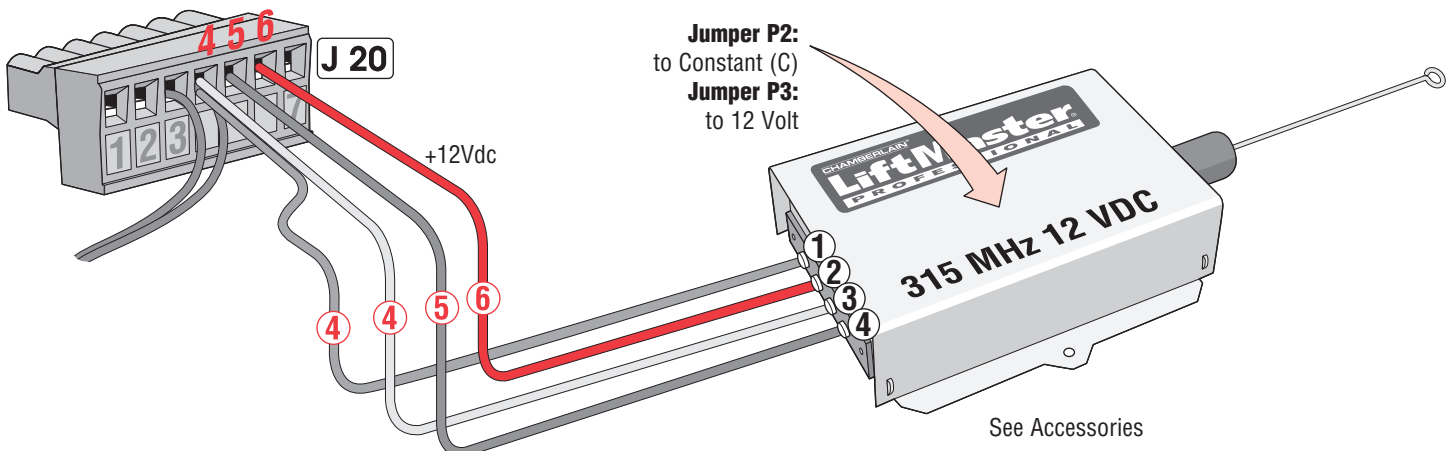

See Accessories

# DC2000™ DEVICE WIRING

## Manually Operated DC2000™ Devices

Manual external devices should be dry-contact which do not consume any current like push buttons or a key switch.

**Key switch is for property owner's emergency access ONLY. DO NOT FOR USE FOR A EMERGENCY FIRE/POLICE KEY ACCESS.**  
Contact your local Fire/Police municipalities for more information on correct Fire/Police emergency key access.

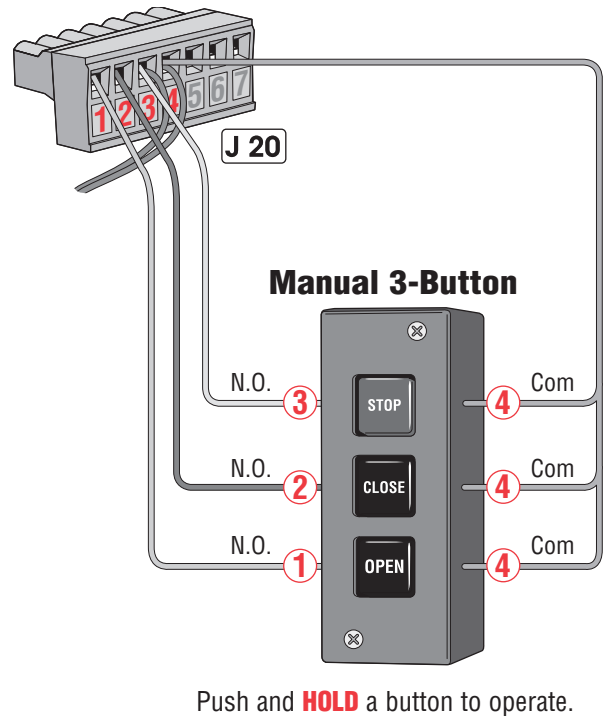
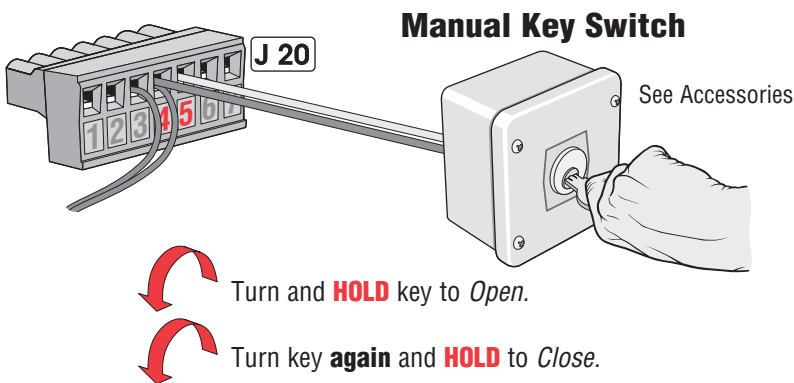
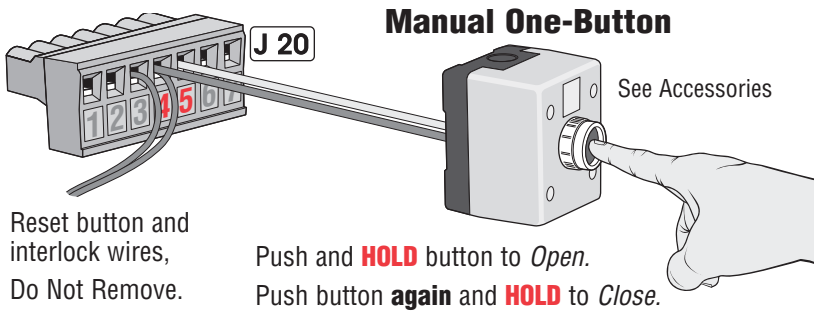

## DC2000™ Entrapment Protection Devices

It is recommended using separate entrapment protection devices to maintain gate safety when the DC2000™ is needed for any reason. The entrapment protection devices connected to the OmniControl™ board and surge suppressor **WILL NOT** protect the gate when there is a AC power failure and the DC2000™ is used.

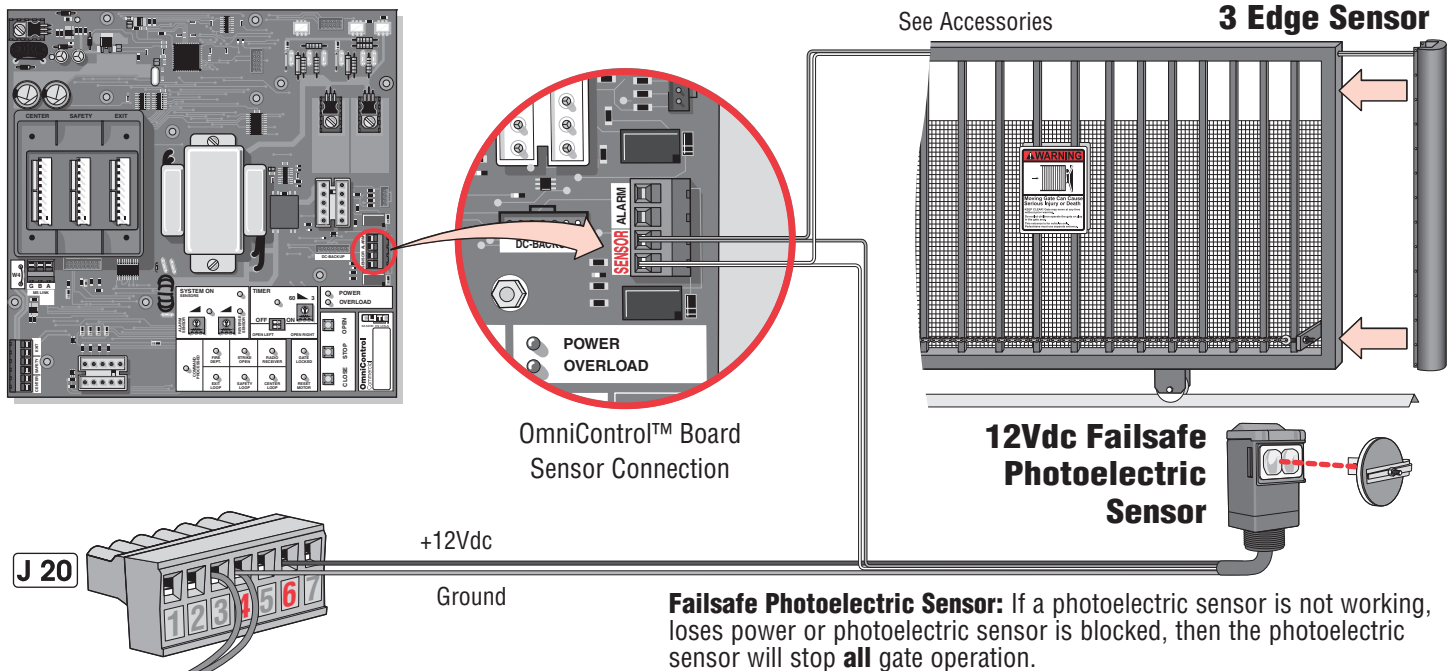

# PLUG-IN LOOP DETECTOR WIRING

Plug-In Loop Detectors  
See Accessories

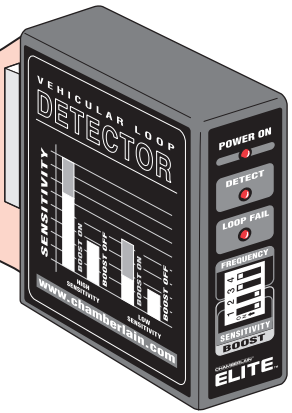
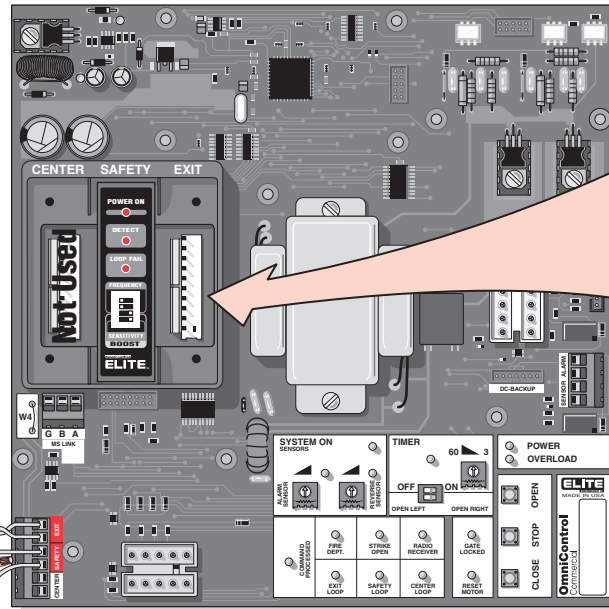

The wire **MUST** be twisted together **minimum 6 twists per foot** from the end of the loop to the control board.

Series Connected

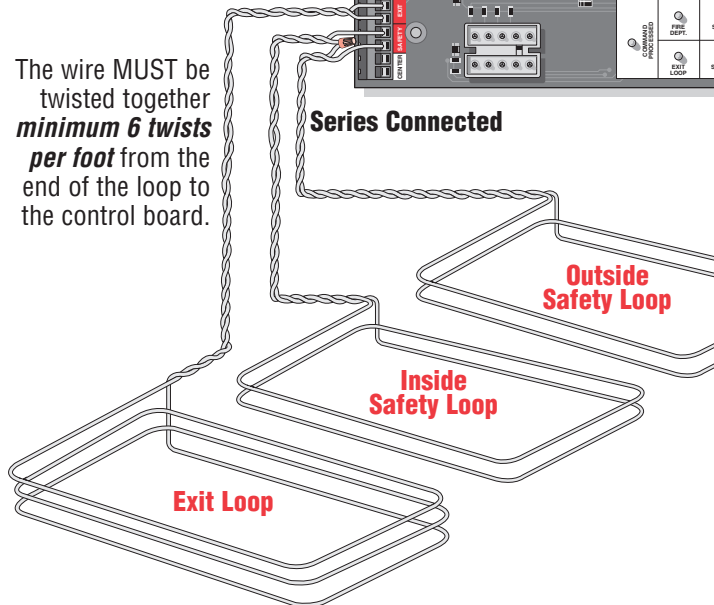

## CAUTION

To **AVOID** damaging control board, disconnect **ALL** power to operator before installing plug-in loop detectors.

Use a different frequency for every loop detector installed.

**NOTE:** Refer to the plug-in loop detector manual for more specific information.

**Plug-In “Safety” Loop Detector** - Allows gate to stay open when vehicles are obstructing path. Caution: Suggested for vehicles 14 feet or longer. If the “**Inside**” and “**Outside**” safety loops are connected to the same loop detector:

- They should be series connected to the detector.
- Have the same dimensions.
- Have the same number of wire turns.

Example of a inside and outside 2 wire turn loop connected in series. (See “Installing Insulated Loop Wire” on next page for more information)

**Plug-In “Exit” Loop Detector** - Allows gate to automatically open for exiting vehicles.

Example of a 3 wire turn loop. (See “Installing Insulated Loop Wire” on next page for more information)

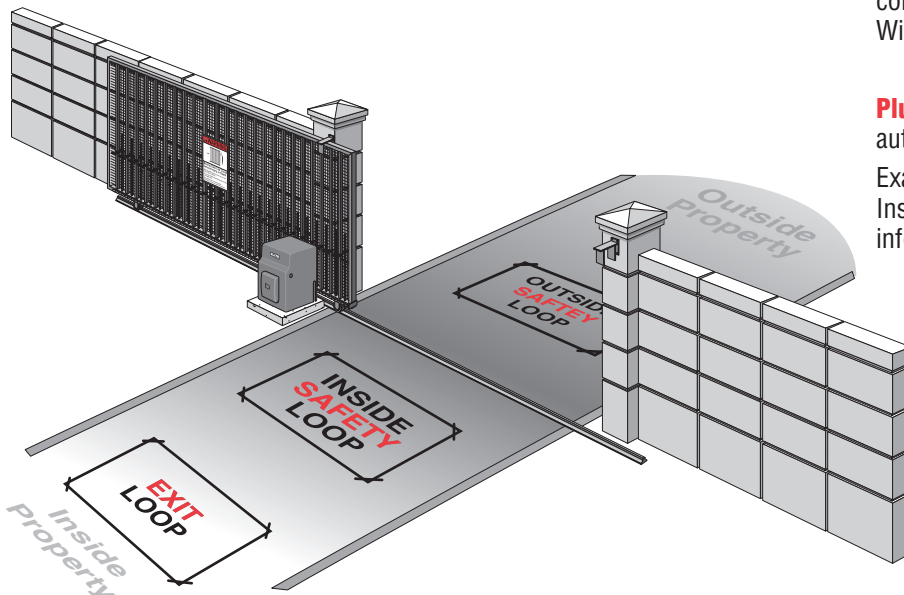

**Contact your local dealer for information about plug-in loop detectors.**

# 120VAC EXTERNAL LOOP DETECTOR WIRING

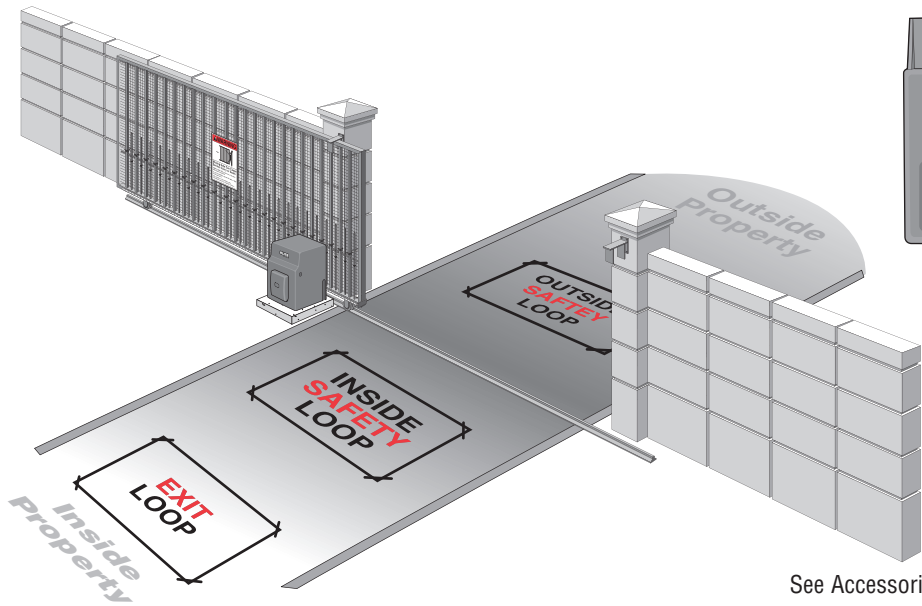

See Accessories

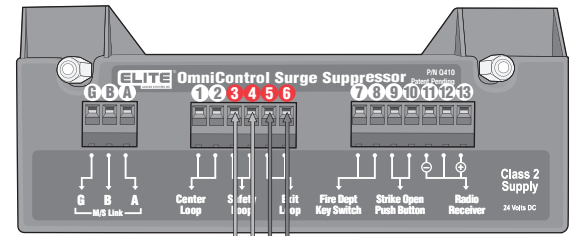

**120Vac "Safety" Loop Detector** - Allows gate to stay open when vehicles are obstructing path.

**CAUTION:** Suggested for vehicles 14 feet or longer. If a vehicle is shorter, a center loop system is recommended and should be installed.

If the "Inside" and "Outside" safety loops are connected to the same loop detector:

- They should be series connected to the detector
- Have the same dimensions.
- Have the same number of wire turns (See table below).

**120Vac "Exit" Loop Detector** - Allows gate to automatically open for exiting vehicles.

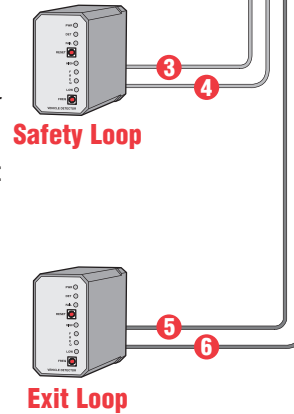

## Installing Insulated Loop Wire

Number of Wire Turns Needed for Loop Sizes

Loop Perimeter	Number of Wire Turns
10 feet to 13 feet	4
14 feet to 26 feet	3
27 feet to 80 feet	2
80 feet and up	1

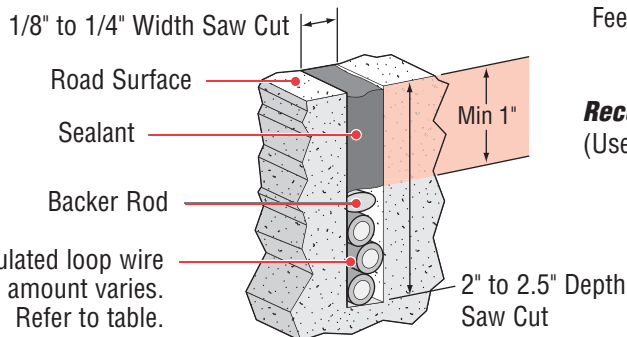
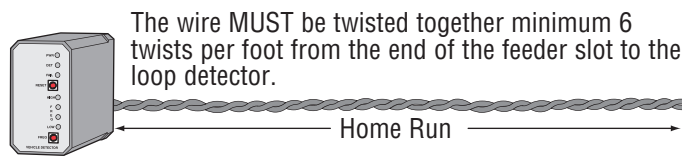
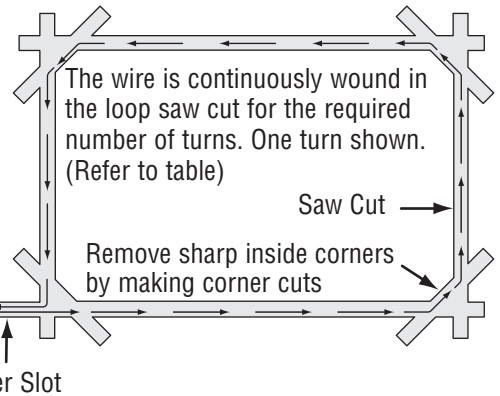

Contact your local dealer for more information about loop detectors.

**Recommended Loop Wire XLPE 12-18 gauge**  
(Use heavier wire gauge for a more durable loop).

**NOTE:** Wire mesh or reinforcement embedded in the road surface should be cut away a minimum of 6 inches from the perimeter of the loop.



# ENTRAPMENT PROTECTION DEVICES

## Contact Sensors (Edge Sensor)

### WARNING

To prevent SERIOUS INJURY or DEATH from a moving gate:

- Locate entrapment protection devices to protect in BOTH the open and close gate cycles.
- Locate entrapment protection devices to protect between moving gate and RIGID objects, such as posts or walls.

**NOTE:** When touched, these electrically activated edge sensors immediately signal the gate operator to stop and reverse. Property owners are obligated to test edges monthly. See Accessories.

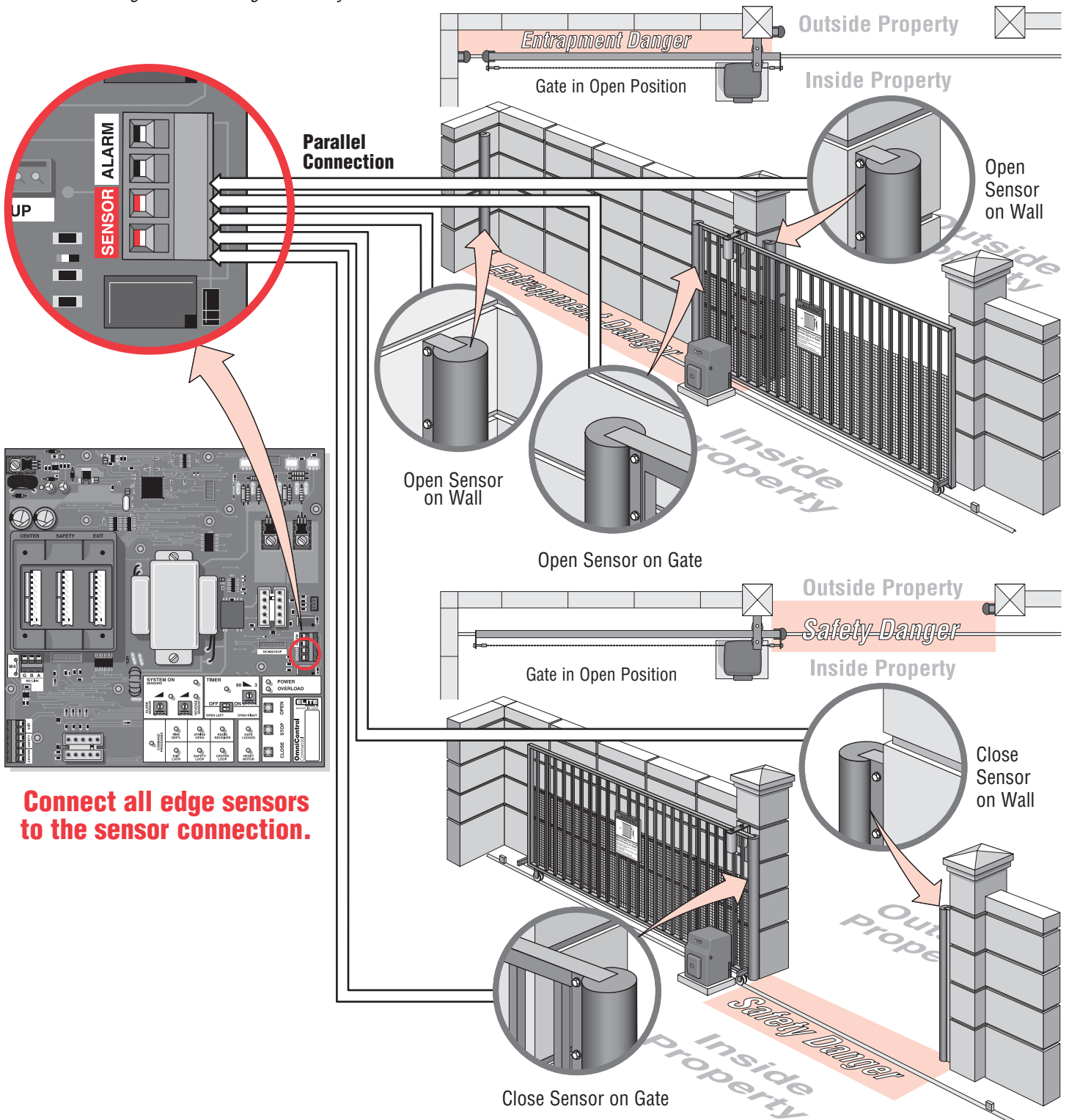

# ENTRAPMENT PROTECTION DEVICES

## Non-Contact Sensors (12Vdc Photoelectric Sensors)

**NOTE:** Property owners are obligated to test photoelectric sensors monthly.

### Entrapment Non-Contact Sensor

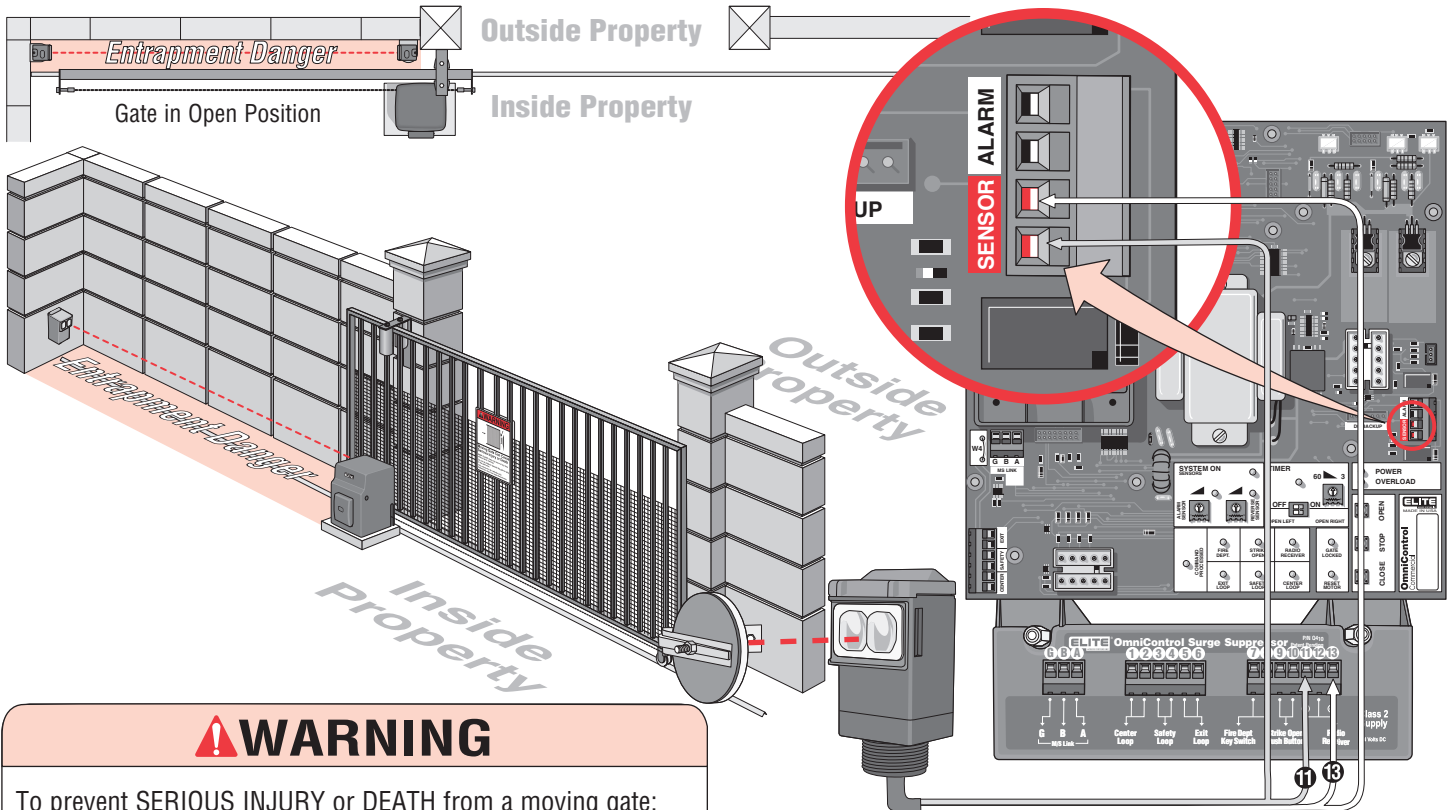

### ⚠️ WARNING

To prevent **SERIOUS INJURY** or **DEATH** from a moving gate:

- Locate entrapment protection devices to protect in **BOTH** the open and close gate cycles.
- Locate entrapment protection devices to protect between moving gate and **RIGID** objects, such as posts or walls.

**NOTE:** If the photoelectric beam gets blocked while the gate is closing, it will stop and reopen. The gate will remain open until the obstruction is cleared.

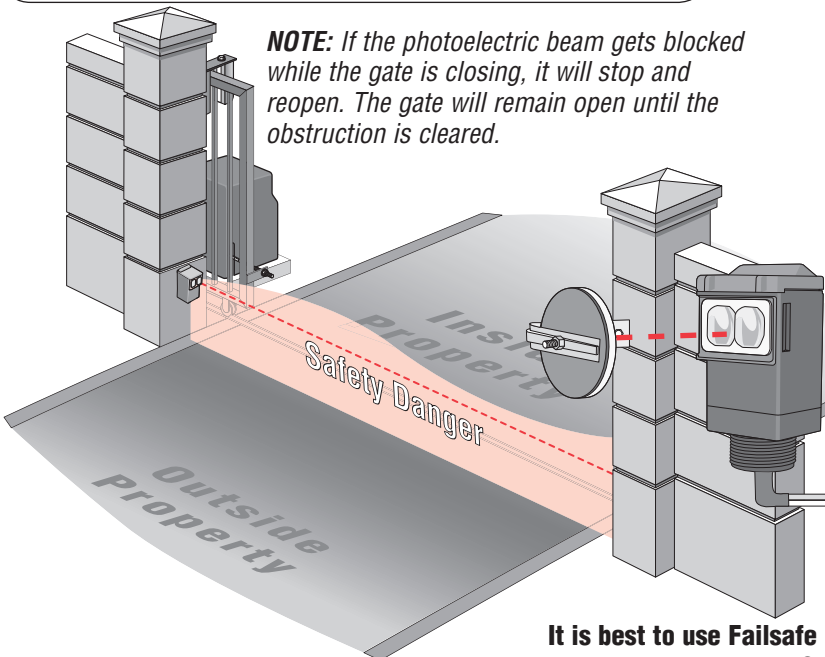

### Safety Non-Contact Sensor

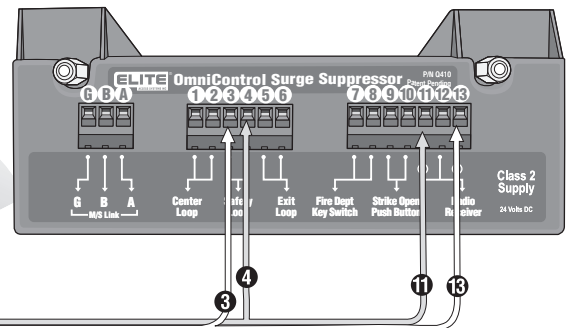

**It is best to use Failsafe Photoelectric Sensors for this Safety Option.**

**Failsafe Photoelectric Sensors:** If a failsafe photoelectric sensor is not working or loses power or photoelectric beam is blocked, then the photoelectric beam will stop ALL gate operation.

Contact your local dealer for more information about photoelectric sensors.

# OMNI OPTION BOARD CONNECTIONS

**NOTE:** Refer to the Omni Option Board manual for more specific information.

Purchased separately from Chamberlain Elite. See Accessories.

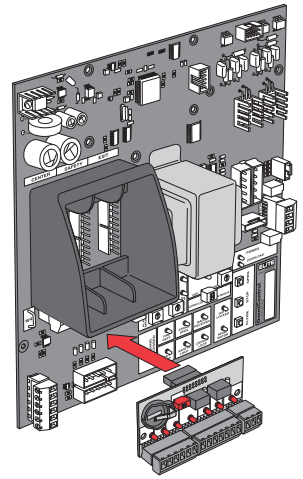
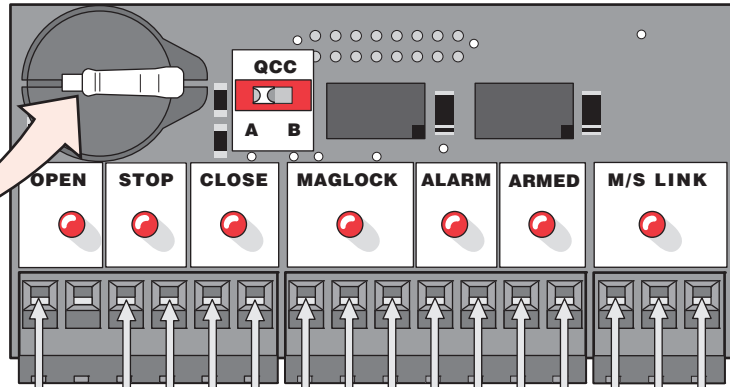

## Quick Close Circuit

Allows the gate's close cycle to close quicker than the OmniControl™ timer will allow. Refer to the QCC manual for more specific information. See Accessories.

**Second Operator**



**Proximity Switch**

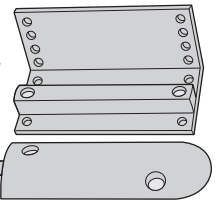

**12Vdc House Alarm**

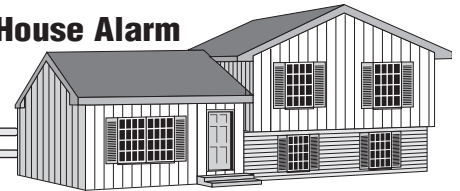

**Maglock**

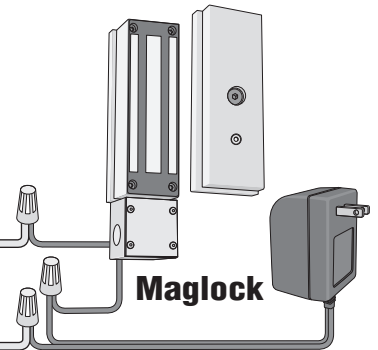

**Solenoid Lock**

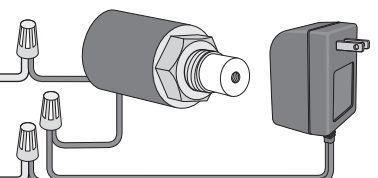

**Relay Contact Rating**  
0.5 Amp - 125Vac  
1 Amp - 24Vdc

## 3 Button Station

Dry Contact

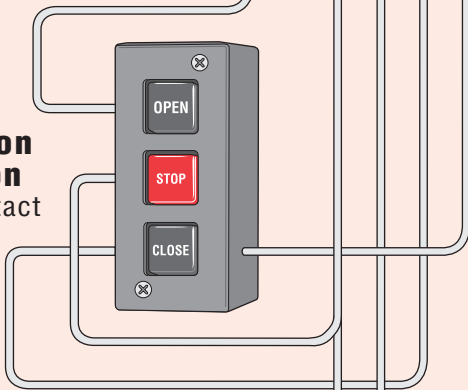

**Stop Button**  
Dry Contact

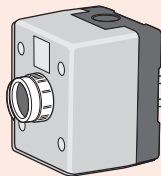

**NOTE:** Cut jumper W4 wire ONLY when installing a 3 button station, stop button, or QCC.

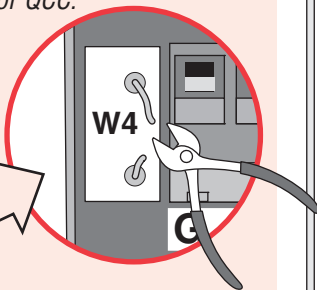
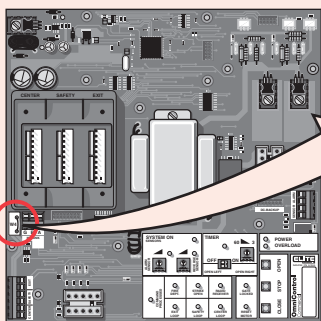

# Adjustments

## ⚠️ WARNING

To reduce the risk of **SERIOUS INJURY** or **DEATH**:  
Disconnect electric power **BEFORE** performing **ANY** adjustments.

## SET GATE OPENING DIRECTION

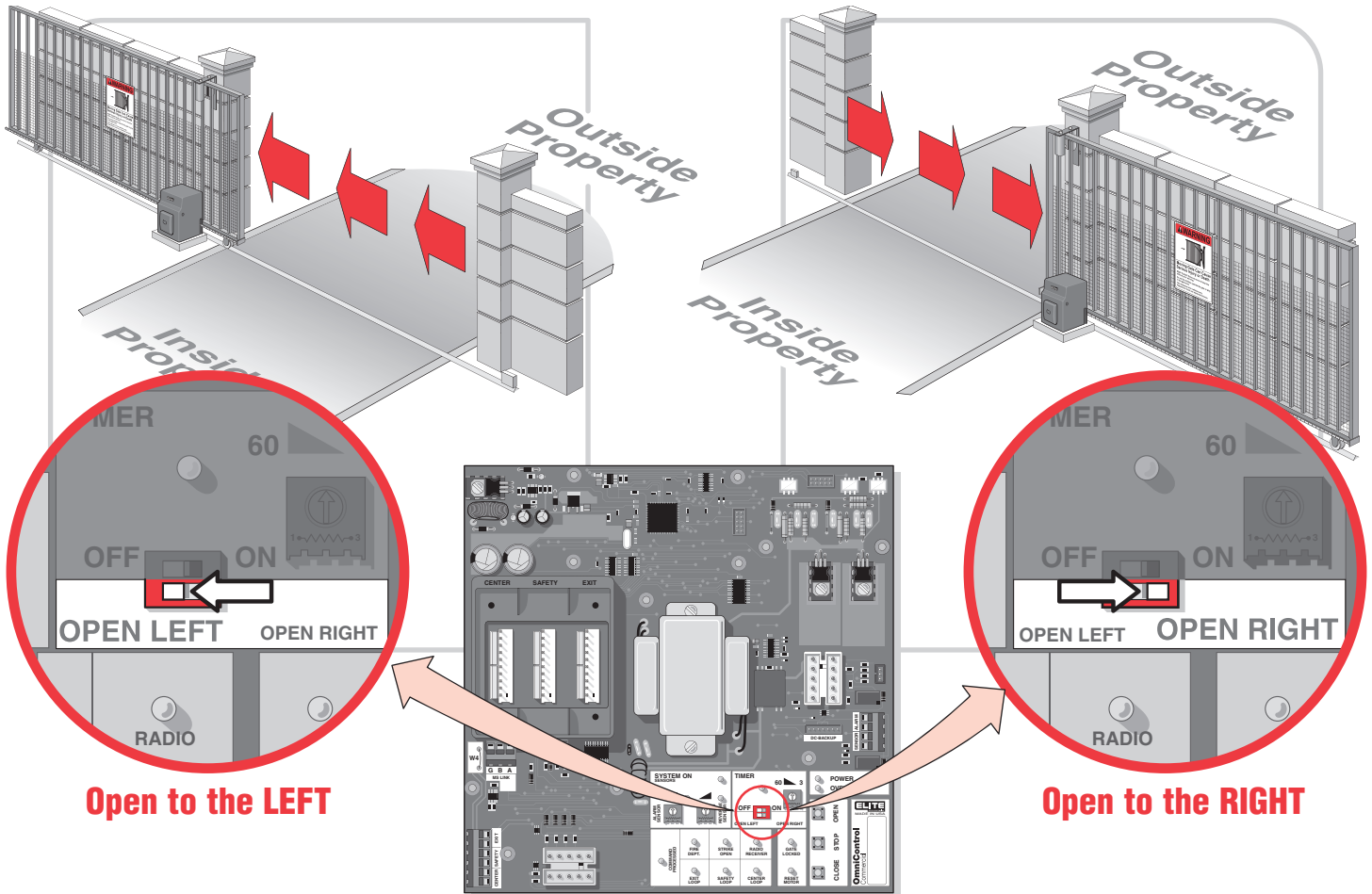

## LIMIT SWITCH ADJUSTMENTS

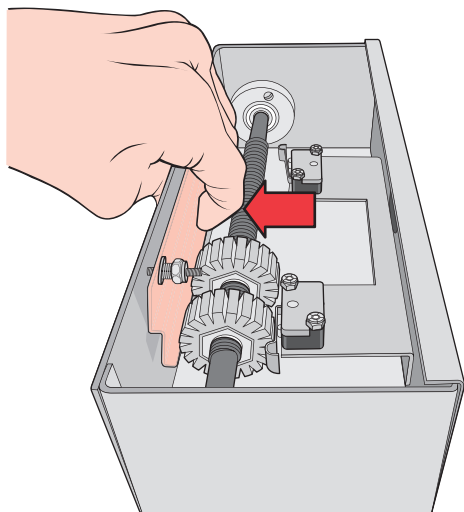

Push and **hold** lock plate to release limit nuts.

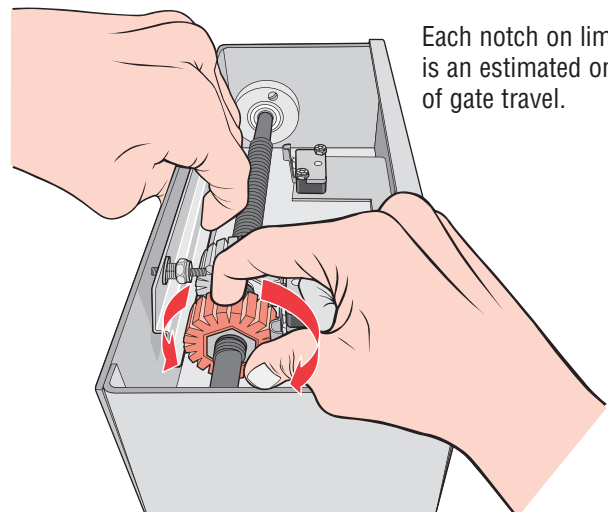

Each notch on limit nut is an estimated one inch of gate travel.

Roll limit nuts to adjust the open and close limit switches.

# 315 MHZ 24VDC RADIO RECEIVER PROGRAMMING

## Setting Security Mode (High) or (Normal):

The receiver is factory set at **HIGH** security mode. To verify, refer to the label next to jumper P4 (See illustration below).

The Receiver can be used with up to **15 rolling code remotes or pins in HIGH security mode**. Alternately, it can be used with up to **31 of any type remote in NORMAL security mode**, including any combination of rolling code, billion code, or dip switch remotes.

When changing from **NORMAL** to **HIGH** security mode, *all previous remote control codes must be erased*. See next page to erase and reprogram remote controls that are being used.

**⚠️ WARNING**

To prevent possible **SERIOUS INJURY** or **DEATH** from a moving gate or garage door:

- ALWAYS keep remote controls out of reach of children. NEVER permit children to operate, or play with remote control transmitters.
- Activate gate or door **ONLY** when it can be seen clearly, is properly adjusted, and there are no obstructions to door travel.
- ALWAYS keep gate or garage door in sight until completely closed. NEVER permit anyone to cross path of moving gate or door.

**CAUTION**

To **AVOID** damaging receiver, disconnect receiver's power **BEFORE** changing jumpers.

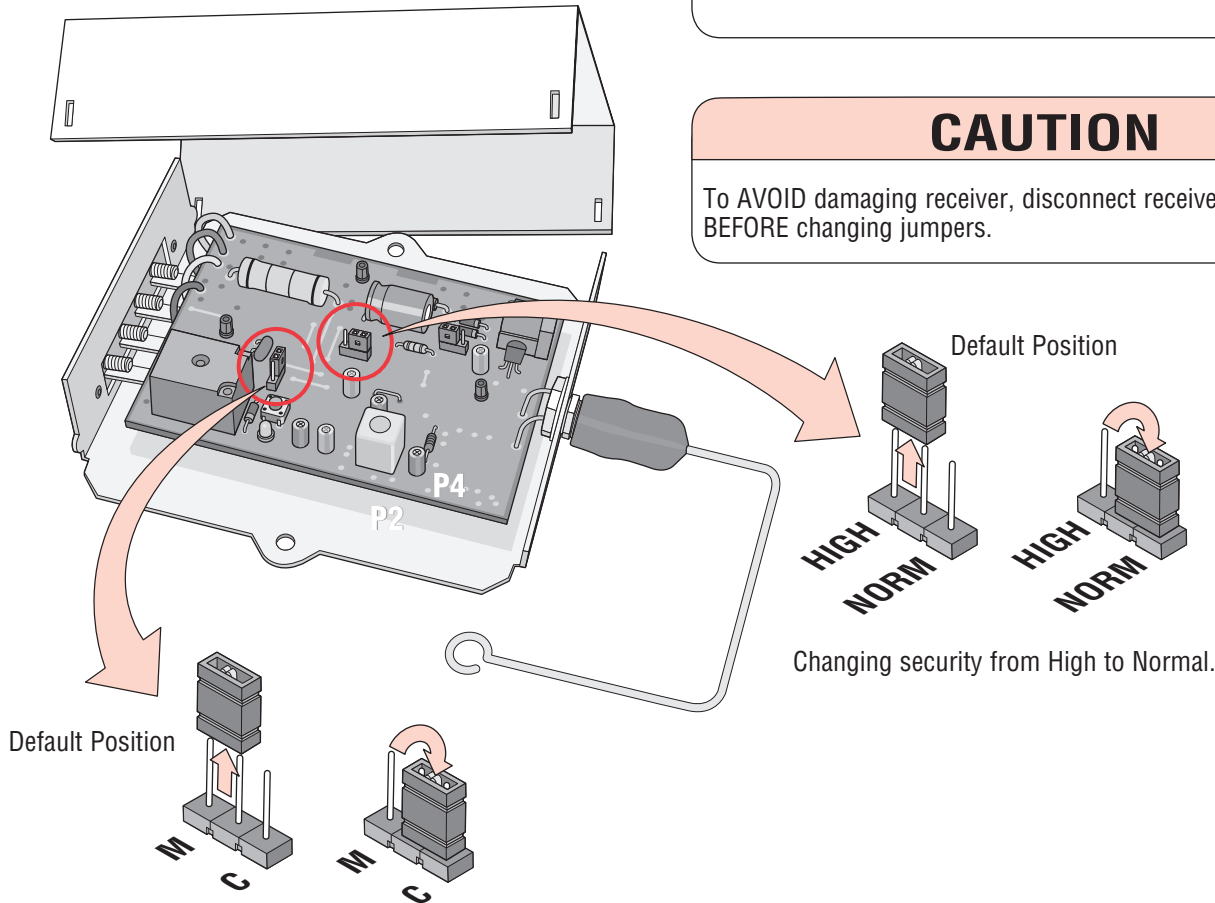

Changing output duration from Momentary to Constant.

## Setting Output Duration (M) or (C):

The receiver is factory set at **(M)** Momentary. To verify, refer to the label next to jumper P2. (See illustration above)

For commercial applications, the receiver can be set to either **(C)** constant or **(M)** momentary closure.

With the jumper in the **(M)** momentary position, the *contacts will close for 1/4 second regardless of the length of remote control transmission*.

With the jumper in **(C)** constant position, the *contacts will stay closed as long as the remote control continues transmitting*.

Push and **HOLD** remote button to open or close gate.

**⚠️ WARNING**

To reduce the risk of **SERIOUS INJURY** or **DEATH**, the use of **CONSTANT OPERATION** on residential operators is **PROHIBITED**.

# 315 MHZ 24VDC RADIO RECEIVER PROGRAMMING

**IMPORTANT:** Hand-held remote **NOT** included.

**NOTICE:** To comply with FCC and or Industry Canada (IC) rules, adjustment or modifications of this receiver and/or transmitter are prohibited, except for changing the code setting or replacing the battery. THERE ARE NO OTHER USER SERVICEABLE PARTS. Tested to Comply with FCC Standards FOR HOME OR OFFICE USE. Operation is subject to the following two conditions: (1) this device may not cause harmful interference, and (2) this device must accept any interference received, including interference that may cause undesired operation.

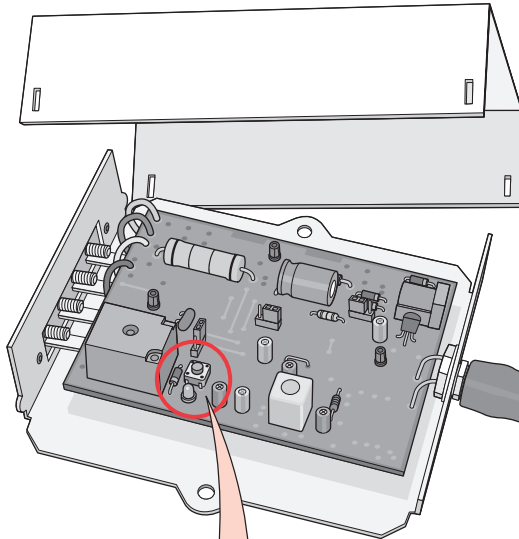

**NOTE:** Receiver wiring on Surge Suppressor Terminal Connections page.

Disconnect the second receiver when using a master/second setup.

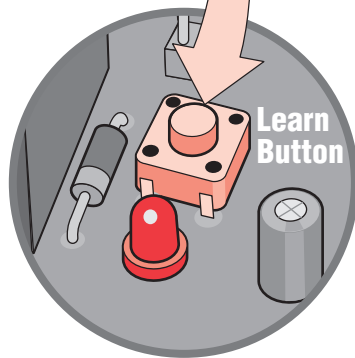
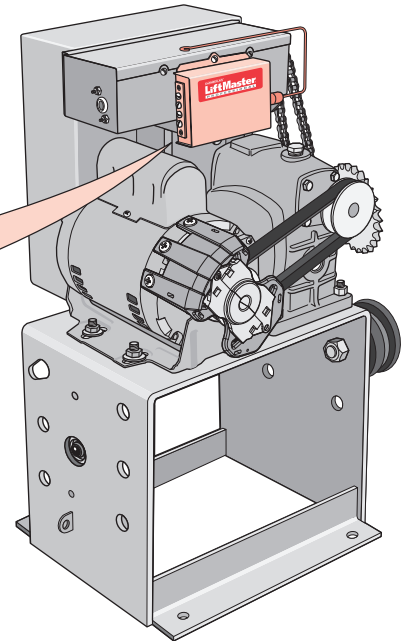

## **Programming Radio Receiver:**

1. Press and release the "**Learn**" button on the receiver. The learn indicator light will glow steadily for 30 seconds.
2. Within 30 seconds, press and hold the button on the hand-held remote. The operator will now operate when the push button on the remote control is pressed. Repeat Steps 1 and 2 for each remote control that will be used.

## **Erase ALL Remote Control Codes:**

Press and hold the "**Learn**" button on the receiver panel until the indicator light turns off (about 6 seconds). All previous codes are now erased. Reprogram each remote you wish to use.

**Optional 315 MHz Hand Held Remotes - See Accessories**

# SETTING TIMER (ON, OFF)

## Single Operator

To use the automatic close for the gate system the timer switch should be put in the "ON" position.

To use the push close command, the timer should be switched to the "OFF" position. Push button once to open gate, push button again to close gate.

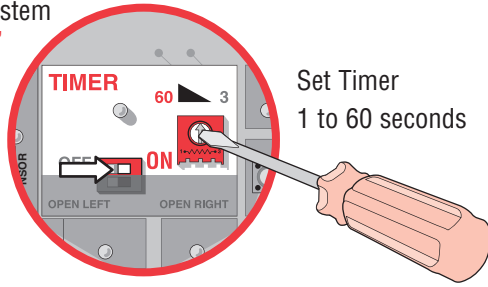

Set Timer  
1 to 60 seconds

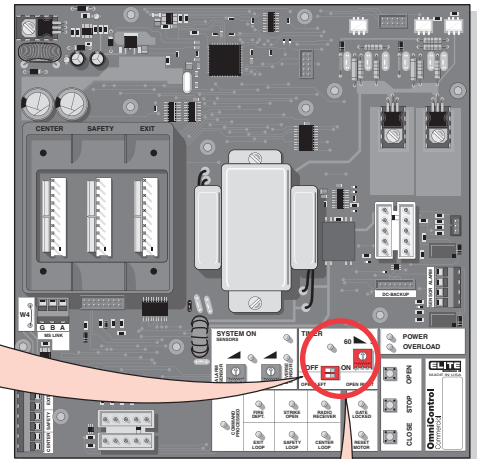
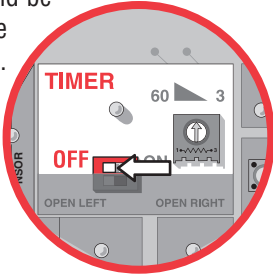

## Master/Second Operators

Operators need to be connected by **M/S LINK**. See M/S Link.

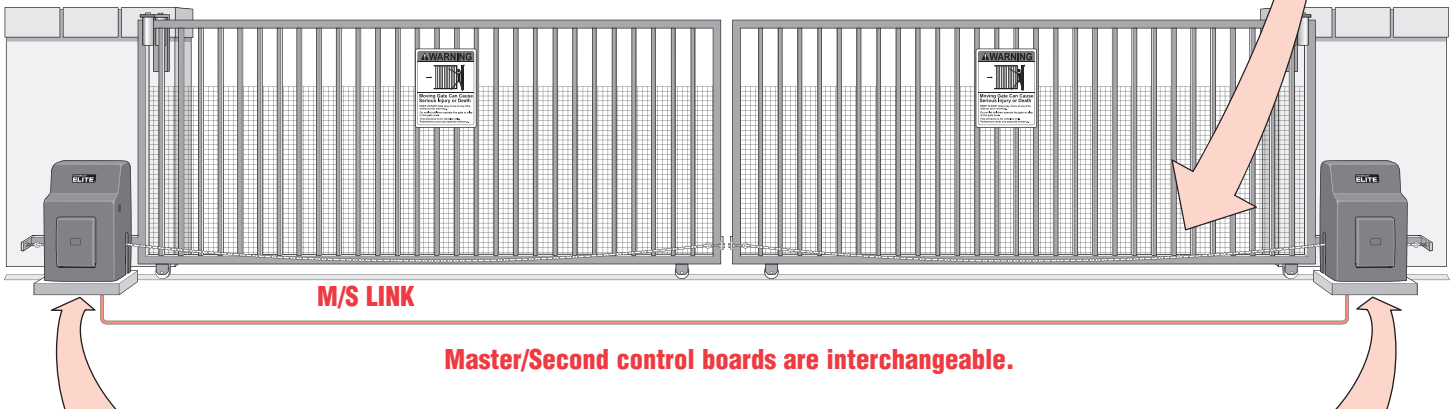

### Master Board

### with Timers ON

### Second Board

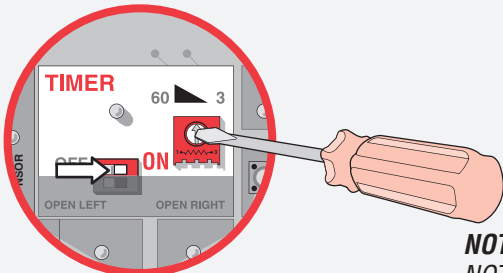

1. Turn Master Timer ON.
2. Turn Second Timer OFF.

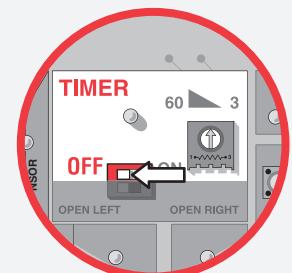

3. Use Timer on Master Board Only.  
(1 to 60 seconds)

**NOTE:** If a secondary safety sensor device is NOT used when the timer is ON, the gate WILL hit a vehicle obstructing the gate path before reversing during the close cycle.

### Master Board

### with Timers OFF

### Second Board

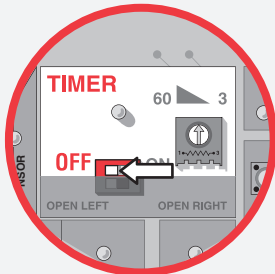

1. Turn BOTH timers OFF.

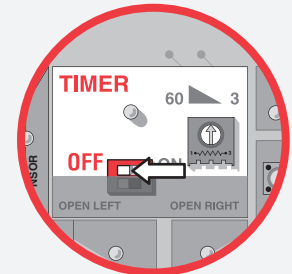

**NOTE:** Push button once to open gate, push button again to close gate.

# ADJUSTING REVERSING SENSOR(S)

Adjust the “**Reverse Sensor**” on the control board. **Alarm Sensor** does not need to be adjusted except where noted below.

**The level of reverse sensitivity depends on the weight of the gate and the condition of installation.**

**Sensor is set too sensitive** = if the gate stops in midcycle or reverses by itself.

**Sensor is not set sensitive enough** = if the gate hits an object and does not stop or reverse.

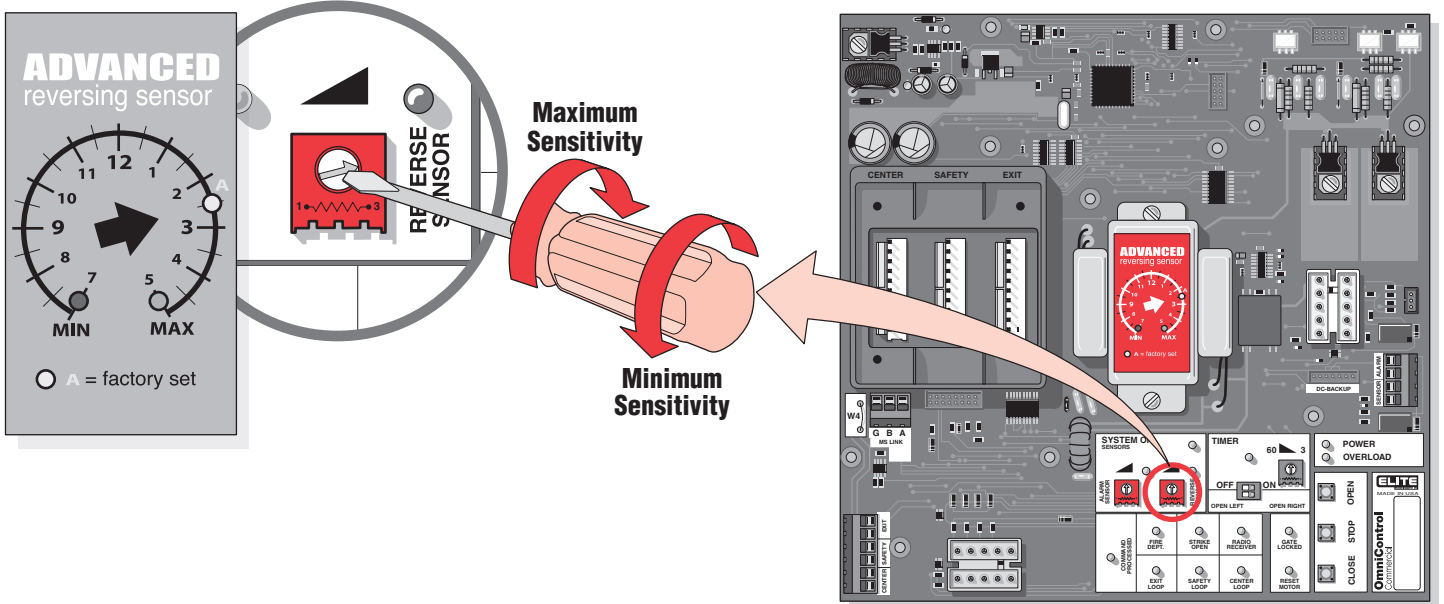
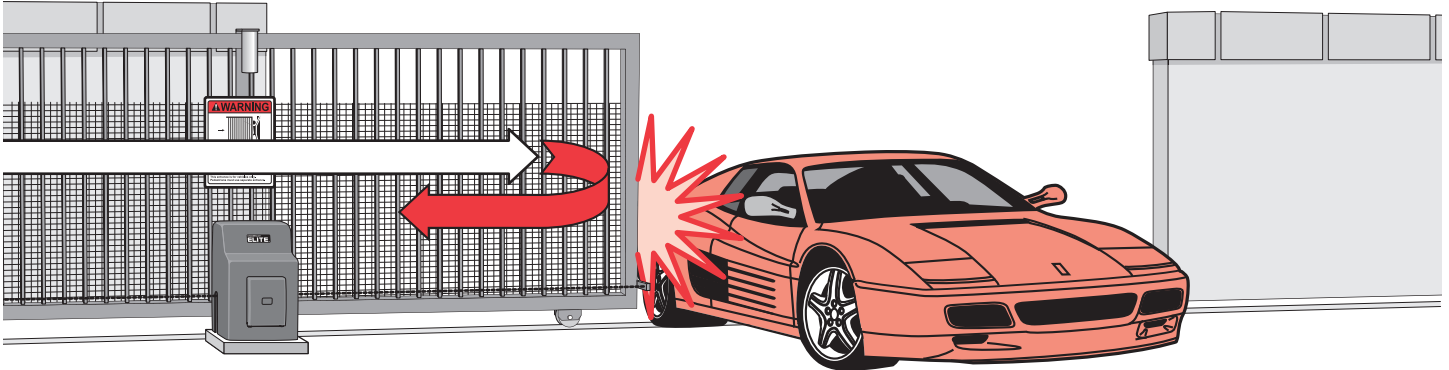

## DC2000™ Reverse Sensor

The DC2000™ has a separate reverse sensor that will need to be adjusted. The 120Vac operator power needs to be turned off and the DC2000™ should have the “**Charge OK**” LED **ON** to make the adjustment.

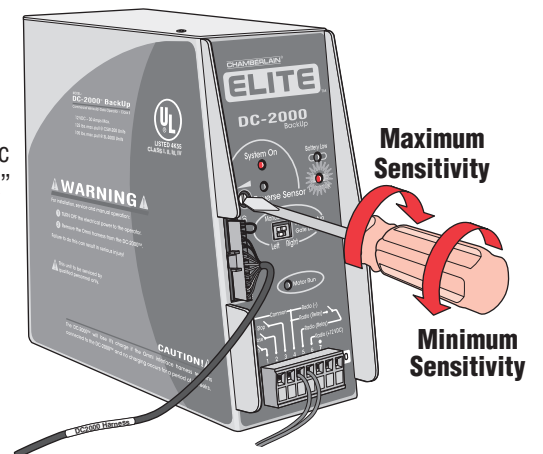



## IMPORTANT SAFETY INSTRUCTIONS

### WARNING

#### To reduce the risk of SEVERE INJURY or DEATH:

1. READ AND FOLLOW ALL INSTRUCTIONS.
2. NEVER let children operate or play with gate controls. Keep the remote control away from children.
3. ALWAYS keep people and objects away from the gate. NO ONE SHOULD CROSS THE PATH OF THE MOVING GATE.
4. Test the gate operator monthly. The gate MUST reverse on contact with a rigid object or stop when an object activates the non-contact sensors. After adjusting the force or the limit of travel, retest the gate operator. Failure to adjust and retest the gate operator properly can increase the risk of INJURY or DEATH.
5. Use the emergency release ONLY when the gate is NOT moving.
6. KEEP GATES PROPERLY MAINTAINED. Read the owner's manual. Have a qualified service person make repairs to gate hardware.
7. The entrance is for vehicles ONLY. Pedestrians MUST use separate entrance.
8. Disconnect ALL power BEFORE performing ANY maintenance.
9. ALL maintenance MUST be performed by a Chamberlain Elite professional.
10. **SAVE THESE INSTRUCTIONS.**

## MAINTENANCE:

1. Disconnect power before servicing.
2. The gate area should be kept clean to insure proper operation.
3. Check for belt tightness.
4. Check chain for tightness. Refer to chain distance and height page.
5. Make sure the reversing sensor is functioning properly. Check it monthly (Page 30).
6. Make sure the gate track is clear of dirt, rocks or other substances.
7. Make sure the wheels are operating smoothly on the track.
8. Oil the chain regularly with a chain lubrication oil available at most motorcycle stores.
9. Check for proper synthetic oil level in the gear box (10W-30 weight synthetic oil).
10. Severe or high cycle usage will require more frequent maintenance checks.
11. Inspection and service should always be performed anytime a malfunction is observed or suspected.
12. When servicing, please do some "house cleaning" of the operator and the area around the operator. Pick up any debris in the area. Clean the operator as needed.
13. It is suggested that while at the site voltage readings be taken at the operator. Using a Digital Voltmeter, verify that the incoming voltage to the operator it is within ten percent of the operators rating.
14. Verify all safety and entrapment devices are functioning.

## BUILT-IN RESET SWITCH

When the gate operator's audio alarm has been tripped (see below), the reset switch must be pushed for the operator to function again.

The reset switch will shut off an activated audio alarm and reset the operator to function again.

*If the audio alarm goes off, always check the gate area for:*

- **Obstructions in the gate path.**
- **Damage to the gate and/or gate operator.**

**Pressing the reset switch will stop a moving gate during a normal open/close cycle, like a stop button. The operator does **NOT** need to be reset after doing this.**

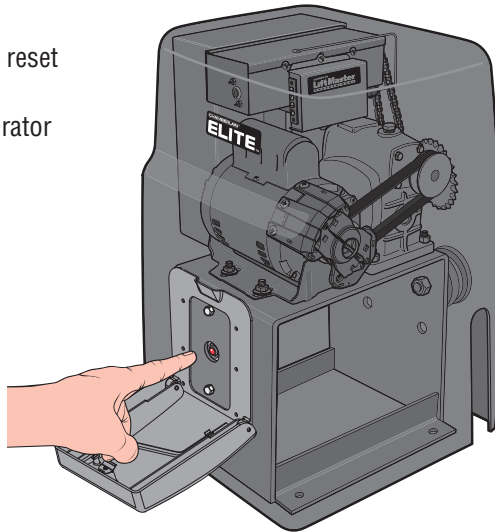

## AUDIO ALARM

The alarm could be tripped when one of the following happens **twice consecutively**, then the alarm will sound for **5 minutes** or until the reset switch is pressed!

**Press the built-in reset switch to shut off alarm and reset operator (see above).**

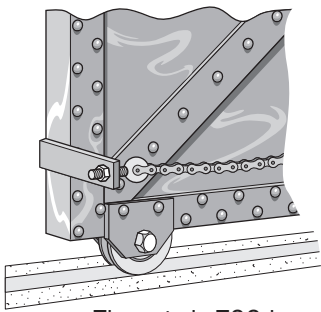

The gate is TOO heavy.

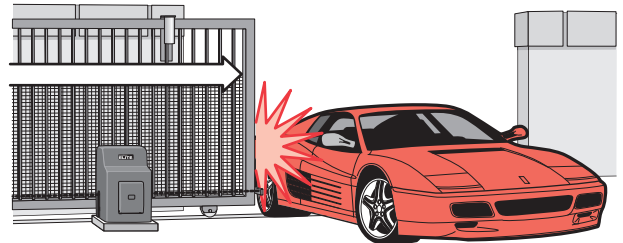

The gate is hitting a wall or vehicle.

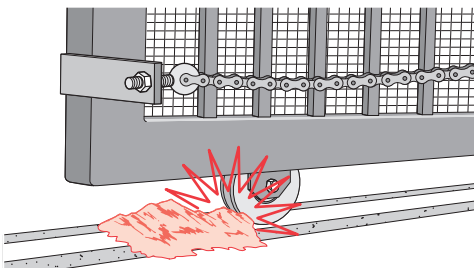

Debris is on the gate's track such as mud, rocks, dirt, etc.

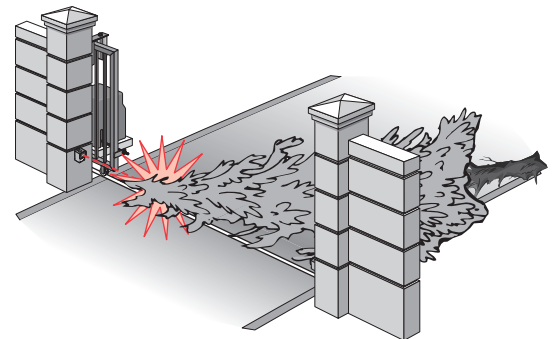

An externally wired entrapment protection device has been triggered twice (Photoelectric sensor blocked).

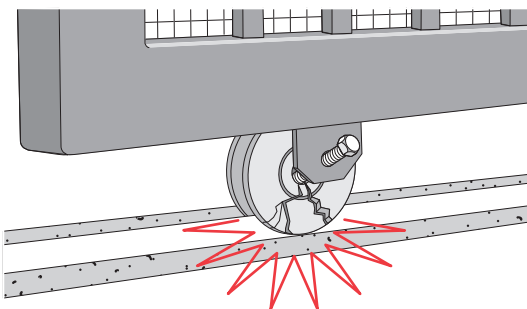

The gate has one or more broken axles or wheels.

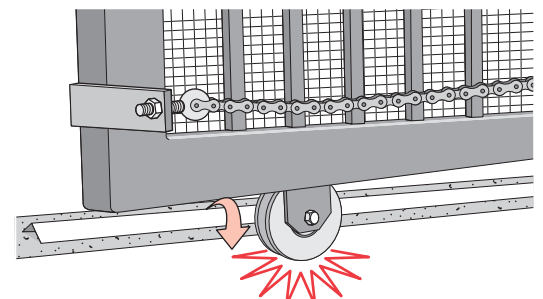

The gate wheel is off the gate rail.

## EMERGENCY MANUAL RELEASE

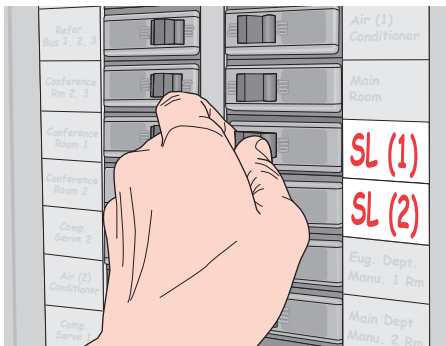

**Turn the power OFF!**

**NOTE:** Use the dedicated breaker switch to disconnect power to the operator.

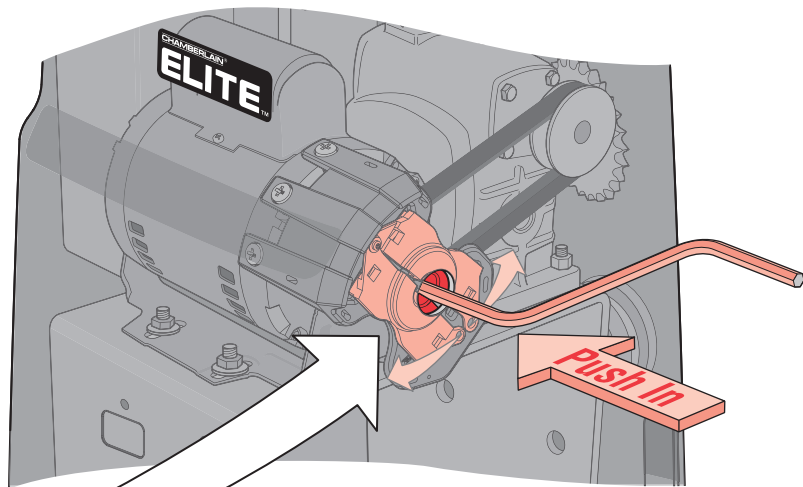

Push the crank tool in hole. Safety releases will separate. Turn the crank to open the gate.

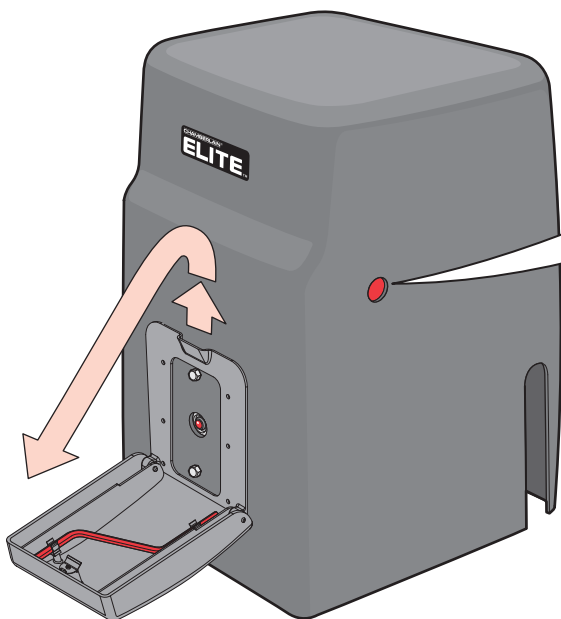

Remove crank tool.

**NOTE:** YOU may use a cordless power drill (6"/sec) for quicker opening in non-emergency situations.

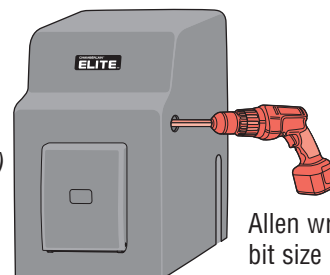

Allen wrench drill bit size is 5/16"

## OPTIONAL MANUAL RELEASE

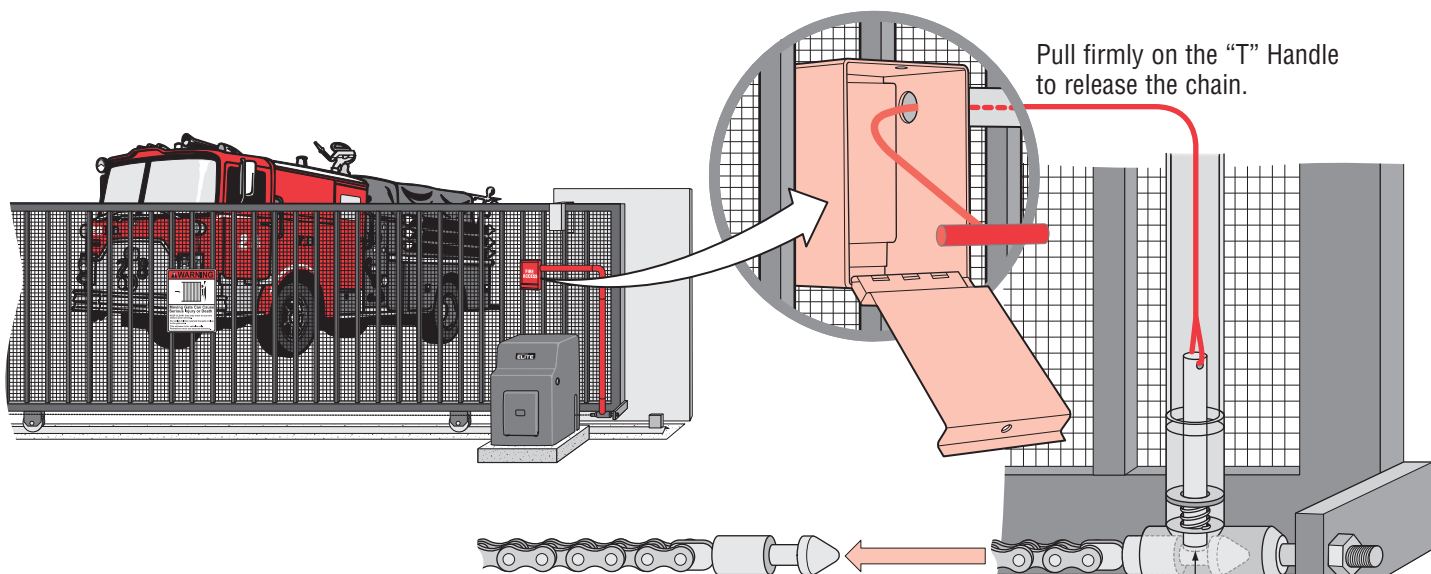

Pull firmly on the "T" Handle to release the chain.

The chain is held in place by a spring loaded pin.

**Contact your local dealer for information about a Fire Box Release.**

# Accessories

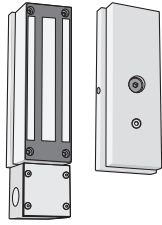

**Magnetic Lock (Outdoor)**  
Part # **MG1300**



**DC2000™ Kit**  
Part # **ODC2000SL**



**12Vdc External Loop Detectors**  
Part # **A79**



**Plug-In Loop Detectors**  
Part # **AELD**

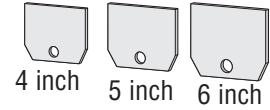

**Brackets**

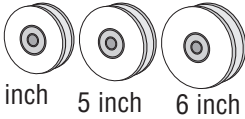

**V-Groove Power Wheels Series**



**Relay Adapter Module**  
Part # **Q400MAU**



**Quick Close Circuit (QCC)**  
Part # **OQCCOMNI**

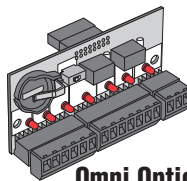

**Omni Option Board**  
Part # **OOMNIEXB**

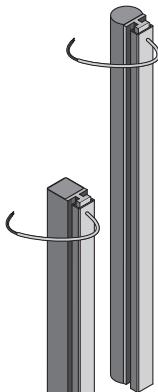

**UL Approved Round Sensing Edge**  
Part # **G65MGR20x**  
x = length (4, 5, 6, 8 ft)  
(e.g. **G65MGR206** is 6 ft)

**UL Approved Square Sensing Edge**  
Part # **G65MGS20x**  
x = length (4, 5, 6, 8 ft)  
(e.g. **G65MGS204** is 4 ft)

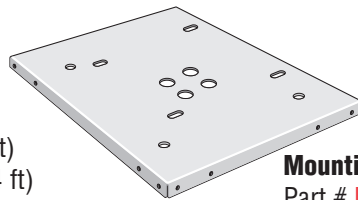

**Mounting Plate**  
Part # **MPEL**

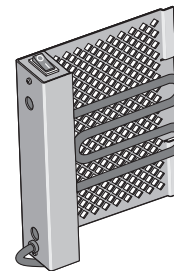

**Heater Kit**  
Part # **G6518SL**



**Remote Controls**



**3-Button Control Station**  
Part # **02-103**

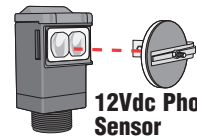

**12Vdc Photoelectric Sensor**  
Part # **AOMRON**

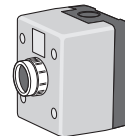

**Stop Button**  
Part # **AEXITP**

**LiftMaster**  
**SECURITY+**



**Mini 3-Button**  
Part # **370LM**



Part # **371LM**



Part # **373LM**



Part # **372LM**



Part # **374LM**

**LiftMaster**  
**PASSPORT™**



Part # **CPT13**



Part # **CPT33**



**Mini 3-Button**  
Part # **CPTK33**



Part # **CPT23**



Part # **CPT43**



**Mini 3-Button with HID Prox, Sensor**  
Part # **CPTK33PH**

For more information about accessories:  
[www.chamberlain.com](http://www.chamberlain.com)



# WIRING DIAGRAM • SL3000UL™

## Electronic Power Strip

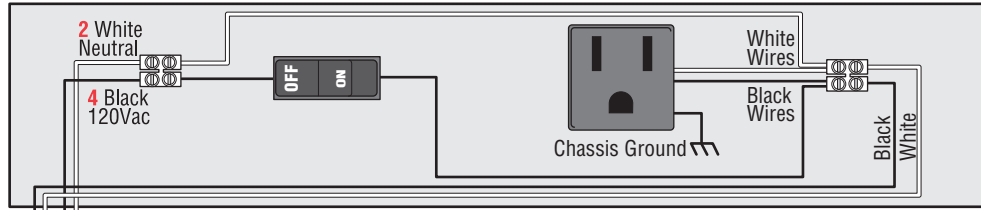

## OmniControl™ Board

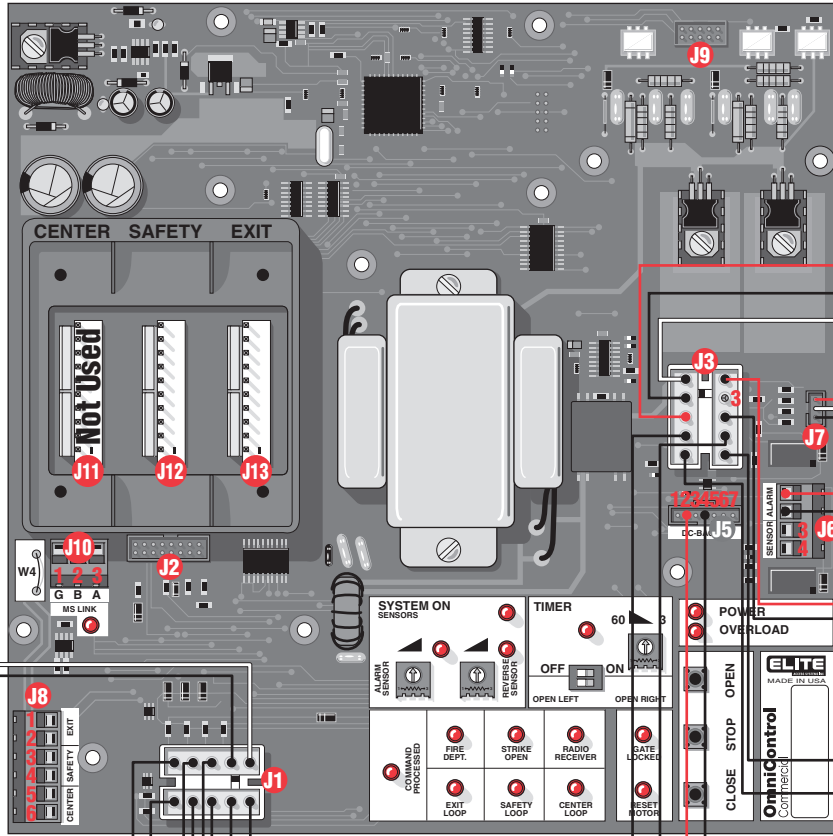

**Input Power**  
120Vac, 60 Hz,  
Grounded

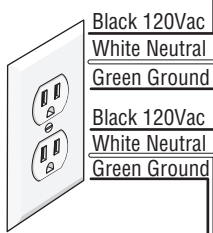

## Factory Heater

**NOTE:** Wires into main power and draws 3 amps.

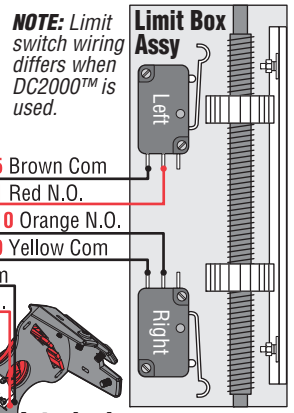
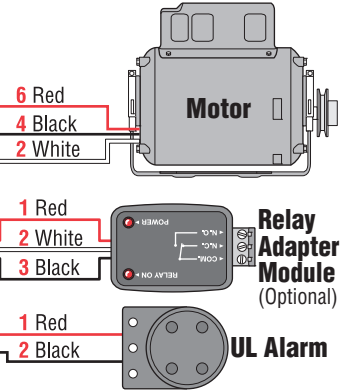
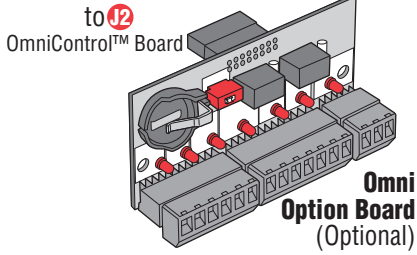
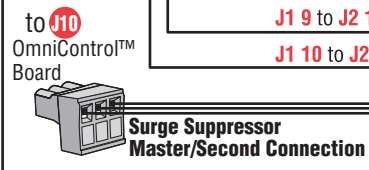
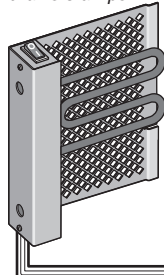

**NOTE:** Limit switch wiring differs when DC2000™ is used.



## Reset Switch

**NOTE:** Reset switch and interlock assembly connector differs when DC2000™ is used.

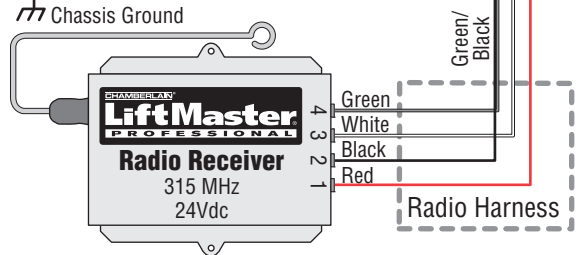
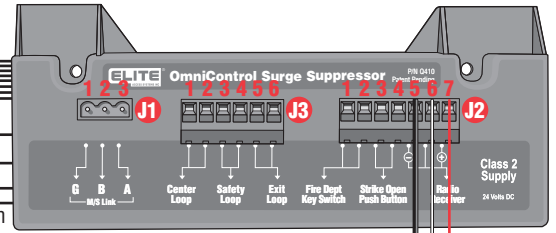

**NOTE:** See table on next page.

# WIRING TABLE • SL3000UL™

<i>OmniControl™ Board</i>					
<b>J #</b>	<b>J Pin #</b>	<b>Signal Type</b>	<b>Direction</b>	<b>Level (+/- 10%)</b>	<b>Input Connection</b>
J1	1	Safety Loop	In	5 or 0Vdc	External Loop Detector Wires, 120Vac Power, Radio Receiver, Strike Open, Key Switch Harness
J1	2	Input Power Neutral	In	0V	
J1	3	Not Used	–	–	
J1	4	Input Power 120Vac	In	120Vac	
J1	5	Strike Open	In	5 or 0Vdc	
J1	6	Exit Loop	In	5 or 0Vdc	
J1	7	Radio Receiver –	In	0V	
J1	8	Radio Receiver	In	0V	
J1	9	Fire Dept Key Switch	In	Dry	
J1	10	Radio Receiver +	Out	24Vdc	
J2	10 Pins	Omni Option Board	Out	24Vdc	Omni Option Board Input
J3	1	Limit Switch Red N.O.	Out	0V	Motor(s), Limit Switches, Maglock/Solenoid Harness
J3	2	Motor White	Out	0V	
J3	3	Normally Closed (No Wire)	In	5 or 0Vdc	
J3	4	Motor Black	Out	120Vac	
J3	5	Limit Switch Brown Com	In	0V	
J3	6	Motor Red	In	5 or 0Vdc	
J3	7	Purple Com	In	0V	
J3	8	Blue N.O.	In	5 or 0Vdc	
J3	9	Limit Switch Yellow Com	In	0V	
J3	10	Limit Switch Orange N.O.	In	5 or 0Vdc	
J5	1	–	In	–	Reset Switch and Interlock Assembly Input
J5	2	Reset Switch, Interlock Red	In	Dry	
J5	3	–	In	–	
J5	4	Reset Switch, Interlock Black	In	Dry	
J5	5	–	In	–	
J5	6	–	In	–	
J5	7	–	In	–	
J6	1	UL Alarm Red	Out	24Vdc	UL Alarm and Safety Sensors
J6	2	UL Alarm Black	Out	0Vdc	
J6	3	Safety Sensor	In	5 or 0Vdc	
J6	4	Safety Sensor	In	0V	
J7	1	Relay Adapter Red	In	5 or 0Vdc	Relay Adapter Module Input
J7	2	Relay Adapter White	In	0Vdc	
J7	3	Relay Adapter Black	In	0Vdc	
J8	1	Plug-In Exit Loop Wire	In	2 to 10Vdc	Plug-In Loop Detector Loop Wire Inputs
J8	2	Plug-In Exit Loop Wire	In	2 to 10Vdc	
J8	3	Plug-In Safety Loop Wire	In	2 to 10Vdc	
J8	4	Plug-In Safety Loop Wire	In	2 to 10Vdc	
J8	5	Not Used	–	–	
J8	6	Not Used	–	–	
J9	16 Pins	1 HP Board	–	–	Not Used
J10	1	G M/S Link	In/Out	0Vdc	Master/Second Link
J10	2	B M/S Link	In/Out	5 or 0Vdc	
J10	3	A M/S Link	In/Out	5 or 0Vdc	
J11	10 Pins	Not Used	–	–	Plug-In Loop
J12	10 Pins	Safety Loop Detector	In	5 or 0Vdc	Detector Inputs
J13	10 Pins	Exit Loop Detector	In	5 or 0Vdc	

<i>OmniControl™ Surge Suppressor</i>					
J1	1	G M/S Link (G)	In/Out	0V	Master/Second Link Input
J1	2	B M/S Link (B)	In/Out	5 or 0Vdc	
J1	3	A M/S Link (A)	In/Out	5 or 0Vdc	
J2	1	Fire Dept. Key Switch (7)	In	Dry	Radio Receiver, Strike Open Push Button, Fire Dept Key Switch Inputs
J2	2	Fire Dept. Key Switch (8)	In	Dry	
J2	3	Strike Open Push Button (9)	In	5 or 0Vdc	
J2	4	Strike Open Push Button (10)	In	0V	
J2	5	Radio Receiver – (11)	In	0V	
J2	6	Radio Receiver (12)	In	5 or 0Vdc	
J2	7	Radio Receiver + (13)	Out	24Vdc	
J3	1	Not Used	–	–	External Loop Detector Center, Safety, Exit Wires Input
J3	2	Not Used	–	–	
J3	3	Safety External Loop Detector (3)	In	2 to 10Vdc	
J3	4	Safety External Loop Detector (4)	In	2 to 10Vdc	
J3	5	Exit External Loop Detector (5)	In	2 to 10Vdc	
J3	6	Exit External Loop Detector (6)	In	2 to 10Vdc	

# WIRING DIAGRAM • SL3000ULD™

## Electronic Power Strip

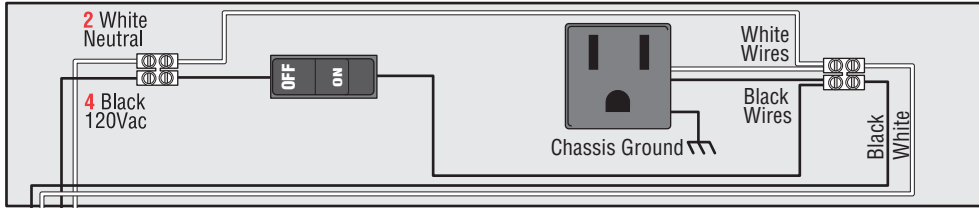

## OmniControl™ Board

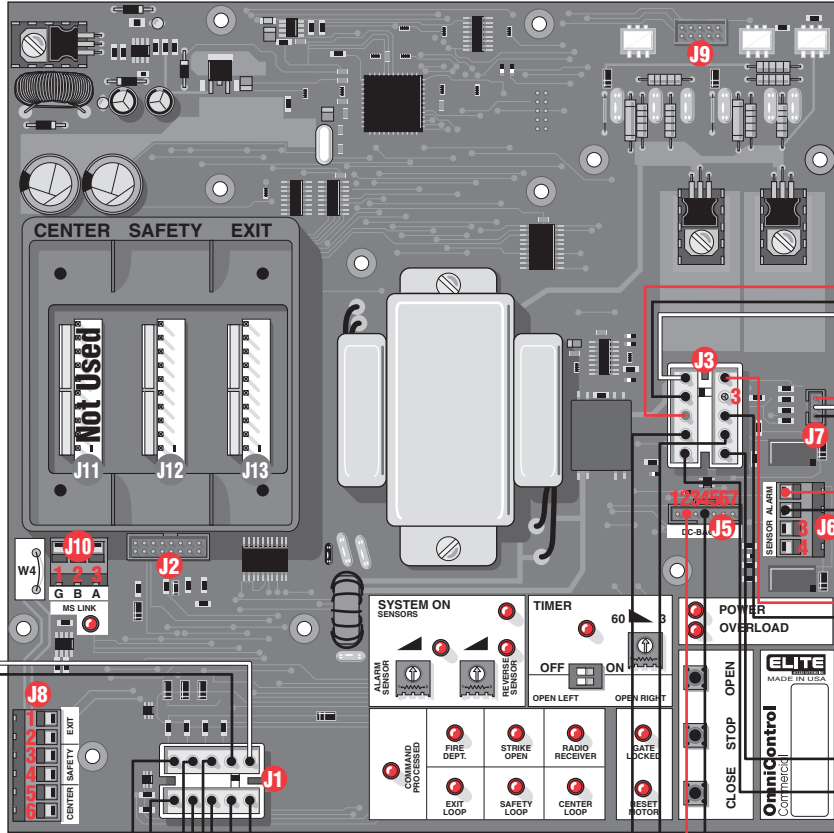

**Input Power**  
120Vac, 60 Hz,  
Grounded

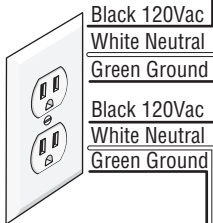

## Factory Heater

**NOTE:** Wires into main power and draws 3 amps.

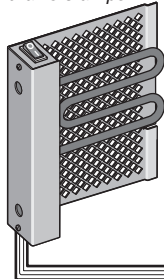

to **J10**  
OmniControl™  
Board

**Surge Suppressor  
Master/Second Connection**

to **J2**  
OmniControl™  
Board

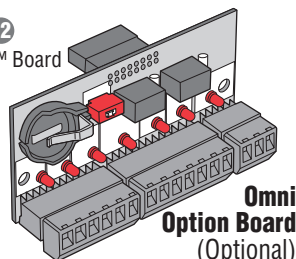

**Omni  
Option Board  
(Optional)**

4 Black  
2 White

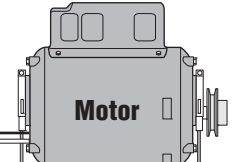

2 White  
6 Red

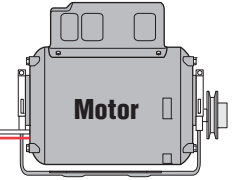

1 Red  
2 White  
3 Black

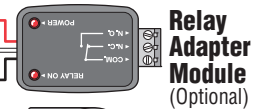

**Relay  
Adapter  
Module  
(Optional)**

1 Red  
2 Black



**UL Alarm**

**NOTE:** Limit  
switch wiring  
differs when  
DC2000™ is  
used.

1 Red N.O.  
5 Brown Com  
10 Orange N.O.  
9 Yellow Com

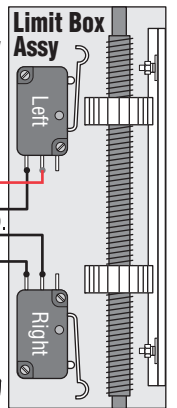

8 Blue N.C.  
7 Purple Com

4 Com  
2 N.O.  
4 Com  
4 Black  
2 Red

## Reset Switch

**NOTE:** Reset switch and interlock assembly connector differs when DC2000™ is used.

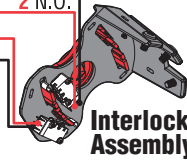

## Interlock Assembly

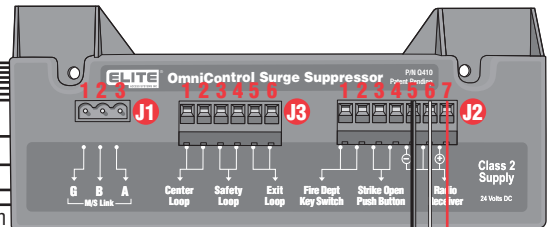

Green  
Chassis Ground

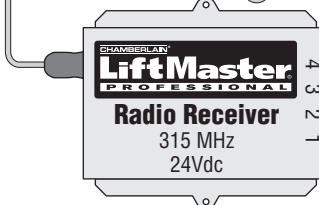

**Radio Harness**

**NOTE:** See table on next page.

# WIRING TABLE • SL3000ULDM™

<b>OmniControl™ Board</b>					
<b>J #</b>	<b>J Pin #</b>	<b>Signal Type</b>	<b>Direction</b>	<b>Level (+/- 10%)</b>	<b>Input Connection</b>
J1	1	Safety Loop	In	5 or 0Vdc	External Loop Detector Wires, 120Vac Power, Radio Receiver, Strike Open, Key Switch Harness
J1	2	Input Power Neutral	In	0V	
J1	3	Not Used	–	–	
J1	4	Input Power 120Vac	In	120Vac	
J1	5	Strike Open	In	5 or 0Vdc	
J1	6	Exit Loop	In	5 or 0Vdc	
J1	7	Radio Receiver –	In	0V	
J1	8	Radio Receiver	In	0V	
J1	9	Fire Dept Key Switch	In	Dry	
J1	10	Radio Receiver +	Out	24Vdc	
J2	10 Pins	Omni Option Board	Out	24Vdc	Omni Option Board Input
J3	1	Limit Switch Red N.O.	Out	0V	Motor(s), Limit Switches, Maglock/Solenoid Harness
J3	2	Motor White	Out	0V	
J3	3	Normally Closed (No Wire)	In	5 or 0Vdc	
J3	4	Motor Black	Out	120Vac	
J3	5	Limit Switch Brown Com	In	0V	
J3	6	Motor Red	In	5 or 0Vdc	
J3	7	Purple Com	In	0V	
J3	8	Blue N.O.	In	5 or 0Vdc	
J3	9	Limit Switch Yellow Com	In	0V	
J3	10	Limit Switch Orange N.O.	In	5 or 0Vdc	
J5	1	–	In	–	Reset Switch and Interlock Assembly Input
J5	2	Reset Switch, Interlock Red	In	Dry	
J5	3	–	In	–	
J5	4	Reset Switch, Interlock Black	In	Dry	
J5	5	–	In	–	
J5	6	–	In	–	
J5	7	–	In	–	
J6	1	UL Alarm Red	Out	24Vdc	UL Alarm and Safety Sensors
J6	2	UL Alarm Black	Out	0Vdc	
J6	3	Safety Sensor	In	5 or 0Vdc	
J6	4	Safety Sensor	In	0V	
J7	1	Relay Adapter Red	In	5 or 0Vdc	Relay Adapter Module Input
J7	2	Relay Adapter White	In	0Vdc	
J7	3	Relay Adapter Black	In	0Vdc	
J8	1	Plug-In Exit Loop Wire	In	2 to 10Vdc	Plug-In Loop Detector Loop Wire Inputs
J8	2	Plug-In Exit Loop Wire	In	2 to 10Vdc	
J8	3	Plug-In Safety Loop Wire	In	2 to 10Vdc	
J8	4	Plug-In Safety Loop Wire	In	2 to 10Vdc	
J8	5	Not Used	–	–	
J8	6	Not Used	–	–	
J9	16 Pins	1 HP Board	–	–	Not Used
J10	1	G M/S Link	In/Out	0Vdc	Master/Second Link
J10	2	B M/S Link	In/Out	5 or 0Vdc	
J10	3	A M/S Link	In/Out	5 or 0Vdc	
J11	10 Pins	Not Used	–	–	Plug-In Loop Detector Inputs
J12	10 Pins	Safety Loop Detector	In	5 or 0Vdc	
J13	10 Pins	Exit Loop Detector	In	5 or 0Vdc	

<b>OmniControl™ Surge Suppressor</b>					
J1	1	G M/S Link (G)	In/Out	0V	Master/Second Link Input
J1	2	B M/S Link (B)	In/Out	5 or 0Vdc	
J1	3	A M/S Link (A)	In/Out	5 or 0Vdc	
J2	1	Fire Dept. Key Switch (7)	In	Dry	Radio Receiver, Strike Open Push Button, Fire Dept Key Switch Inputs
J2	2	Fire Dept. Key Switch (8)	In	Dry	
J2	3	Strike Open Push Button (9)	In	5 or 0Vdc	
J2	4	Strike Open Push Button (10)	In	0V	
J2	5	Radio Receiver – (11)	In	0V	
J2	6	Radio Receiver (12)	In	5 or 0Vdc	
J2	7	Radio Receiver + (13)	Out	24Vdc	
J3	1	Not Used	–	–	External Loop Detector Center, Safety, Exit Wires Input
J3	2	Not Used	–	–	
J3	3	Safety External Loop Detector (3)	In	2 to 10Vdc	
J3	4	Safety External Loop Detector (4)	In	2 to 10Vdc	
J3	5	Exit External Loop Detector (5)	In	2 to 10Vdc	
J3	6	Exit External Loop Detector (6)	In	2 to 10Vdc	



# WIRING DIAGRAM • SL3000UL1HP™

## Electronic Power Strip

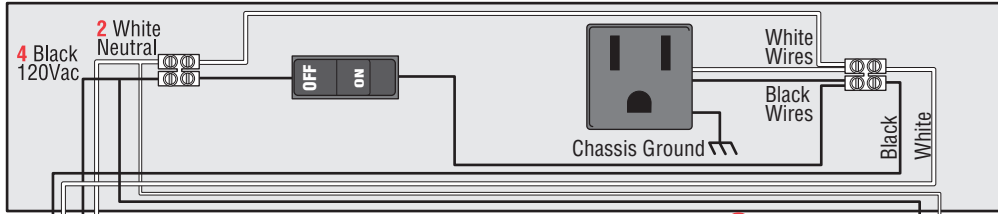

## OmniControl™ Board

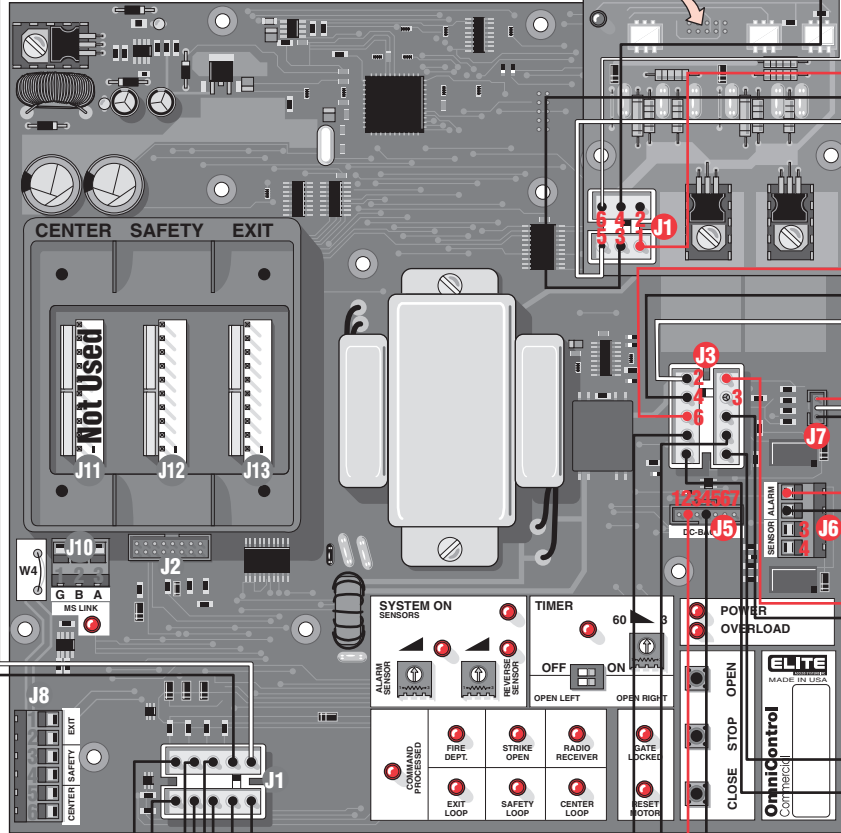

**Input Power**  
120Vac, 60 Hz,  
Grounded

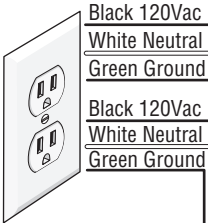

**Factory Heater**  
*NOTE: Wires into main power and draws 3 amps.*

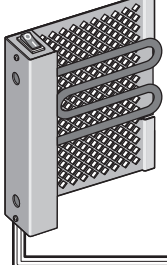

- J1 1 to J3 3-4 Safety Loop
- J1 3 to J3 1-2 Center Loop (Not Used)
- J1 5 to J2 3-4 Strike Open Push Button
- J1 6 to J3 5-6 Exit Loop
- J1 7 to J2 5 Radio Receiver Neg.
- J1 8 to J2 6 Radio Receiver
- J1 9 to J2 1-2 Fire Dept Key Switch
- J1 10 to J2 7 Radio Receiver +

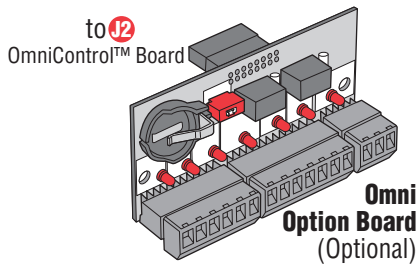

## 1 HP Board

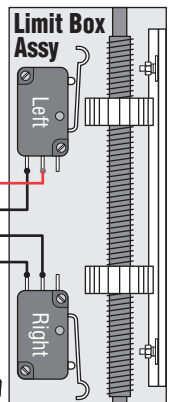
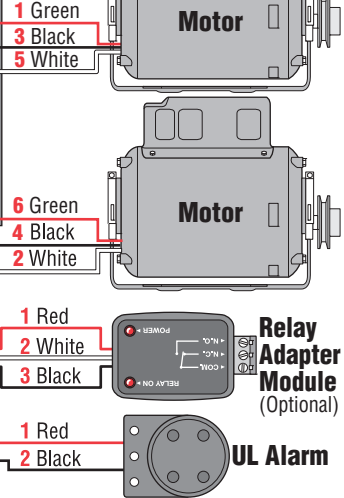
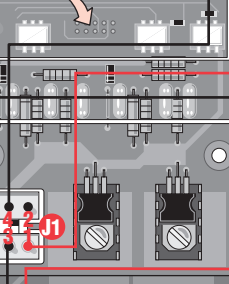

## Reset Switch

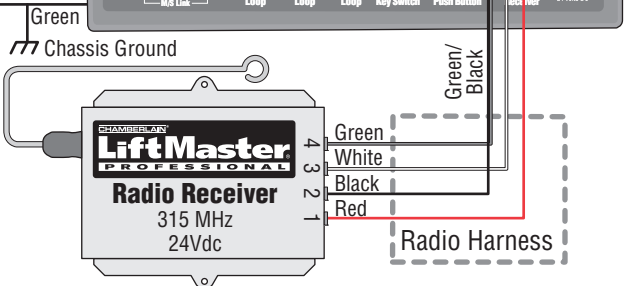
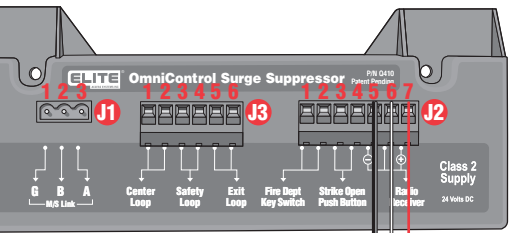

**NOTE:** See table on next page.

# WIRING TABLE • SL3000UL1HP™

OmniControl™ Board					
J #	J Pin #	Signal Type	Direction	Level (+/- 10%)	Input Connection
J1	1	Safety Loop	In	5 or 0Vdc	External Loop Detector Wires, 120Vac Power, Radio Receiver, Strike Open, Key Switch Harness
J1	2	Input Power Neutral	In	0V	
J1	3	Not Used	—	—	
J1	4	Input Power 120Vac	In	120Vac	
J1	5	Strike Open	In	5 or 0Vdc	
J1	6	Exit Loop	In	5 or 0Vdc	
J1	7	Radio Receiver –	In	0V	
J1	8	Radio Receiver	In	0V	
J1	9	Fire Dept Key Switch	In	Dry	
J1	10	Radio Receiver +	Out	24Vdc	
J2	10 Pins	Omni Option Board	Out	24Vdc	Omni Option Board Input
J3	1	Limit Switch Red N.O.	In	5 or 0Vdc	Limit Switches, Maglock/Solenoid Harness
J3	2	—	—	—	
J3	3	Normally Closed (No Wire)	In	5 or 0Vdc	
J3	4	—	—	—	
J3	5	Limit Switch Brown Com	In	0V	
J3	6	—	—	—	
J3	7	Purple Com	In	0V	
J3	8	Blue N.O.	In	5 or 0Vdc	
J3	9	Limit Switch Yellow Com	In	0V	
J3	10	Limit Switch Orange N.O.	In	5 or 0Vdc	
J5	1	—	In	—	Reset Switch and Interlock Assembly Input
J5	2	Reset Switch, Interlock Red	In	Dry	
J5	3	—	In	—	
J5	4	Reset Switch, Interlock Black	In	Dry	
J5	5	—	In	—	
J5	6	—	In	—	
J5	7	—	In	—	
J6	1	UL Alarm Red	Out	24Vdc	UL Alarm and Safety Sensors
J6	2	UL Alarm Black	Out	0Vdc	
J6	3	Safety Sensor	In	5 or 0Vdc	
J6	4	Safety Sensor	In	0V	
J7	1	Relay Adapter Red	In	5 or 0Vdc	Relay Adapter Module Input
J7	2	Relay Adapter White	In	0Vdc	
J7	3	Relay Adapter Black	In	0Vdc	
J8	1	Plug-In Exit Loop Wire	In	2 to 10Vdc	Plug-In Loop Detector Loop Wire Inputs
J8	2	Plug-In Exit Loop Wire	In	2 to 10Vdc	
J8	3	Plug-In Safety Loop Wire	In	2 to 10Vdc	
J8	4	Plug-In Safety Loop Wire	In	2 to 10Vdc	
J8	5	Plug-In Center Loop Wire	In	2 to 10Vdc	
J8	6	Plug-In Center Loop Wire	In	2 to 10Vdc	
J9	16 Pins	1 HP Board	In	120Vac	1 HP Board Input
J10	1	G M/S Link	In/Out	0Vdc	Master/Second Link
J10	2	B M/S Link	In/Out	5 or 0Vdc	
J10	3	A M/S Link	In/Out	5 or 0Vdc	
J11	10 Pins	Not Used	—	—	Plug-In Loop Detector Inputs
J12	10 Pins	Safety Loop Detector	In	5 or 0Vdc	
J13	10 Pins	Exit Loop Detector	In	5 or 0Vdc	
1 HP Board					
J1	1	Motor Red	Out	0V	2 Motors Input
J1	2	Motor Black	Out	120Vac	
J1	3	Motor White Neutral	Out	0V	
J1	4	—	—	—	
J1	5	Motor Black	Out	120Vac	
J1	6	Motor White Neutral	Out	0V	
OmniControl™ Surge Suppressor					
J1	1	G M/S Link (G)	In/Out	0V	Master/Second Link Input
J1	2	B M/S Link (B)	In/Out	5 or 0Vdc	
J1	3	A M/S Link (A)	In/Out	5 or 0Vdc	
J2	1	Fire Dept. Key Switch (7)	In	Dry	Radio Receiver, Strike Open Push Button, Fire Dept Key Switch Inputs
J2	2	Fire Dept. Key Switch (8)	In	Dry	
J2	3	Strike Open Push Button (9)	In	5 or 0Vdc	
J2	4	Strike Open Push Button (10)	In	0V	
J2	5	Radio Receiver – (11)	In	0V	
J2	6	Radio Receiver (12)	In	5 or 0Vdc	
J2	7	Radio Receiver + (13)	Out	24Vdc	
J3	1	Not Used	—	—	External Loop Detector Center, Safety, Exit Wires Input
J3	2	Not Used	—	—	
J3	3	Safety External Loop Detector (3)	In	2 to 10Vdc	
J3	4	Safety External Loop Detector (4)	In	2 to 10Vdc	
J3	5	Exit External Loop Detector (5)	In	2 to 10Vdc	
J3	6	Exit External Loop Detector (6)	In	2 to 10Vdc	

# WIRING DIAGRAM • DC2000™ FOR SINGLE AND DM

**NOTE:** This diagram only shows the DC2000™ wiring and all other wiring not shown is the same as the diagram on the single or dual motor models.

The 1 HP models **Can Not** have the DC2000™ Battery Backup system.

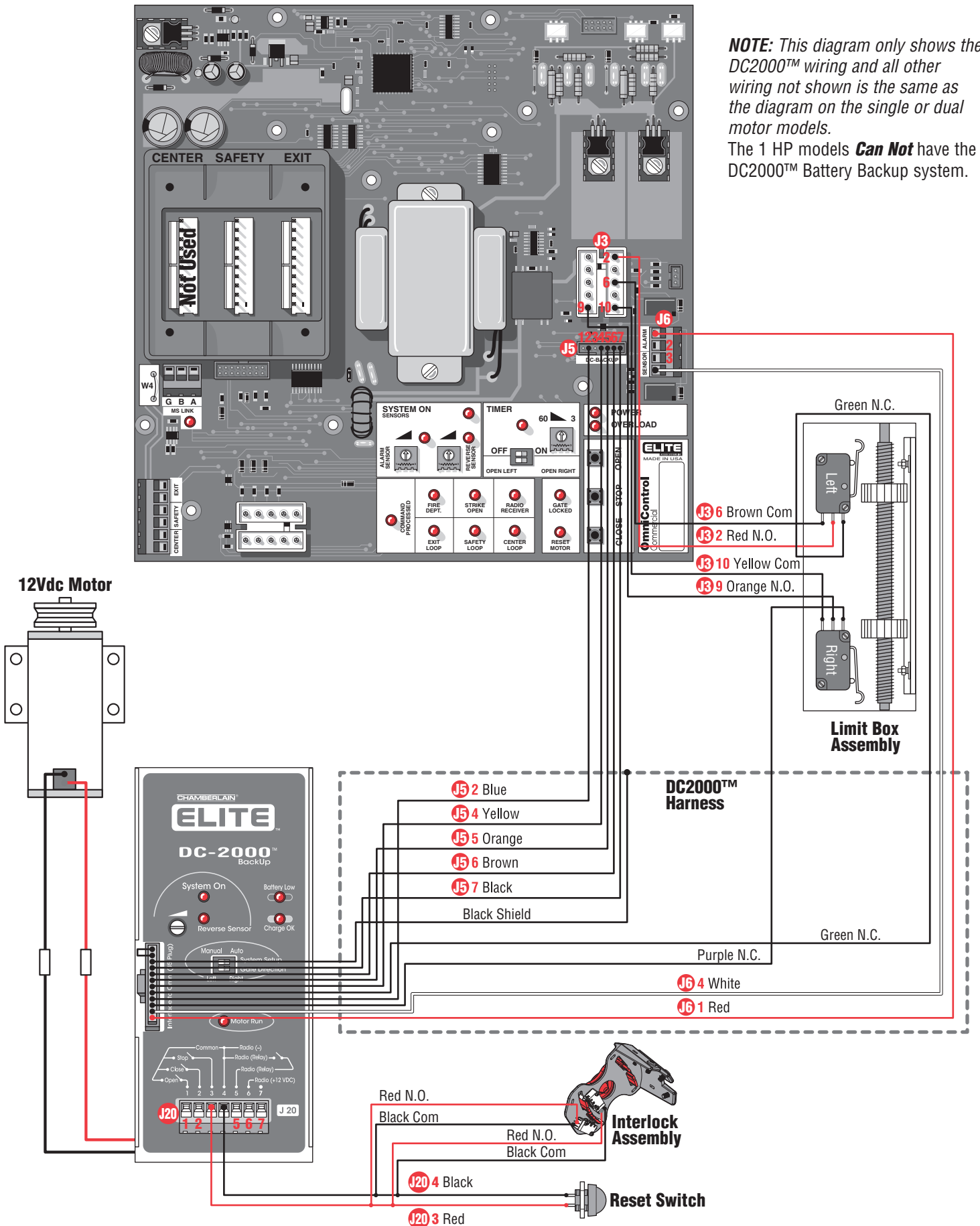

# WIRING TABLE • DC2000™

**NOTE:** All devices wired to the DC2000™ MUST be **dedicated** to it alone. Normal operation will be controlled by **separate** devices wired to the OmniControl™ board and surge suppressor.

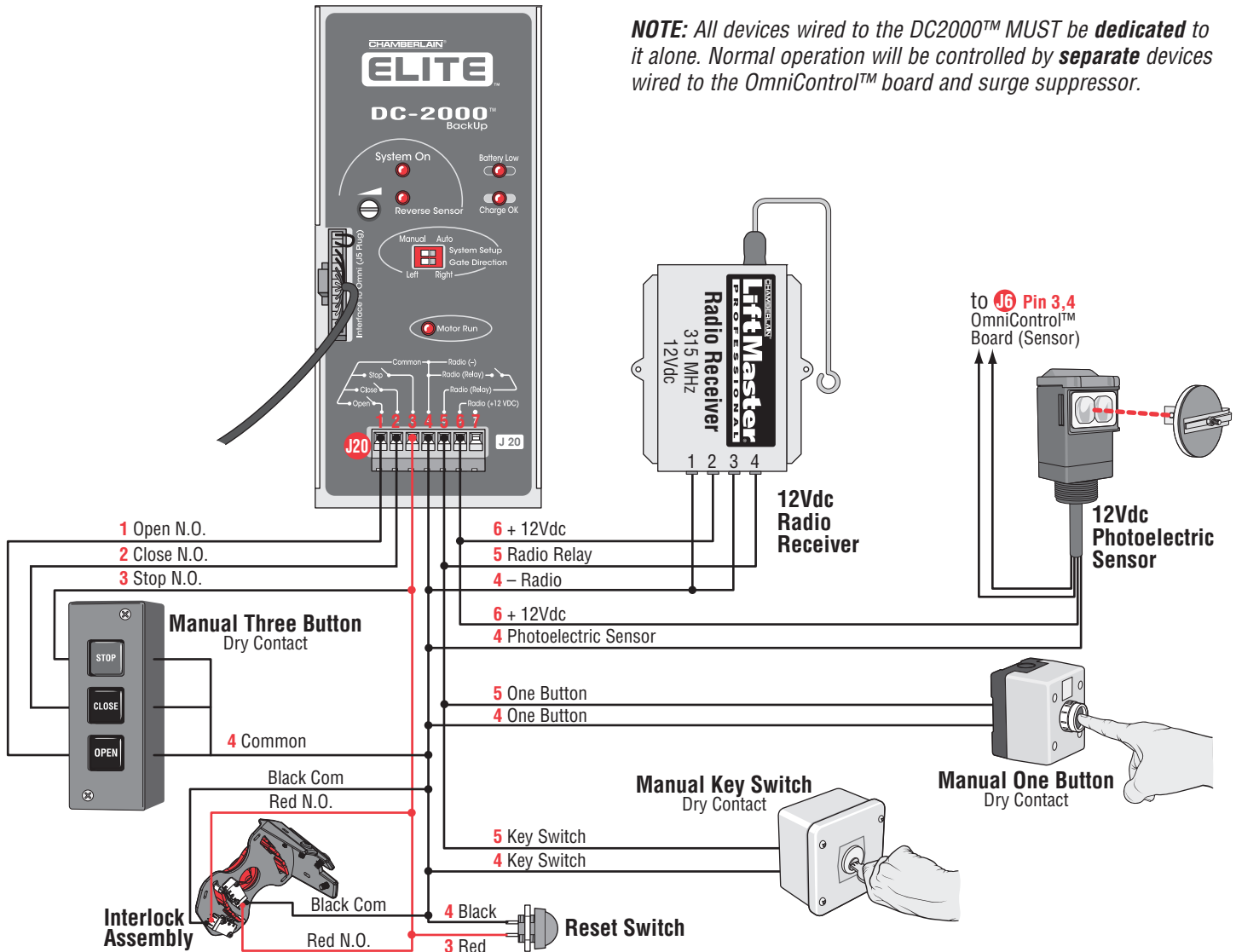

J #	J Pin #	Signal Type	Direction	Level (+/- 10%)	Input Connection
J20	1	Open N.O.	Out	5 or 0Vdc	• Manual Three Button (Dry)  Reset Switch
J20	2	Close N.O.	Out	5 or 0Vdc	
J20	3	Stop N.O. Reset Switch	Out	5 or 0Vdc	
J20	4	Common Radio - Radio Relay Reset Switch/Interlock Assembly	Out	0V	• Manual One Button (Dry) • Key Switch (Dry) • Radio Receiver Reset Switch/Interlock Assy
J20	5	One Button Key Switch Radio Relay	Out	0V	• Manual One Button (Dry) • Key Switch (Dry) • Radio Receiver
J20	6	Radio + 12Vdc Photoelectric Sensor + 12Vdc	Out	12 or 0Vdc	• Radio Receiver 12Vdc • Photoelectric Sensor 12Vdc
J20	7	-	-	-	-

# Troubleshooting

## The Gate Will Not Operate with Remote:

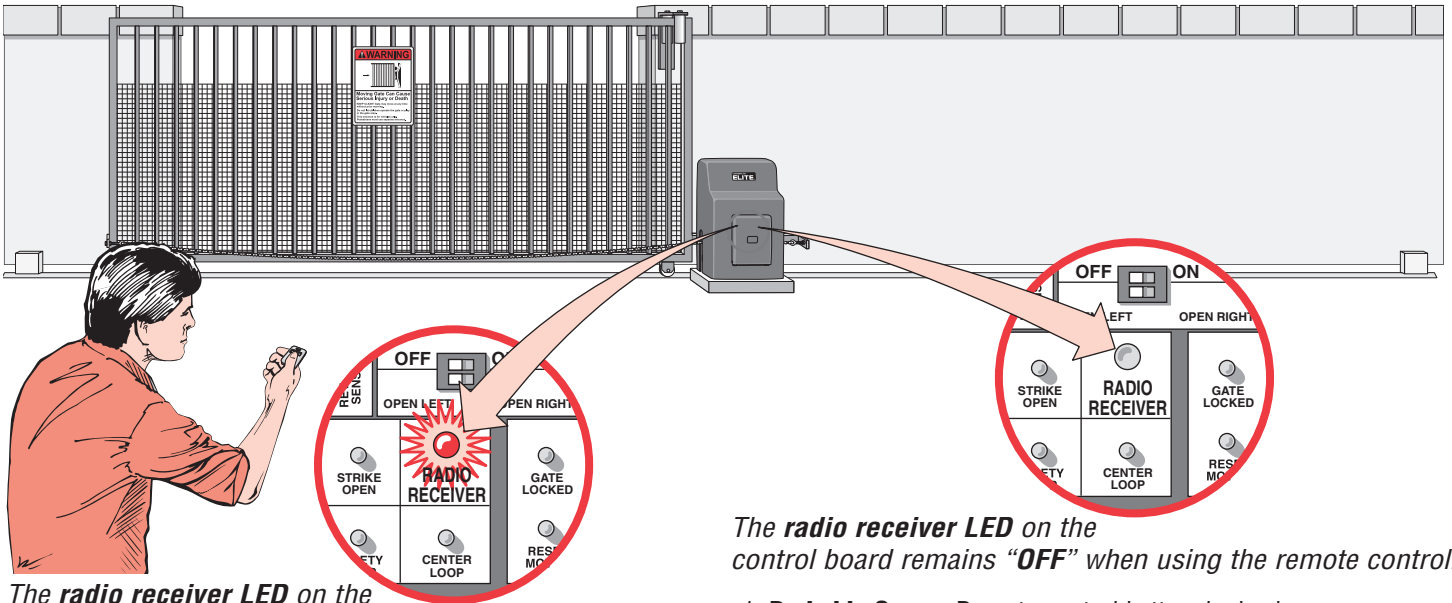

The radio receiver LED on the control board remains “ON” when using the remote control.

1. **Probable Cause:** Stuck remote control button.  
**Solution:** Unstick remote control button.
2. **Probable Cause:** The radio receiver has malfunctioned in the “ON” position.  
**Solution:** Cycle the power to the radio receiver.

The radio receiver LED on the control board remains “OFF” when using the remote control.

1. **Probable Cause:** Remote control battery is dead.  
**Solution:** Replace remote control battery.
2. **Probable Cause:** The radio receiver has malfunctioned in the “OFF” position.  
**Solution:** Cycle the power to the radio receiver.
3. **Probable Cause:** Radio receiver’s signal is not getting to gate operator.  
**Solution:** Check wiring between receiver and surge suppressor.
4. **Probable Cause:** Remote is not programmed correctly.  
**Solution:** Reprogram remote control, see page 28.
5. **Probable Cause:** Remote is not on the same frequency as the radio receiver.  
**Solution:** Verify that remote control frequency is 315 MHz.
6. **Probable Cause:** Blown surge suppressor.  
**Solution:** Measure the resistance between pin 12 and 13 on the surge suppressor (see page 14), if the circuit “closes” when the radio receiver is transmitting, replace the surge suppressor.

## Resetting Motor(s)

**NOTE:** Press firmly to reset thermal breaker button(s). A long slotted screwdriver may be needed to reach button on upper motor.

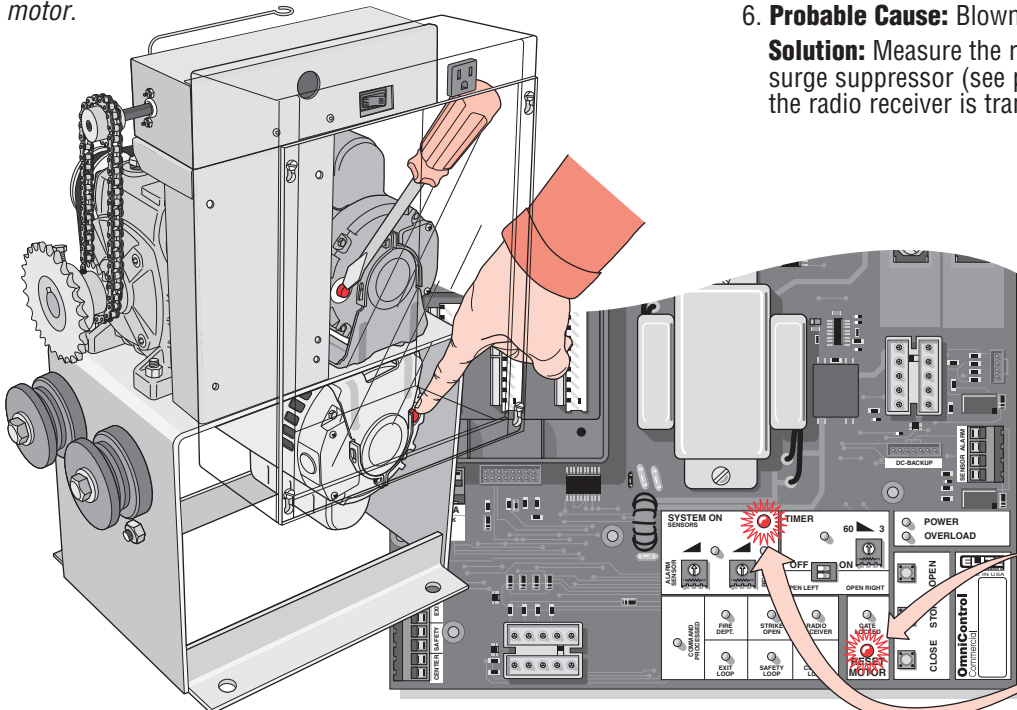

Motor(s) need resetting when:  
Reset Motor LED light flashes once,  
THEN  
System ON LED will flash rapidly

## TROUBLESHOOTING CONTINUED

<i>Condition</i>	<i>Probable Causes</i>	<i>Solution</i>
<b>Overload LED ON and Power LED OFF</b>	<ol style="list-style-type: none"> <li>1. Short circuit at terminals 11 and 13.</li> <li>2. Short circuit at any of the loop detectors in the board.</li> <li>3. Short circuit in the control board.</li> </ol>	<ol style="list-style-type: none"> <li>1. Remove the short circuit condition at the terminals.</li> <li>2. Remove the defective loop detector.</li> <li>3. Send the board to repair.</li> </ol>
<b>Overload LED ON and Power LED ON</b>	<ol style="list-style-type: none"> <li>1. Excessive current draw at terminal 13.</li> <li>2. Over-voltage at the 120Vac line input.</li> </ol>	<ol style="list-style-type: none"> <li>1. Reduce the accessories load from surge suppressor terminal 13.</li> <li>2. Verify your electrical power.</li> </ol>
<b>System On LED Flashing</b>	<ol style="list-style-type: none"> <li>1. Motor thermal fuse has popped-out (Rapid Flashing).</li> <li>2. One limit switch is faulty (Rapid Flashing).</li> </ol>	<ol style="list-style-type: none"> <li>1. Reset the motor.</li> <li>2. Test the limit switches and wire connections, fix the fault.</li> </ol>
<b>Reverse Sensor LED ON</b>	<ol style="list-style-type: none"> <li>1. Gate has encountered an obstruction during traveling.</li> <li>2. Reverse sensor is extra sensitive..</li> </ol>	<ol style="list-style-type: none"> <li>1. Remove the obstruction.</li> <li>2. Turn the reverse sensor switch counter-clockwise a little more and try again.</li> </ol>
<b>Alarm Sensor LED ON</b>	<ol style="list-style-type: none"> <li>1. Gate encountered an obstruction during traveling.</li> <li>2. Alarm sensor is extra sensitive.</li> </ol>	<ol style="list-style-type: none"> <li>1. Remove the obstruction.</li> <li>2. Turn the alarm sensor switch counter clockwise a little more and try again.</li> </ol>
<b>Command Processed LED ON</b>	<ol style="list-style-type: none"> <li>1. There is a command hold active.</li> </ol>	<ol style="list-style-type: none"> <li>1. This is a normal response of the gate operator. It does not represent necessarily that there is a problem.</li> </ol>
<b>Timer LED Blinking and Command Processed LED Blinking</b>	<ol style="list-style-type: none"> <li>1. There is a command holding the gate open.</li> </ol>	<ol style="list-style-type: none"> <li>1. This is a normal response of the gate operator. It does not represent necessarily that there is a problem. Check inputs for command.</li> </ol>
<b>Timer LED Blinking, Command Processed LED Blinking and Reverse Sensor LED ON</b>	<ol style="list-style-type: none"> <li>1. Gate has reopened because it encountered an obstruction while closing.</li> </ol>	<ol style="list-style-type: none"> <li>1. Any re-new command will resume normal operation. Check for obstructions.</li> </ol>
<b>Audio Alarm ON</b>	<ol style="list-style-type: none"> <li>1. Gate has encountered two consecutive obstructions while trying to close or open.</li> </ol>	<ol style="list-style-type: none"> <li>1. Any re-new command will resume normal operation but not a radio command. Check for obstructions.</li> <li>2. You can stop the alarm by using the built-in reset button.</li> <li>3. You can stop the alarm by using an optional stop button.</li> </ol>
<b>Any Loop LED ON and No vehicle on the sensing area</b>	<ol style="list-style-type: none"> <li>1. The loop detector needs to be reset.</li> <li>2. The wire loop has been disrupted.</li> <li>3. The loop detector needs to work in a different frequency.</li> <li>4. The loop detector is too sensitive.</li> </ol>	<ol style="list-style-type: none"> <li>1. Reset the loop detector (If you use Elite Plug-in Loop detectors, change the setting for sensitivity and come back to your original setting).</li> <li>2. Verify and correct connections.</li> <li>3. Set a different working frequency.</li> <li>4. Decrease the sensitivity of the loop detector.</li> </ol>

For technical support: **1-800-528-2806**

# Repair Parts

## REPAIR PART ILLUSTRATIONS

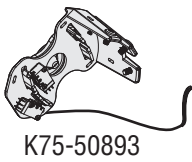
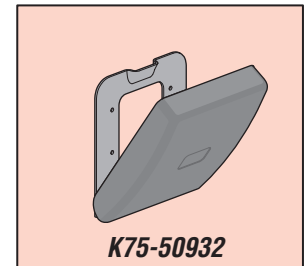
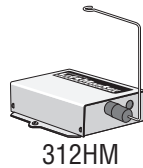
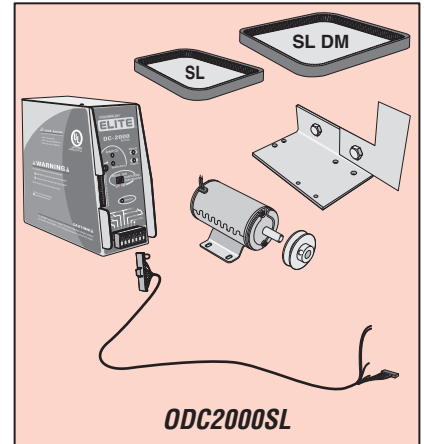
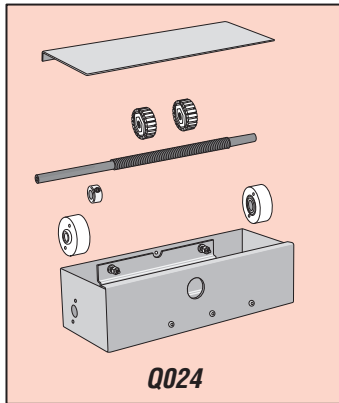
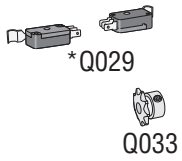

Q030



Q237



Q027

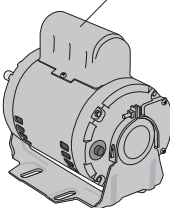

Q025

Q021

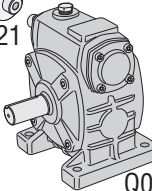

\*Q018

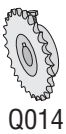
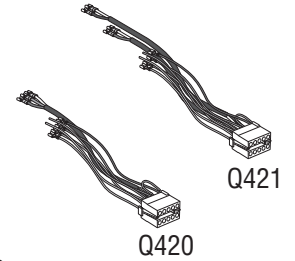
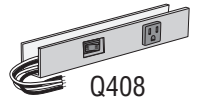
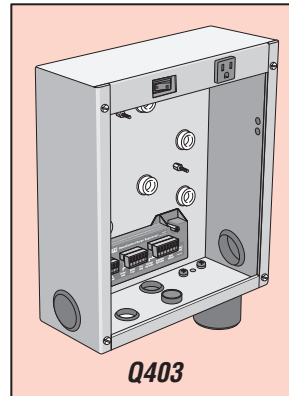
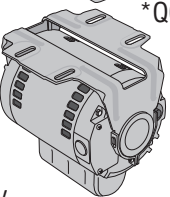

Q016



Q015 or  
32-50091-10  
Model SL3000ULE Only

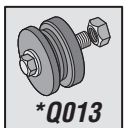

Master Link



Chain

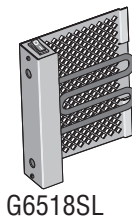
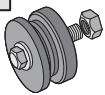

K23-51158

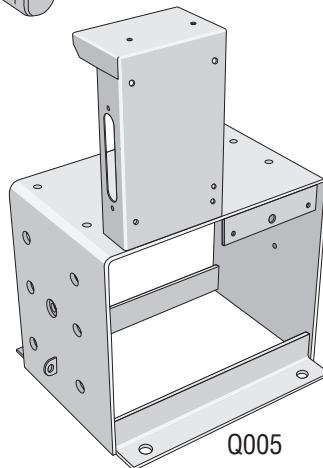

Q400D

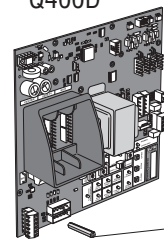

Q407

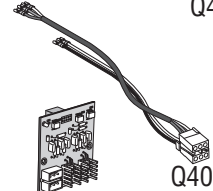

Q006

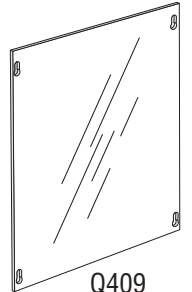
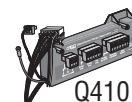

77-50382

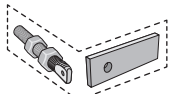

**NOTE:** \* Sold Individually, 2 shown.  
list on next page.

# HOW TO ORDER REPAIR PARTS

OUR LARGE SERVICE ORGANIZATION SPANS AMERICA. INSTALLATION AND SERVICE INFORMATION IS AS NEAR AS YOUR TELEPHONE. SIMPLY DIAL OUR TOLL FREE NUMBER:

**1-800-528-2806**

www.chamberlain.com

WHEN ORDERING REPAIR PARTS, ALWAYS GIVE THE FOLLOWING INFORMATION:

- PART NUMBER
- PART NAME
- MODEL NUMBER

Address orders to:

**THE CHAMBERLAIN GROUP, INC.**

*Technical Support Group  
6020 S. Country Club Road  
Tucson, Arizona 85706*

## REPAIR PART NAMES AND NUMBERS

**Crank Housing Kit - K75-50932** - Manual Crank not Included

**Power Back-Up Unit - ODC2000SL**

- Drive Belt DC SL
- Drive Belt DC SL (DM)
- Back-Up Motor DC 12V
- Chassis DC Back-Up
- Hardware Kit for DC Back-Up
- Wire Harness DC2000
- Pulley DC2000 1/2 ID

**Idler Pulley Assembly - Q013**

- Bushing, 7/8" OD, .120" Wall x 1.950"
- Pulley, Idler, Molded Plastic, SL
- Screw, Hex, 5/8-11 x 2 3/4", Grade 5
- Nut, Hex, Jam, 5/8 -, S/Z
- Washer, Flat, 5/8", SAE, S/Z

**Limit Switch Assembly - Q024**

- Limit Switch Bolt
- Limit Switch Adjustment Nuts
- Limit Switch Sprocket
- Limit Switch Bearing Holder
- Collar 3/8"

**Control Box Assembly - Q403**

- Electronic Metal Box
- Surge Suppressor
- Audio Alarm

**Hardware Kit - 77-50382**

- Chain Bolt
- Chain Bracket

- 1941240D - Chain no. 41 (10 ft)
- 1940240D - Chain no. 40 (10 ft)
- 1941240DNP - Chain no. 41 (Nickel Plated)
- 1950307 - Master Link no. 41
- 1950310 - Master Link no. 40
- K23-51158 - Reset Switch Assembly
- K75-50893 - Safety and Interlock Assembly
- G6518SL - Heater
- Q005 - SL-3000 Chassis
- Q006 - PC Board Nuts (1 Set)
- Q014 - Drive Sprocket
- Q015 - Gear Reducer
- 32-50091-10 - Gear Reducer (Model SL3000ULE only)
- Q016 - Limit Switch Drive Sprocket
- Q018 - 1/2 HP Electric Motor
- Q020 - Drive Belt
- Q021 - Gear Pulley
- Q025 - Motor Pulley
- Q027 - Motor Capacitor
- Q028 - Manual Crank
- Q029 - Limit Switch
- Q030 - Limit Switch/Chain
- Q039 - Drive Belt, DM and 1 HP
- Q237 - Crank Input
- K75-51048 - Cover HD Polyethylene SL
- Q400D - Omni Main PCB (OmniControl™)
- Q401 - Omni 1 HP Board
- Q404 - Omni Siren
- Q407 - Omni Motor Harness 1 HP
- Q408 - Omni Switch Channel
- Q409 - Control Box Cover
- Q410 - Surge Suppressor Terminal Block
- Q420 - Omni Motor Harness Single Motor
- Q421 - Omni Motor Harness DM
- 312HM - Radio Receiver

**NOTE:** **Assembly Parts Number**



# Installation Checklist

1. Owner and Installer **must** read all warnings and safety precautions.
2. Make sure concrete mounting pad is big enough and deep enough for operator.
3. Operator must be **securely** fastened to concrete pad.
4. Operator chain must be **4 inch minimum** from gate. Chain must not be too tight or too loose.
5. Gate operator should be grounded to an earth ground within 3 feet.
6. Verify that power is connected properly. **Know where the main power disconnect is for operator(s).**
7. Verify that the gate opens and closes as needed.
8. When gate hits object during operation, it **must** stop or reverse, depending on the direction gate is traveling.
9. Make sure that any pinch point or potential entrapment are guarded by means of safety devices or like.
10. Warning placards need to be permanently mounted on **both** sides of gate(s).
11. Test all additional equipment connected to operator.
12. Make sure all wire connections are **securely** fastened.
13. Review typical maintenance on operator.
14. Schedule periodic maintenance on operator by qualified service technician.
15. Inquire about manufacturer's "operator warranty". (Warranty card included with operator.)
16. Inquire about **separate** "installation warranty" with installer.

*Installer Company Name, Address and Phone Number*

*Date of installation:* \_\_\_\_\_

# Warranty Policy

## 7 YEAR RESIDENTIAL / 5 YEAR COMMERCIAL SL3000UL™ LIMITED WARRANTY

The Chamberlain Group, Inc. ("Seller") warrants to the first purchaser of this product, for the structure in which this product is originally installed, that it is free from defect in materials and/or workmanship for a period of 7 year residential/ 5 year commercial from the date of purchase [and that the SL3000UL™ is free from defect in materials and/or workmanship for a period of 7 year residential/ 5 year commercial from the date of purchase]. The proper operation of this product is dependent on your compliance with the instructions regarding installation, operation, maintenance and testing. Failure to comply strictly with those instructions will void this limited warranty in its entirety.

If, during the limited warranty period, this product appears to contain a defect covered by this limited warranty, call **1-800-528-2806**, toll free, before dismantling this product. Then send this product, pre-paid and insured, to our service center for warranty repair. You will be advised of shipping instructions when you call. Please include a brief description of the problem and a dated proof-of-purchase receipt with any product returned for warranty repair. Products returned to Seller for warranty repair, which upon receipt by Seller are confirmed to be defective and covered by this limited warranty, will be repaired or replaced (at Seller's sole option) at no cost to you and returned pre-paid. Defective parts will be repaired or replaced with new or factory-rebuilt parts at Seller's sole option.

**ALL IMPLIED WARRANTIES FOR THE PRODUCT, INCLUDING BUT NOT LIMITED TO ANY IMPLIED WARRANTIES OF MERCHANTABILITY AND FITNESS FOR A PARTICULAR PURPOSE, ARE LIMITED IN DURATION TO THE 7 YEAR RESIDENTIAL/ 5 YEAR COMMERCIAL LIMITED WARRANTY PERIOD SET FORTH ABOVE [EXCEPT THE IMPLIED WARRANTIES WITH RESPECT TO THE SL3000UL™, WHICH ARE LIMITED IN DURATION TO THE 7 YEAR RESIDENTIAL/ 5 YEAR COMMERCIAL LIMITED WARRANTY PERIOD FOR THE SL3000UL™], AND NO IMPLIED WARRANTIES WILL EXIST OR APPLY AFTER SUCH PERIOD. Some States do not allow limitations on how long an implied warranty lasts, so the above limitation may not apply to you. THIS LIMITED WARRANTY DOES NOT COVER NON-DEFECT DAMAGE, DAMAGE CAUSED BY IMPROPER INSTALLATION, OPERATION OR CARE (INCLUDING, BUT NOT LIMITED TO ABUSE, MISUSE, FAILURE TO PROVIDE REASONABLE AND NECESSARY MAINTENANCE, UNAUTHORIZED REPAIRS OR ANY ALTERATIONS TO THIS PRODUCT), LABOR CHARGES FOR REINSTALLING A REPAIRED OR REPLACED UNIT, OR REPLACEMENT OF BATTERIES.**

**THIS LIMITED WARRANTY DOES NOT COVER ANY PROBLEMS WITH, OR RELATING TO, THE GARAGE DOOR OR GARAGE DOOR HARDWARE, INCLUDING BUT NOT LIMITED TO THE DOOR SPRINGS, DOOR ROLLERS, DOOR ALIGNMENT OR HINGES. THIS LIMITED WARRANTY ALSO DOES NOT COVER ANY PROBLEMS CAUSED BY INTERFERENCE. ANY SERVICE CALL THAT DETERMINES THE PROBLEM HAS BEEN CAUSED BY ANY OF THESE ITEMS COULD RESULT IN A FEE TO YOU.**

**UNDER NO CIRCUMSTANCES SHALL SELLER BE LIABLE FOR CONSEQUENTIAL, INCIDENTAL OR SPECIAL DAMAGES ARISING IN CONNECTION WITH USE, OR INABILITY TO USE, THIS PRODUCT. IN NO EVENT SHALL SELLER'S LIABILITY FOR BREACH OF WARRANTY, BREACH OF CONTRACT, NEGLIGENCE OR STRICT LIABILITY EXCEED THE COST OF THE PRODUCT COVERED HEREBY. NO PERSON IS AUTHORIZED TO ASSUME FOR US ANY OTHER LIABILITY IN CONNECTION WITH THE SALE OF THIS PRODUCT.**

Some states do not allow the exclusion or limitation of consequential, incidental or special damages, so the above limitation or exclusion may not apply to you. This limited warranty gives you specific legal rights, and you may also have other rights which vary from state to state.



