



FR1500A

Fingerprint reader

FR1500A is a stylish single-gang flush-mounted fingerprint reader designed exclusively for ZKTeco Atlas Bio (x60 Series) panels.

FR1500A features



Sleek Stylish Form Factor:

Flush-mounted stainless steel enclosure with slim and attractive design is ideal for both indoor & outdoor installations where aesthetics are very important.



Communication:

FR1500A connects only via RS485 to Atlas Bio (x60 Series) panels. FR1500A does not support Wiegand.



Easy Operation:

Once a user places their finger on the FR1500A their fingerprint is subsequently matched by the Atlas Bio (x60 Series) panel. FR1500A also provides Visual indication for acceptance/rejection of the fingerprint (and/or prox card) of the users.



Standard Reader:

- SilkID fingerprint sensor
- Built-in ZKTeco prox card reader
- Options for HID and Mifare card readers

Dimensions

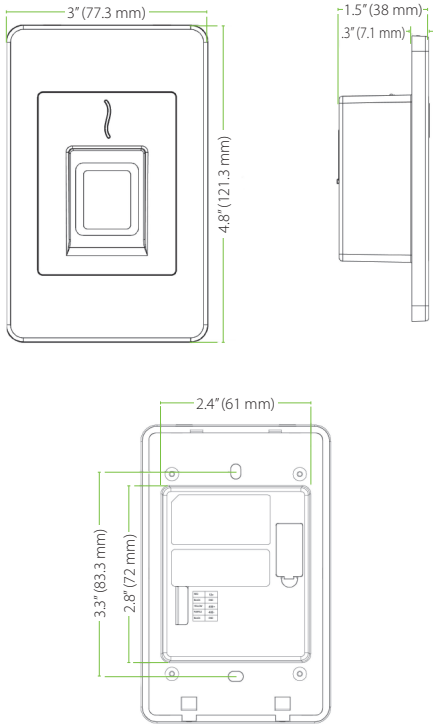

Installation with Atlas Bio (x60 Series) panel

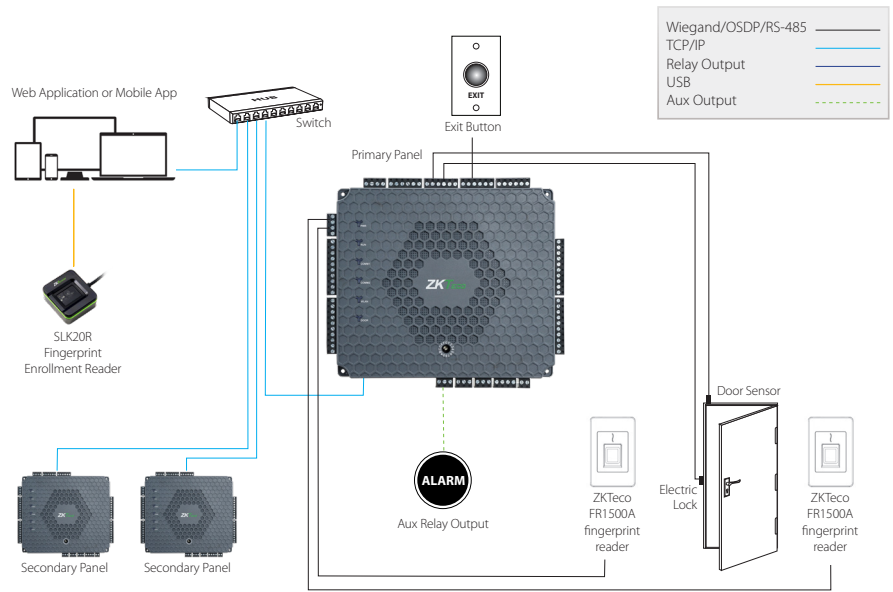

Specification

Communication

RS485 only to Atlasx60 panels

Power:

12V DC, 1A

Environment:

Operating Temp: 14° to 113° F (-10° to 45° C)

Operating Humidity: 20% to 80%

Optional Card Reader:

Mifare Card, HID 125 kHz card, HID iClass card

Dimensions

Length: 4.8 inches (121.3 mm)

Width: 3 inches (77.3 mm)

Depth: .3 inches (7.1 mm) exposed

1.5 inches (38.9 mm) behind wall

Part Numbers

FR1500A: with ZKTeco ID card reader

FR1500A-Mifare: with Mifare card reader

FR1500A-HID: with HID 125 kHz card reader

FR1500A-iClass: with HID iClass card reader

****For single-gang installations be sure to additionally order a ZKTeco single-gang adapter**

ZKTeco USA

1600 Union Hills Rd, Alpharetta, NJ 30005

Phone: (862) 505-2101 • Fax: (862) 204-5906 • sales@zktcouusa.com • www.zktcouusa.com

© Copyright 2019. ZKTeco Inc. ZKTeco Logo and ZKTeco USA Logo are registered trademarks of ZKTeco or a related company. All other product and company names mentioned are used for identification purposes only and may be the trademarks of their respective owners. All specifications are subject to change without notice. All rights reserved.